

Seminumerals, determiners and nouns in English

Takafumi Maekawa

Ryukoku University

Proceedings of the Joint 2016 Conference on Head-driven Phrase Structure
Grammar and Lexical Functional Grammar

Polish Academy of Sciences, Warsaw, Poland

Doug Arnold, Miriam Butt, Berthold Crysmann, Tracy Holloway King, Stefan
Müller (Editors)

2016

Stanford, CA: CSLI Publications

pages 422–441

Keywords: seminumerals, singular countable nouns, determiners, agreement, noun
phrase syntax

Maekawa, Takafumi. 2016. Seminumerals, determiners and nouns in English. In
Doug Arnold, Miriam Butt, Berthold Crysmann, Tracy Holloway King & Stefan
Müller (eds.), *Proceedings of the Joint 2016 Conference on Head-driven Phrase
Structure Grammar and Lexical Functional Grammar, Polish Academy of Sciences,
Warsaw, Poland*, 422–441. Stanford, CA: CSLI Publications. DOI: 10.21248/hpsg.2016.22.



Abstract

A singular countable noun in English normally requires a determiner and they should agree in number. However, there is a type of noun phrase, such as *those thousand teachers*, which does not conform to this generalisation. As a subtype of singular countable noun *thousand* requires a determiner, but the determiner has number agreement with the head noun *teachers*. The standard HPSG treatment, in which the determiner requirement and the determiner-noun agreement are both represented in the *SPR* specifications of the head noun, cannot capture this special agreement pattern. Our analysis, in which the determiner requirement and the determiner-noun agreement are dissociated from each other, can provide a straightforward account of the data.

1 Introduction

This paper addresses the issue of the syntactic relation between the determiner and the noun in a noun phrase. Especially we will focus on the syntax of singular countable nouns in English. The discussion will raise some fundamental questions about noun phrase syntax.

A singular countable noun in English is different from a plural countable noun and an uncountable noun in that it normally requires a determiner.¹

- (1) a. I haven't got *(a) *pen*.
b. There were *cats* in every room.
c. Her coat is made of pure *wool*. (Swan 2005:65-66)

The noun *pen* in (1a), which is a singular countable noun, requires a determiner to combine with, and the determiner *a* satisfies this requirement. A plural countable noun (1b) and an uncountable noun (1c), on the other hand, can stand on their own without a determiner.

When a determiner combines with a countable noun, they should agree in number.

- (2) a. this book /*this books
b. these books /*these book (Huddleston & Pullum 2002:352)

[†]I would like to thank the participants at HEADLEX 2016, especially Mary Dalrymple, Frank Van Eynde, John Payne and Nigel Vincent, for their feedback and discussions. I am grateful to anonymous reviewers for their constructive and valuable comments. Thanks are also due to Bob Borsley for his valuable comments on the earlier version of this paper. Any shortcomings are my responsibility. This research was supported by the Japan Society for the Promotion of Science (Grant-in-Aid for Scientific Research (C) 26370466).

¹We follow Huddleston & Pullum (2002:355) in assuming that the term 'determiner' refers to the following expressions: determinatives (*the tie*), determiner phrases (*almost every tie*), genitive NPs (*my tie*), plain NPs (*what colour tie*), PPs (*over thirty ties*).

In the ungrammatical examples in (2) the noun and the determiner do not agree in number.

The above observations lead to something like the following generalisation:

- (3) A singular countable noun in English requires a determiner and they should agree in number.

It is often assumed in HPSG that a determiner is a specifier of a head noun (Pollard & Sag 1994, Sag et al. 2003, Kim 2004, Kim & Sells 2008). In this assumption a singular count noun in English can be described as in (4).

$$(4) \left[\begin{array}{l} \text{HEAD} \\ \text{SPR} \end{array} \left[\begin{array}{l} \textit{noun} \\ \text{AGR} \boxed{1} [\text{NUM} \textit{sg}] \\ \langle [\text{AGR} \boxed{1}] \rangle \end{array} \right] \right]$$

(cf. Sag et al. (2003:107), Kim (2004:1114), Kim & Sells (2008:108))

(4) is a partial lexical description of a singular countable noun, stating that the latter has a specifier which agrees with it in number. The feature HEAD encodes such information as is propagated from a head to a phrase, including information about parts of speech. In (4) the value of this feature identifies this expression as a noun. The value of the HEAD feature includes the AGR (AGREEMENT) feature, whose value represents information about morpho-syntactic properties of the expression. The NUM (NUMBER) value represents the information about the grammatical number, and the *sg* value indicates that the word is morpho-syntactically singular. The SPR (SPECIFIER) feature shows that this expression has a specifier and indicates what kind of specifier it is.

Thus, the determiner requirement of a countable singular noun is encoded as a matter of valency. The boxed tag $\boxed{1}$ means that the specifier has the same AGR value as the head noun, representing determiner-noun agreement. (4) captures generalisation (3) and accounts for the unacceptability of (1a) **(a) pen* and (2) **this books/*these book*: the former lacks a specifier and the latter NPs do not show determiner-noun agreement.

It is possible to say that in the standard HPSG treatment of a singular countable noun in (4), the determiner requirement and the determiner-noun agreement are both represented in the SPR specifications of the head noun.

In this paper we will first argue that the numeral quantifiers in (5), which we argue to be subtypes of count nouns, cannot be captured by the standard treatment in (4).

- (5) a. those *thousand* teachers
(BYU-BNC²: GUR W_ac_polit_law_edu)

²Davies (2004-)

- b. these *hundred* women (BYU-BNC: FL5 S_brdcast_discussn)

Then we will argue that a satisfactory account of the data is possible within the framework in which prenominal elements such as determiners and numerals are non-heads selecting a head. In this approach the determiner requirement and the determiner-noun agreement are dissociated from each other (Van Eynde (2006), Allegranza (1998)).

Following Jackendo (1977:126), we will assume that there are two varieties of numeral quantifiers, which will be called 'cardinals' and 'seminumerals', respectively. Cardinals are numerals such as *two* and *ten*, which do not require a determiner before them.

- (6) (the/these/those) two (cats)

Seminumerals are words such as *hundred*, *thousand*, *million*, *billion*, *trillion* and *dozen*, which should be preceded by a determiner.

- (7) *(the/these/those/a) hundred (cats)

In this paper we will mainly focus on seminumerals, but cardinals are also mentioned in comparison with seminumerals.

The organisation of this paper is as follows. In section 2 we will introduce the data which are problematic for the standard HPSG treatment of noun phrase syntax. In section 3 we will look at some possible analyses, and we will argue that they include important weaknesses. Section 4 and 5 present our claim that the seminumerals are functors, and we will see how it is able to account for the facts. In section 6 we will also look at some data to which we can provide much the same explanation as seminumerals and other data which are no problem to our analysis. In section 7 we will briefly discuss some remaining issues. Section 8 is the conclusion.

2 Problems

Before pointing out the problems that the numerically quantified NPs in (5) pose, we will show that seminumerals are subtypes of countable nouns. First, like a singular countable noun as in (1a), the singular form of seminumerals needs a determiner in order to be grammatical.

- (8) a. Today there are a dozen. (COCA³: 1992 MAG Ebony)
b. *Today there are dozen.

Second, like a plural countable noun as in (1b), the plural form of seminumerals does not require a determiner.

- (9) There are dozens. (COCA: 1993 FIC Mov:Arcade)

³Corpus of Contemporary American English (Davies 2008-)

These observations lead to a conclusion that seminumerals are subtypes of countable nouns. We can thus expect that seminumerals in singular have much the same lexical properties as (4).⁴

Given that seminumerals are subtypes of countable nouns with the basic structure in (4), they might be analysed to have the following properties.

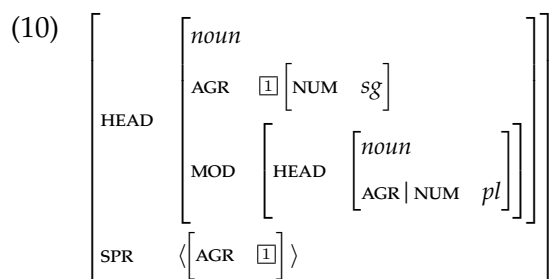

Here it is assumed that a seminumeral has a specifier which agrees with it and that it modifies a plural noun via the MOD feature. In *thousand teachers*, for example, *a thousand* is treated as an adjunct of *teachers*.

The NPs in (5), repeated below, pose challenges for (10).

- (11) a. those *thousand* teachers
 b. these *hundred* women [= (5)]

In the NPs in (11) the only possible determiner that can satisfy the determiner requirement of the seminumeral is the one just before it: *those* in (11a) and *these* in (11b).

- (12) a. *(those) thousand teachers
 b. *(these) hundred women

Since a seminumeral is a type of countable common noun, the singular form requires a determiner. (12a) and (12b) show that the determiner is obligatory. Since *teachers* and *women* are plural nouns, they do not require their own determiner. We can conclude that the determiner is required by the seminumeral (See also Hudson (2004:36)).

⁴However, seminumerals behave differently from typical countable nouns in the following respects. First, they combine with a noun without any intermediate element such as a preposition.

- (i) a dozen *(of) cats
 (ii) a pair *(of) cats

Second, seminumerals should be singular even when they combine with a numeral denoting a number larger than one.

- (iii) two hundred / *two hundreds
 (iv) two cats / *two cat

However, note that there is no number agreement between the determiner and the seminumeral: the seminumeral is singular but the determiner is plural. Instead, the determiner agrees with the plural noun after the seminumeral.

- (13) a. *those thousand teacher
 b. *these hundred woman

It is clear, then, that the NPs in (5) do not have the properties in (10).⁵

3 Possible Analyses

One possible analysis would be to propose that the specifier agrees with the plural noun that the seminumeral modifies, giving (14) in place of (10).

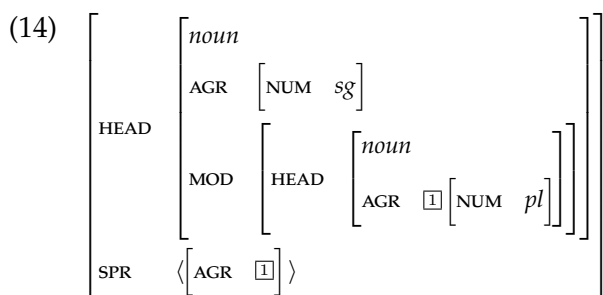

However, examples like those in (15), where the determiners are singular, pose a problem.

- (15) a. that thousand pounds (BYU-BNC: KCX S_conv)
 b. this hundred houses (BYU-BNC: J8G S_interview_oral_history)

The examples in (15) have singular determiners but have plural heads. Thus, there is no number agreement between the specifier (*that/this*) and the head noun (*pounds/houses*). Accordingly, we will not pursue this analysis.

Another possibility would be to propose that seminumerals are ‘weak heads’ (Tseng 2002, Abeillé et al. 2006, Przepiórkowski 2013) or ‘transparent heads’ (Flickinger 2008). With these mechanisms, it is possible to preserve

⁵Jackendo (1977:133) assumes that the underlying structure of *those dozen weeks* is *those a dozen of weeks*, where the plural determiner is in the specifier position of *weeks* and the seminumeral has its own determiner *a*. (This underlying form undergoes a couple of transformations (i.e. Pseudopartitive *a*-Deletion and Numeral *of*-Deletion) to obtain the surface form.) Under these assumptions it is possible to avoid the problems discussed above: the plural determiner agrees with the head noun because they are in the determiner-head relationship; the determiner requirement of the seminumeral is satisfied by its own underlying determiner *a*. However, this analysis cannot accommodate the fact observed in (12a). (12a) shows that the determiner is obligatory although *teachers* is a plural countable noun, which normally does not require its own determiner. This casts doubt on the assumption that *those* is the specifier of *weeks*.

some important properties of their complement on the phrase. This propagation of information from non-heads to phrases can account for the data in (5) if we assume that seminumerals preserve the grammatical number of the complement on the phrase.

However, examples like those in (15) pose a problem for analyses along these lines too. In (15) the seminumeral has a singular determiner. The seminumeral inherits the plural number from its complement and passes it to the phrase. The plurality of the phrase does not match the singular determiner. We conclude, then, that the weak/transparent head approach is unsatisfactory.

4 Prenominal Elements as Functors

We will turn to an analysis which we think provides a satisfactory account of the data. In this analysis determiners and seminumerals are functors: non-heads which select the head.

In recent HPSG, a notion of functor has been introduced as an alternative to the dichotomy between modifiers and determiners (Van Eynde 2006, Allegranza 1998). In languages such as Italian, the determiners and the adjectives have the same morphological variation and the same patterns of agreement.

- (16) *questa bella bambina* [Italian]
 this-SG.FM beautiful-SG.FM child-SG.FM
 ‘this beautiful child’ (Van Eynde 2007:419)

The singular feminine determiner *questa* ‘this’ selects a singular feminine nominal as does the singular feminine adjective *bella* ‘beautiful’. The dichotomy between modifiers and determiners does not capture such shared properties. For this reason, prenominal elements, such as adjectives and determiners, are uniformly treated as functors.

We will adopt the functor analysis of determiners and assume that singular determiners such as *this* have the following syntactic properties (Van Eynde 2006).

- (17) *this*:
- $$\left[\begin{array}{l} \text{HEAD} \\ \text{MRK} \end{array} \left[\begin{array}{l} \text{determiner} \\ \text{AGR } \boxed{1} \left[\text{NUM } \text{sg} \right] \\ \text{SEL } \left\langle \text{HEAD } \left[\begin{array}{l} \text{noun} \\ \text{AGR } \boxed{1} \end{array} \right] \right\rangle \end{array} \right] \right]$$
- marked*

The information about selection is indicated by the SEL (SELECT) feature of a non-head, which represents the constraints which a non-head daughter imposes on the head daughter. The SEL value of (17) shows that this word selects a singular noun.

MARKING (MRK) indicates whether the expression involves a determiner or it can stand alone without these elements. The MRK value is *marked* if the expression contains a determiner or it itself is a determiner, and *unmarked* otherwise. Plural nouns and abstract nouns are [MRK *bare*] because they can stand alone without a determiner. Singular countable nouns such as *pen* and *week* have an *incomplete* value because they require a determiner

The AGR value [1] [NUM *sg*] shared between *this* and its head noun means determiner-noun agreement between them. The partial description of *these* is the same as (17) except for the AGR value: as a plural determiner, the value is [NUM *pl*].

Singular countable nouns such as *pen* have the following syntactic properties.

$$(18) \text{ pen: } \left[\begin{array}{l} \text{HEAD} \left[\begin{array}{l} \textit{noun} \\ \text{AGR} | \text{NUM} \quad \textit{sg} \end{array} \right] \\ \text{MRK} \quad \textit{incomplete} \end{array} \right]$$

The NUM value of a singular noun is *sg*. The *incomplete* value of the MRK feature indicates that a singular countable noun requires a determiner to combine with.

A determiner and a nominal combine to form a head-functor phrase, which is subject to the following constraint on *head-functor-phrase* (*hd-funct-ph*) (Van Eynde 2006, Allegranza 1998).

(19) Constraint for head-functor phrase (Van Eynde 2006:164,166)

$$\textit{hd-funct-ph} \rightarrow \left[\begin{array}{l} \text{MRK} \quad [1] \\ \text{DTRS} \quad \left\langle \left[\begin{array}{l} \text{MRK} \quad [1] \\ \text{SEL} \quad \langle [2] \rangle \end{array} \right], [3] \left[\text{SYNSEM} \quad [2] \right] \right\rangle \\ \text{H-DTR} \quad [3] \end{array} \right]$$

Constraint (19) states that in a head-functor phrase the non-head daughter selects a head daughter, and the MRK value of the mother is identical to that of the non-head daughter.

Let us consider how generalisation (3) is captured in this approach. (20) shows how functor *this* combines with a singular countable noun.

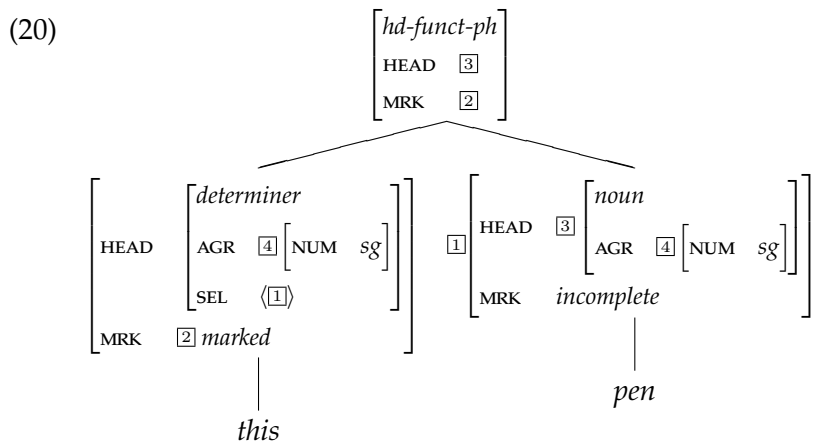

The combination of *this* and *pen* is an instance of a head-funct phrase, in which *this* selects the head noun and the MRK value *marked* is inherited to the mother node. The AGR|N value of *pen* is *sg*, indicating that it is a singular nominal. The AGR value [4] shared between *this* and its head noun means determiner-noun agreement between them. The MRK feature of *pen* has a value whose type is *incomplete*, which means that the word is incomplete on its own, requiring some sort of determiner. The HEAD value is propagated from the head daughter to the mother node. This propagation is due to the constraint on phrases of type *headed-phrase* (*hd-ph*), which is a supertype of *hd-funct-ph*.

In this approach generalisation (3) is captured in terms of two separate specifications. First, the determiner requirement of a singular countable noun is represented by the *incomplete* value of the MRK feature of the head nominal. Second, the determiner-noun agreement is represented by the shared value of the AGR|N feature between the determiner and the head noun.

The difference between the head-funct analysis in (20) and the standard HPSG treatment in (4) can be summarised as follows. In standard HPSG the determiner requirement and the determiner-noun agreement are both represented in the *SPR* specifications of the head noun. In the head-funct analysis, on the other hand, the determiner-noun agreement and the determiner requirement are dissociated from each other.

5 Seminumerals as Functors

Based on the earlier observations that seminumerals are subtypes of countable nouns (section 2), we propose that the singular form of a seminumeral has the following syntactic properties.

(21) *hundred*:

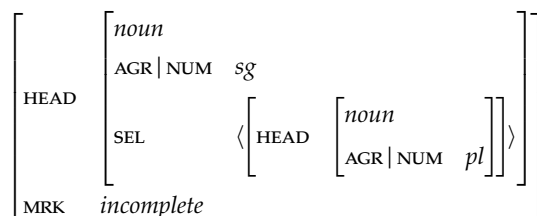

This lexical entry of a seminumeral is the same as that of a singular countable noun given in (18), except that it has a SEL specification. The SEL value in (21) indicates that the seminumeral selects a plural noun. The MRK feature of seminumerals has a value whose type is *incomplete*, which means that the word is incomplete on its own, requiring some sort of determiner.

Our syntactic analysis of *those thousand teachers* is given in (22).

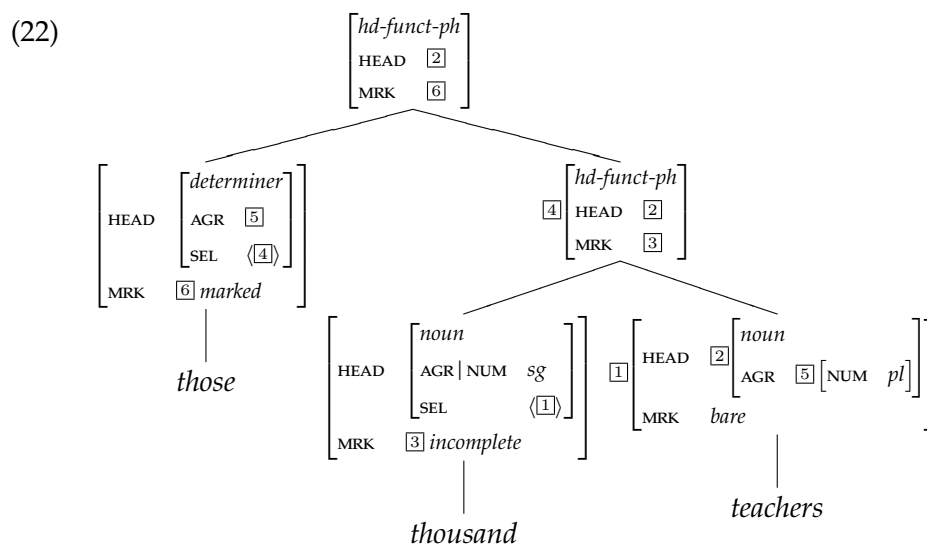

The combination of *thousand* and *teachers* is an instance of a head-functor phrase. In (22) *thousand* as a functor daughter selects the head daughter *teachers*, and the MRK value of the functor daughter is propagated to the mother node. The MRK value is of type *incomplete*, which means that the expression is incomplete on its own, requiring some determiner. The *pl* value of AGR|N, which is propagated from *teachers* via the HEAD feature, enables this phrase to combine with the plural determiner *those*.

It should be noted that the determiner requirement of the seminumeral is fully satisfied by the plural determiner. Agreement mismatch does not occur, however, because the determiner and the seminumeral are not in the determiner-head relationship. The determiner agrees with the plural noun *teachers* via the AGR|N feature.

Our approach can account for the agreement pattern with the verb when the construction in question is a subject.

- (23) a. (...), and when he's drunk **those hundred things** *become* a thousand. (COCA: 2011 FIC Bk:AftertasteNovel)
 b. (...) **these thousand pages** *have* been gathered, (...) (COCA: 2011 FIC Bk:GreatCircleMay eld)
 c. **These dozen men** *have* been close enough to hear them. (COCA: 1995 MAG SportingNews)

As (22) shows, the head of the whole construction is the plural noun after the seminumeral. The plurality of the head noun accounts for the plural agreement with verb, illustrated by the examples in (23).

We can argue that examples like (24) also have structures like (22).

- (24) a. all thousand stones (BNC: CAM W_ ct_prose)
 b. all hundred modifications (COCA: 2003 SPOK NPR_ATCW)

All requires a plural noun and in the examples in (24) the head nouns *stones* and *modifications* satisfy this requirement, respectively.

Our functor analysis of seminumerals can give an account of the data in (15), in which the seminumeral takes a singular determiner.

- (25) a. that thousand pounds
 b. this hundred houses [= (15)]

(26) is a structure we propose for (25b) *this hundred houses*.

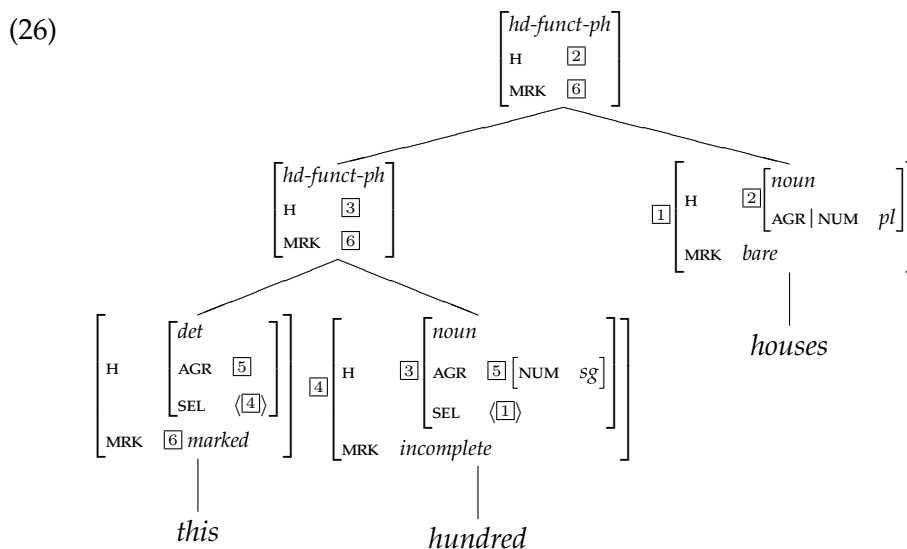

In this construction the seminumeral *first* combines with the determiner as a head-funct phrase. The determiner should be singular because its head, *hundred*, is [AGR | N sg]. The SEL value of *hundred* is inherited to the mother node via the HEAD feature. The phrase *this hundred* combines with the head noun *houses* to form another head-funct phrase.

The subject-verb agreement shown in (27) can be accounted for in terms of the number of the head noun.⁶

- (27) Let's see what **this hundred women** *make* of the question, do men hate women? (BYU-BNC: FL7 S_brdcast_discussn)

The head is the plural noun *women* in (27). This accounts for the plural agreement with the verb.

The following NPs have much the same structure as (26).

- (28) a. (...) **a dozen men** *move* back and forth, (...) (BYU-BNC: G0F W_ ct_prose)
b. In Bombay, for instance, **every thousand people** *have* only 0.1 hectares of open space – and this includes tra c islands. (BYU-BNC: B7E W_non_ac_nat_science)

Determiners *a* and *every* only combine with a singular nominal. In (28) they combine with the seminumeral which is a subtype of a singular common noun. The resulting phrase combines with the head noun.

We have illustrated that our analysis can accommodate the data which are problematic to the other analyses we discussed in section 3.

6 Further Data

We have argued that a seminumeral is a functor selecting a head and accounted for the agreement between the determiner and the head noun. In this section we will present some pieces of data which are closely related to seminumeral.

6.1 Sort-nouns

The syntactic behaviour of seminumeral which we have seen so far is very similar to the type of NP shown in (29).

- (29) a. these *sort* of skills
b. those *kind* of pitch changes
c. these *type* of races (Keizer 2007:170)

⁶If the head noun of the subject is a measure noun, the plural subject combines with a singular verb.

- (i) **Five pounds** *is*/**are* a lot of money. (Hudson 1999:174)

The singular verb in the following example can be accounted for along the same lines.

- (ii) ..., but **that thousand pounds** *is* not a sum that the firm can afford to lose. (BYU-BNC: EV1 W_ ct_prose)

We call the nouns *sort*, *kind* and *type* collectively as *sort-nouns*. The *sort-nouns* are countable nouns, and those in (29) are singular. Note that they are preceded by a plural determiner. As in the case of seminumerals, the determiner requirement of the singular *sort-noun* is satisfied by the plural determiner. The determiner agrees with the noun following *of*.

- (30) a. *these sort of skill
 b. *those kind of pitch change
 c. *these type of race

Another similarity is that this construction causes plural agreement with the verb.

- (31) Well I'd actually expect that **those sort of courses** *are/*is* very uh heavily subscribed uh, heavy just like **these sort of problems** *are/*is* very hard to solve. (Keizer (2007:175); adapted from ICE-GB)

These similarities lead us to expect that the constructions in (29) have much the same structure as (22). Maekawa (2015) argues that the NPs in (29) have structures like the following .

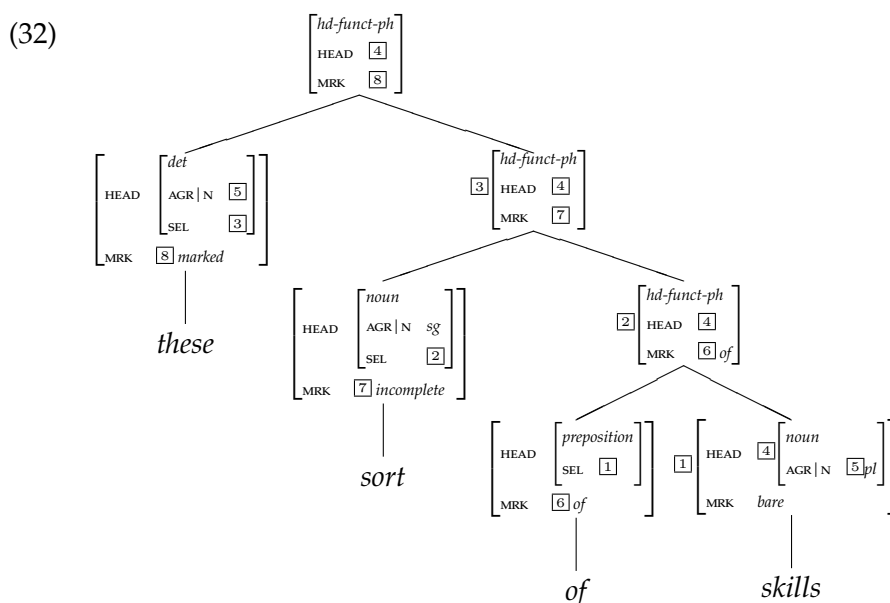

Assuming that preposition *of* is a functor (Van Eynde 2005), the combination of the preposition and *skills* is a head-funct-ph, in which the former selects the latter. Preposition *of* has the MRK feature whose value is *of*. This value is inherited from *of* to *of skills*. The *sort-noun* in this construction is a functor with much the same properties as (21). As a functor, it selects the *of*-marked phrase via the SEL value [2]. In this head-funct-ph the *sort-noun* is a non-head daughter, and the head-daughter is *of skills*. The HEAD value of the resulting phrase comes from the head daughter. The *pl*

value of $AGR | N$, which is propagated from *skills* via the $HEAD$ feature, enables this phrase to combine with the plural determiner *these*. The combination of the determiner with the head nominal is also an instance of a head-functor phrase, and the MRK value *marked* is inherited from *these* to *these sort of skills*. The head of the whole construction is the plural noun after *of*, and this explains plural agreement with the verb.

Moreover, the determiner can also be singular but have plural agreement with the verb.

- (33) a. **This kind of rankings** *have* given ammunition to conservatives
 (...) (COCA: 2001 NEWS CSMonitor)
 b. (...) **this type of women** *like* to be around rich and powerful men.
 (COCA: 2008 SPOK Fox_Gibson)

This fact can be captured along the same lines as (25), where the seminumeral takes a singular determiner but have a plural verb. The subject noun phrases in (33) have structures like the following.

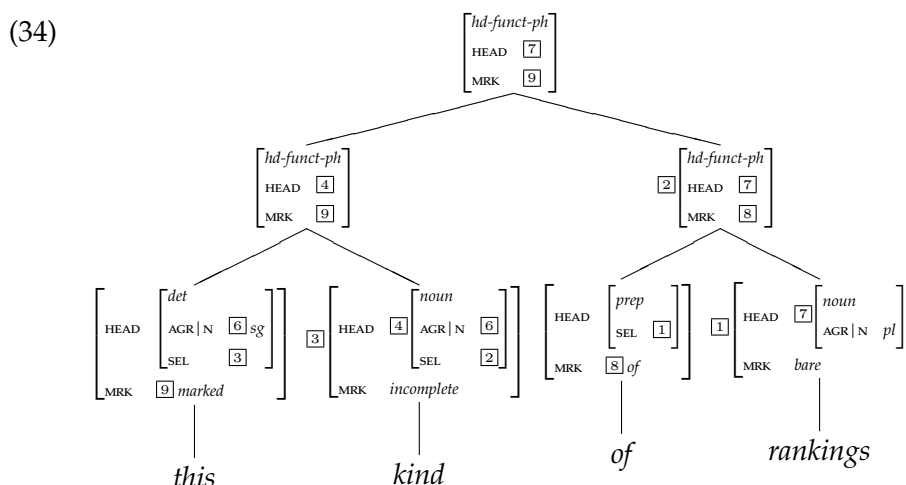

In (34) the *sort-noun* *kind* rst combines with the determiner to form a head-functor phrase. They have singular agreement because the head (*sort*) is singular. The SEL value of *sort* is inherited to the mother node because it is a $HEAD$ feature. The phrase *this sort* combines with the *of*-marked phrase to form another head-functor phrase. Like (32), the head of the whole phrase is the head-daughter of the *of* phrase. This accounts for plural agreement with the verb.

For more details of a head-functor analysis of these constructions, see Maekawa (2015).

6.2 Cardinals

In this subsection we will turn to cardinals, which are another type of numeral exemplified by words like *three* and *ten*. We will argue that the dif-

ference between seminumerals and cardinals is small and most part of the analysis given to seminumerals can be applied to cardinals as well.

Seminumerals and cardinals differ only in that the former require a determiner but the latter need not have one.

- (35) a. *(the) hundred weeks
 b. (the) three weeks

Cardinals can have much the same range of determiners as seminumerals.

- (36) a. *those* three weeks
 b. *that* three weeks
 c. *every* three weeks
 d. *all* three weeks (Jackendo 1977:132)

- (37) a. *those* thousand teachers [= (5a)]
 b. *that* thousand pounds [= (25a)]
 c. *every* thousand people [= (28b)]
 d. *all* thousand stones [= (24a)]

Based on the above observations we can propose something like the following partial lexical description of a cardinal.

- (38) *three*:
- $$\left[\begin{array}{l} \text{HEAD} \\ \text{MRK} \end{array} \left[\begin{array}{l} \textit{noun} \\ \text{AGR} | \text{NUM} \quad \textit{sg} \\ \text{SEL} \quad \langle \left[\text{HEAD} \left[\begin{array}{l} \textit{noun} \\ \text{AGR} | \text{NUM} \quad \textit{pl} \end{array} \right] \right] \rangle \\ \textit{bare} \end{array} \right. \right. \right]$$

The SEL value in (38) indicates that the cardinal selects a plural noun. The MRK feature has a value whose type is *bare*, which means that a cardinal does not require a determiner to be used in NP positions. This description of a cardinal differs from that of seminumerals only in the specification of the MRK value, which is *bare* for cardinals but *incomplete* for seminumerals. That captures the differences shown in (35).

6.3 Plural Seminumerals

In this subsection we will have a look at plural seminumerals and compare them with seminumerals in singular.

It is possible to say that plural seminumerals have quite different syntactic properties from their singular counterparts. First, a plural seminumeral

cannot select a plural noun, but instead they are followed by a prepositional phrase headed by *of*.⁷

- (39) a. hundreds *(of) cats
 b. a hundred (*of) cats

Second, singular and plural seminumerals differ in the possibility of extraction, according to Kayne (2005:160).

- (40) a. (?) What (else) does he have hundreds of?
 b. *What (else) does he have a hundred? (Kayne 2005:160)

The above data show that a plural seminumeral can allow extraction of the noun after *of*, but it is impossible to extract a noun after the singular seminumeral.

Based on these observations, we can argue that the partial lexical description of a plural seminumeral is something like the following.

- (41) *hundreds*:
- $$\left[\begin{array}{l} \text{HEAD} \\ \text{MRK} \end{array} \left[\begin{array}{l} \textit{noun} \\ \text{AGR} \mid \text{NUM} \quad \textit{pl} \\ \text{COMP} \quad \langle \left(\left[\text{HEAD} \left[\begin{array}{l} \textit{preposition} \\ \text{FORM} \quad \textit{of} \end{array} \right] \right] \right) \rangle \\ \textit{bare} \end{array} \right. \right]$$

The COMP value in (41) indicates that a plural seminumeral optionally takes a prepositional phrase as its complement. The optionality of the PP is illustrated by the following example.

- (42) Hailes-Valentine's study required only 12 patients; others involve hundreds. (COCA: 1990 NEWS USAToday)

The PP complement is constrained to have *of* as its head ([FORM *of*]) (Sag et al. 2003:316), which captures the (un)grammaticality of (39a).

The claims that *of* in this construction is a complement-taking preposition and that the *of*-phrase is a complement of the seminumeral account for the extraction of the noun seen in (40a). We assume that the SLASH value of argument-taking words is determined in terms of the SLASH values of their arguments (Ginzburg & Sag 2001:168). This allows extraction of complements. Extraction is impossible in (40b) because the extracted element is not an argument of the seminumeral: it is the head which the seminumeral selects.

The MRK value of a plural seminumeral is *bare*, which means that the word can occur in a sentence with or without a determiner.

⁷We postulate two lexical entries for *of*: a complement-taking preposition as in (39a) and a functor preposition discussed in 6.1.

(43) (these) hundreds / thousands / dozens of patients

7 Remaining Issues

We have given an analysis of the syntactic relation of seminumerals, determiners and nouns in English, but there are some remaining issues.

One such issue is the spurious ambiguity that structures like (44) have.

(44) the hundred people

The determiner *the* is ambiguous and can be either singular or plural. The NP in (44) has two analyses, which corresponds to (22) and (26), respectively. In the former structure the seminumeral combines with the head noun and the resulting phrase then combines with *the*. In the latter structure the seminumeral combines with *the* first. The determiner *the* causes such an ambiguity, but it is not clear whether this results in any difference in interpretation.

Another issue is how this analysis can be applied to similar constructions in other languages. In Polish, for example, numerals show a complicated behaviour concerning case and number. In the subject NP in (45) the numeral is accusative and the noun is genitive. The determiner can be either accusative or genitive. The verb is third person, singular and neutral.

(45) Te / Tych tysiąc osób już
these-PL,ACC / these-PL,GEN thousand-ACC people-GEN already
przyszło. [Polish]
came-3RD,SG,NEUT
'The thousand people already came' (Przepiórkowski 1999:195)

These issues should be left for future research.

8 Conclusion

Let us summarise the discussion. In English a singular countable noun normally requires a determiner and they should agree in number. It looks, however, as if a seminumeral in examples like *those thousand teachers* does not conform to this generalisation: it is a singular countable noun that requires a determiner, but the determiner satisfying this requirement does not agree with it. Instead, the determiner agrees with the noun following the seminumeral. We argued that the functor treatment of seminumerals can provide a satisfactory account of the data. We also suggested that examples such as *that thousand pounds*, in which the singular determiner agrees with the seminumeral, can be accommodated in our analysis.

In HPSG it has been normally assumed that the *SPR* value represents the constraints which the head imposes on the determiner, including both

the determiner requirement of a singular countable noun and determiner-noun agreement. In the head-functor analysis of determiner-noun relation, however, the determiner requirement and determiner-noun agreement are represented separately: the former is represented as the *incomplete* value of the MRK feature of the head daughter, and the latter is encoded as part of constraints which the determiner imposes on the head daughter. These mechanisms interact to allow the plural determiner to satisfy the determiner requirement of a singular seminumeral and to agree with the plural head noun in examples like *those thousand teachers*.

References

- Abeillé, Anne, Olivier Bonami, Danièle Godard & Jesse Tseng. 2006. The syntax of French *à* and *de*: An HPSG analysis. In Patrick Saint-Dizier (ed.), *Syntax and Semantics of Prepositions* (Text, Speech and Language Technology 29), 147–162. Springer Verlag.
- Allegranza, Valerio. 1998. Determiners as functors: NP structure in Italian. In Sergio Balari & Luca Dini (eds.), *Romance in HPSG*, 55–108. Stanford: CSLI Publications.
- Davies, Mark. 2004–. BYU-BNC (Based on the British National Corpus from Oxford University Press). <http://corpus.byu.edu/bnc/>.
- Davies, Mark. 2008–. The Corpus of Contemporary American English: 450 Million Words, 1990-Present. <http://corpus.byu.edu/coca/>.
- Flickinger, Dan. 2008. Transparent heads. In Stefan Müller (ed.), *The Proceedings of the 15th International Conference on Head-Driven Phrase Structure Grammar*, 87–94. Stanford: CSLI Publications. <http://csli-publications.stanford.edu/HPSG/9/>.
- Ginzburg, Jonathan & Ivan A. Sag. 2001. *Interrogative investigations: the form, meaning, and use of english interrogatives*. Stanford, California: CSLI Publications. <http://csli-publications.stanford.edu/site/1575862786.html>.
- Huddleston, Rodney & Geoffrey K. Pullum. 2002. *The Cambridge Grammar of the English Language*. Cambridge: Cambridge University Press.
- Hudson, Richard. 1999. Subject-verb agreement in English. *English Language and Linguistics* 3(2). 173–207.
- Hudson, Richard. 2004. Are determiners heads? *Functions of Language* 11(1). 7–24.

- Jackendo, Ray. 1977. *X' Syntax: A Study of Phrase Structure*. Cambridge, Mass.: MIT Press.
- Kayne, Richard S. 2005. On some prepositions that look DP-internal. In *Movement and Silence*, chap. 7, 136–175. Oxford: Oxford University Press.
- Keizer, Evelien. 2007. *The English Noun Phrase*. Cambridge: Cambridge University Press.
- Kim, Jong-Bok. 2004. Hybrid agreement in English. *Linguistics* 42(6). 1105–1128.
- Kim, Jong-Bok & Peter Sells. 2008. *English Syntax: An Introduction*. Stanford: CSLI Publications.
- Maekawa, Takafumi. 2015. 'Agreement mismatch' between sort/kind/type and the determiner. In Stefan Müller (ed.), *Proceedings of the 22nd International Conference on Head-Driven Phrase Structure Grammar, Nanyang Technological University (NTU), Singapore*, 136–156. Stanford, CA: CSLI Publications. <http://csli-publications.stanford.edu/HPSG/2015/maekawa.pdf>.
- Pollard, Carl J. & Ivan A. Sag. 1994. *Head-driven Phrase Structure Grammar*. Chicago: University of Chicago Press.
- Przepiórkowski, Adam. 1999. *Case Assignment and the Complement-Adjunct Dichotomy: A Non-conjunctural Constraint-based Approach*. Germany: Universität Tübingen dissertation.
- Przepiórkowski, Adam. 2013. The syntax of distance distributivity in Polish: Preserving generalisations with weak heads. In Stefan Müller (ed.), *Proceedings of the 20th International Conference on Head-driven Phrase Structure Grammar, Freie Universität Berlin*, 161–181. <http://csli-publications.stanford.edu/HPSG/2013/przepiorkowski.pdf>.
- Sag, Ivan A., Thomas Wasow & Emily M. Bender. 2003. *Syntactic Theory: A Formal Introduction: Second Edition*. Stanford: CSLI Publications.
- Swan, Michael. 2005. *Practical English Usage: Third Edition*. Oxford: Oxford University Press.
- Tseng, Jesse L. 2002. Remarks on marking. In Frank Van Eynde, Lars Hellan & Dorothee Beermann (eds.), *Proceedings of the 8th International Conference on Head-driven Phrase Structure Grammar*, 267–283. Stanford: CSLI Publications. <http://csli-publications.stanford.edu/HPSG/2/>.
- Van Eynde, Frank. 2005. A head-driven treatment of asymmetric coordination and apposition. In Stefan Müller (ed.), *The proceedings of the 12th*

international conference on head-driven phrase structure grammar, department of informatics, university of lisbon, 396–409. Stanford: CSLI Publications. <http://csli-publications.stanford.edu/HPSG/6/>.

Van Eynde, Frank. 2006. NP-internal agreement and the structure of the noun phrase. *Journal of Linguistics* 42(1). 139–186.

Van Eynde, Frank. 2007. The big mess construction. In Stefan Müller (ed.), *The Proceedings of the 14th International Conference on Head-driven Phrase Structure Grammar*, 415–433. Stanford: CSLI Publications. <http://csli-publications.stanford.edu/HPSG/8/>.