

Coordination of unlikes without unlike categories

Rui P. Chaves 

Centro de Linguística da Universidade de Lisboa

Proceedings of the 13th International Conference on
Head-Driven Phrase Structure Grammar

Linguistic Modelling Laboratory,
Institute for Parallel Processing,
Bulgarian Academy of Sciences,
Sofia,
Held in Varna

Stefan Müller (Editor)

2006

Stanford, CA: CSLI Publications

pages 102–122

Chaves, Rui P. 2006. Coordination of unlikes without unlike categories. In Stefan Müller (ed.), *Proceedings of the 13th International Conference on Head-Driven Phrase Structure Grammar, Varna*, 102–122. Stanford, CA: CSLI Publications. DOI: 10.21248/hpsg.2006.6. 

Abstract

Several analysis of Coordination of Unlikes have been proposed within the HPSG framework. In some of these approaches the possible combinations of ‘unlike categories’ are encoded in the grammar, while other accounts resort to an independently motivated ellipsis analysis. In this paper we provide further arguments in favor of the latter. However, some problematic cases of Coordination of Unlikes in certain S-adjointing constructions are left unaccounted for. We propose a general analysis of these S-adjointing constructions, and in doing so, the problematic coordination cases are predicted without the need for further assumptions.

1 Introduction

The data in (1) illustrate the phenomenon usually referred to as Coordination of Unlikes, in which constituents of different categories are apparently conjoined:

- | | |
|--|-----------|
| (1) a. Fred became wealthy and a Republican. | [AP & NP] |
| b. Sue is healthy and in good shape. | [AP & PP] |
| c. That was a rude remark and in very bad taste. | [NP & PP] |

There are several avenues of research for capturing this phenomenon in HPSG. A brief overview of previous proposals is given in §2, as well as several arguments in favor of ellipsis approaches. In §3 we discuss problematic cases of coordination of unlikes occurring in dangling phrases, which behave as apparent exceptions to Wasow’s Generalization (Pullum and Zwicky, 1986). We show in §4 that a proper treatment of these constructions suffices to obtain the problematic coordination data as a prediction. Finally, §5 provides concluding remarks about the paper.

2 Background

HPSG analysis of Coordination of Unlikes like the one in Pollard and Sag (1994) are essentially based in the GPSG analysis proposed in Sag et al. (1985), in which the coordination rule is allowed to underspecify the category of the mother node. This account ran into at least two problems. On the one hand, it did not rule out cases like the one below, due to Jacobson (1987):

- (2) *Pat grew and remained wealthy and a Republican.

[†]My thanks to Christiane Fellbaum, Ivan Sag, Palmira Marrafa, and Sara Mendes for their comments and suggestions about earlier drafts. Thanks also to the HPSG06 conference audience, in particular to Stefan Müller. None of the above necessarily endorse or reject the current proposal, nor share any responsibility for any errors or shortcomings. This research was supported by grant SFRH/BD/13880/2003 attributed by Fundação para a Ciência e a Tecnologia.

The issue here is that one of the conjoined arguments (in this case, *a Republican*) is not compatible with the selectional requirements of one of the conjoined functors (i.e. *grew*). In general, each conjoined argument must be compatible with each functor, a constraint which is often referred to as Wasow’s Generalization.

A secondary issue is that the above proposal clashed with the idea that HPSG descriptions are totally sort-resolved. Several theoretical alternatives have been put forth since then. For instance, Levy and Pollard (2002) propose to explicitly encode the possible part-of-speech combinations in a different kind of type lattice that is usually assumed in HPSG. However, this and related accounts such as Daniels (2002), entail a combinatorial explosion of types (Levy and Pollard 2001, 225), and require special-purpose lattice operations in order to cope with cases like (2).

A different strategy is pursued in Sag (2002). Here, the sort-resolvedness requirement for HPSG descriptions is abandoned, and a ‘ \leq ’ (*is-a-supertype-of*) constraint is introduced in the formalism with the purpose of imposing unification bounds. This is illustrated in the (simplified) lexical entry seen below in (3a):

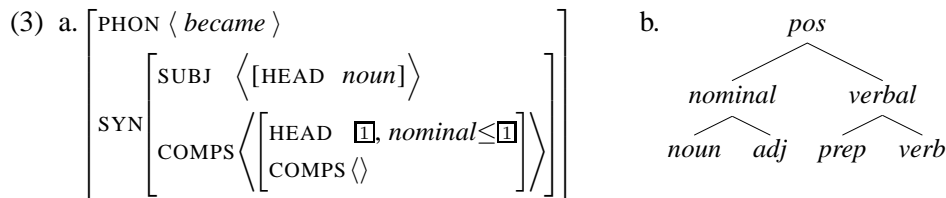

The verb ‘*to become*’ selects a subject NP and a complement of (at least) type *nominal* which is a supertype of *noun* and *adj(ective)*, according to the hierarchy in (3b). In turn, the coordination rule in Sag (2002) states that the category of the mother node must be the upper bound over the category assigned to each conjunct. Thus, a conjunction [AP & NP] is assigned the category *nominal*, which is now compatible with the valence requirements imposed by the verb:

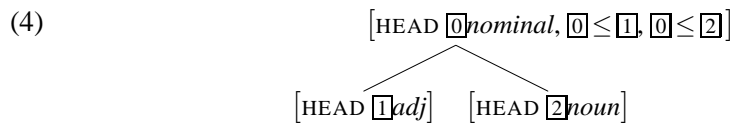

This allows the verb to take as complements APs, NPs, or conjunctions of AP and NP categories, such as ‘*Pat became [wealthy and a Republican]*’.

Verbs like ‘*to grow*’ on the other hand, specify for [COMPS ⟨AP⟩] and are therefore unable to take complements which are of a type more general than *adj*. Thus, phrases like [AP & NP], which are of type *nominal*, are not valid complements of ‘*grow*’ because the constraint $\boxed{0} \leq \boxed{2} \textit{noun}$ is violated: $\boxed{0}$ cannot be unified with *adj* because $\textit{adj} \not\leq \textit{noun}$. The use of type-underspecification keeps the number of nodes in the hierarchy much lower than in Levy and Pollard (2002), but, as Sag (2002) notes, each different kind of unlike category coordination still entails stipulating a new supertype in the *part-of-speech* hierarchy.

A second potential problem concerns the formal status of the ‘ \leq ’ constraint. Although its behavior is intuitive, it is not clear how much formal machinery must be added in order to maintain the monotonicity of constraint resolution in HPSG.

A more recent analysis is proposed in Yatabe (2004), in which the category of a coordination phrase is list-valued. As illustrated below in (5), a head feature ARGs is used to list the head values found in the local daughters:

$$(5) \left[\begin{array}{l} \text{PHON } \langle \textit{wealthy, and, a, republican} \rangle \\ \text{SYN } \left[\begin{array}{l} \text{HEAD } \left[\begin{array}{l} \text{CONJ } \textit{and} \\ \text{ARGS } \langle \textit{adj, noun} \rangle \end{array} \right] \end{array} \right] \end{array} \right]$$

A recursive relation $c(\alpha)$ is introduced in the verbal lexical entries with the purpose of traversing the ARGs list and ensuring that each conjunct is compatible with the verbal subcategorization specifications α . For instance, in a verb like ‘*to become*’ the HEAD value of the complement must satisfy the constraint $c(\textit{noun} \vee \textit{adj})$.

Notice that none of the above accounts offers any insight on why certain categories can be conjoined. The combinatorial possibilities are directly stipulated in the grammar: in one case these are encoded in the type hierarchy, and in the other case these are listed in lexical entries. Ideally, the theory should predict which are the eligible categories for Coordination of Unlikes in a given language. Also, the above analyzes introduce considerable complexity in the grammar, in type hierarchies and/or in special constraints that propagate non-locally in the descriptions.

Crysmann (2003) and Beavers and Sag (2004) propose a more general approach in which Coordination of Unlikes is the consequence of an independently motivated ellipsis operation, responsible for capturing Argument Cluster Coordination (henceforth ACC; often also referred to as Conjunction Reduction or Left-periphery Ellipsis). Consider the ACC examples seen below.

- (6) a. John gave a book to Mary, and a record to Sue.
 b. John gave Mary a book, and to Peter a record.
 c. I gave Mary a coloring book, and new roller skates to her sister.
 d. I sent a postcard to your brother on Monday and to your sister on Tuesday.
 e. That boy and girl are really no different from each other.

The cases in (6a–d) can be obtained via a standard VP coordination rule in which the verb is elided in the non-initial conjunct (e.g. [*gave Mary a book*] and [~~*gave*~~ *to Peter a record*]). The example in (6e) is also interesting because of the syntactic and semantic behavior of the subject NP. The pronoun must agree with the nominal structure it attaches to (e.g. *those* / **that boys are similar*), and the VP triggers a reciprocal reading which is only felicitous with a plural subject. The pattern in (6e) can be accounted for straightforwardly if one takes the subject to be a standard NP coordination structure in which the pronoun is elided: [*that boy*] and [~~*that*~~ *girl*].

For perspicuity, we present a (simplified) coordination construction in Figure 1 (based in Yatabe (2001), Crysmann (2003) and Beavers and Sag (2004)) that allows for left-peripheral ellipsis. This construction resorts to DOM(AIN) lists, which

are used for linearization purposes in HPSG (see Kathol (2000) for instance). Ellipsis is obtained because each daughter domain is split in several DOM lists, but some lists are absent from the mother node (in this case, the left-peripheral list $\boxed{A'}$):

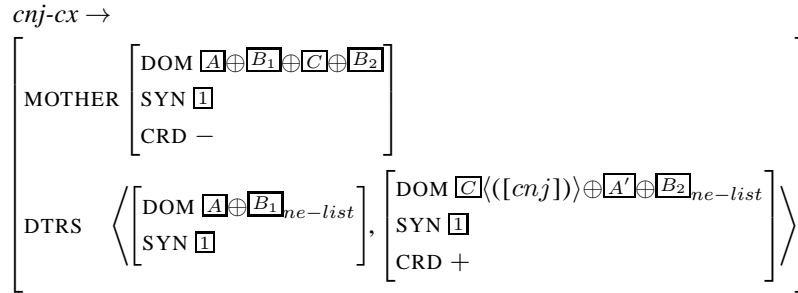

Figure 1: (Simplified) Coordination Construction

Identity restrictions must hold between the two (possibly empty) \boxed{A} and $\boxed{A'}$ lists, although proposals differ about the required identity conditions (cf. §2.1).

So-called long-distance ACC is also consistent with an ellipsis operation:

- (7) Asimov gave a talk about natural selection on Monday, and about general relativity on Thursday.

This is a case of long-distance ACC because the PP[about] is not a complement of the verb. Rather, it is attached to the relational noun *talk*. If this PP were a complement of the verb then one would expect it to be extractable. This prediction is not borne out: **That talk, I think Asimov gave _ about relativity on Thursday*, or **This talk was easy to give _ about relativity on Monday*. Confront with ‘*That talk (about relativity), I think Asimov gave on Thursday*’, and ‘*This talk (about relativity) was easy to give*’. Note that (7) must be interpreted as referring to two different talks, and similarly, that (6d) must be interpreted as involving two different postcards. These facts are also obtained as a prediction of a phonological ellipsis analysis. For example, in one of the readings for (8), a single postcard was addressed to two people, while in the other reading, two distinct postcards were sent.

- (8) I sent a postcard to your brother and to your sister.

The first reading can be obtained with a standard PP coordination parse, while the second can be obtained by a VP coordination parse with elision of the non-initial verb: ‘[*sent a postcard to your brother*] and [~~*sent a postcard*~~ *to your sister*]’ (see Crysmann (2003) and Beavers and Sag (2004) for more discussion).

As Crysmann (2003) and Beavers and Sag (2004) note, a construction like the one in Figure 1 is able to capture ACC phenomena as well as the Coordination of Unlikes data in (1). In this unifying analysis, both phenomena boil down to constituent coordination in which the left periphery of non-initial conjuncts is elided (e.g. [[*is a Republican*] and [~~*is proud of it*~~]]_{VP}).

There are alternative analysis of ACC within HPSG which do not resort to ellipsis. In §2.1 we briefly discuss these accounts and point out some of the problems.

2.1 On the shortcomings of base-generation

In a base-generation analysis of ACC and Coordination of Unlikes, the two phenomena are unrelated and require different mechanisms specifically introduced for that purpose. To our knowledge the first such account in HPSG was put forth in Cho (1996), and more recently a similar proposal is put forth in Mouret (2006). In a nutshell, HPSG's constituency features are redesigned so that ACC (and in the case of Cho (1996), other non-constituent coordination phenomena as well) are base-generated. The coordination schema is allowed to form non-standard constituents, which the verb can take as arguments as informally depicted below:

- (9) John gave [[a book to Mary] [and [a record to Sue]]].

Here, the string '*a book to Mary*' yields a special kind of non-headed cluster constituent which may now be conjoined with other constituents. Cho (1996) thus revises the Subcategorization Principle so that Wasow's Generalization is enforced in ACC: each element in the cluster is required to be compatible with the subcategorization frame of the head. If this constraint is not ensured, then one would obtain cases like **Tom gave a bike to Mia and a book Mary*, and **Tom became tired and in Italy*. At this point we encounter an empirical problem. Similarly to what occurs in Gapping, ACC does not require that the missing verb is phonetically identical to the overt verb. Consider English and German inverted clauses:

- (10) a. Was the message easy to find, and the instructions easy to follow?
 b. *Was the instructions easy to follow?
 c. *Were the message easy to find, and the instructions easy to follow?
 d. *Was the instructions easy to follow, and the message easy to find?
- (11) Ist die Ente im Ofen und ~~sind~~ die Flaschen im Kühlschrank?
 'is the duck in oven and are the bottles in fridge'

On the surface, the result is that the realized verbal head agrees only with the closest NP. The problem for a base-generation analysis arises because '*was*' must select a singular NP argument, and yet it would have to somehow require that the initial conjoined cluster contains such an NP:

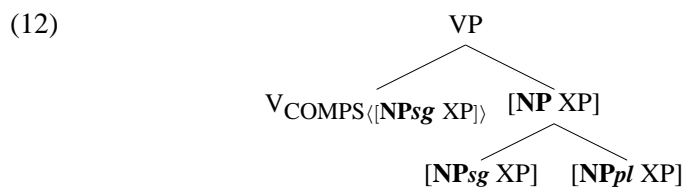

Base-generated ACC is therefore hard-pressed to account for (10a) while at the same time reject (10b–d). On the other hand, no fundamental complications arise in an ellipsis analysis of (10a). The string '*were*' is simply omitted from the second conjunct. More examples are provided in (13).

- (13) a. On the ground floor there is a marble block since early June, and three wooden pillars since late September.

- b. There were many available parking spaces when Tom first called me, but just one handicap space when he arrived.
- c. Why is the TV on full volume, and all the doors left wide open?

In the remainder of this paper we will focus on coordination of unlikes, but see Chaves and Sag (2006) for an ellipsis account of these and other ACC phenomena.

Mouret (2006) also argues that patterns like (14) are problematic for ellipsis. The claim is that the agreement pattern is incompatible with an ellipsis analysis, and that the sentence involves a ‘single complex event’. We do not agree with the latter assessment, on lack of empirical grounds. The observable facts are that the sentence involves two events/situations (one in which a doe comes from a bush and another event in which a fox comes from a field), and the presence of the adverb ‘*simultaneously*’ – in this particular case – asserts that these overlap in time.

- (14) Alors surgissent simultanément d’un buisson une biche, et d’un
 then come simultaneously from-a bush a doe and from-a
 champ un renard.
 field a fox

The existence of two propositions is correctly predicted by an ellipsis account, whereas it has to be stipulated in base-generation via copying-out of the semantic content of predicates. For instance, in (7) one would have to copy-out the verb predicate as well as the NP *a talk*, and ensure that variable binding is done properly. It is not clear exactly how this copying out should work, given that the order of conjoined clusters need not be parallel, as observed in (6b,c).

This brings us to the matter of the semantic analysis of argument clusters, which necessarily requires extending the formalism with very complex machinery specifically designed for this purpose. Cho (1996, 55) argues that HPSG should be extended with a something like a lambda calculus backbone, but this idea is not made precise. Mixing the two formalisms, HPSG’s and lambda calculus, is theoretically undesirable because lambda calculus is already sufficiently expressive to encode entire HPSG grammars (see Copestake et al. (2001) for further arguments against the use of lambda terms in HPSG grammars). Again, an ellipsis approach offers a more parsimonious account since the construction of semantic representations can, for a large part, be done as usual: variable binding is stated lexically, and the semantics of a mother node is defined as the concatenation of the semantic contribution of the local daughters, as for instance in Copestake et al. (2006).

However, the agreement pattern in (14) raises several questions. Most of the speakers we consulted from other Romance languages like Italian, Portuguese, and Spanish, consider examples like (14) to be degraded, although fully comprehensible. A minority of speakers did find it acceptable. Examples in which the adverb is not present are generally harder to process. Cf. the following Portuguese example:

- (15) Entrou / ?*entraram um homem no carro, e uma mulher no taxi.
 entered_{sg} entered_{pl} a man in-the car and a woman in-the taxi

Moreover, our Italian and Portuguese informants also generally agree that the examples below – with number and gender agreement mismatches – are grammatical.

Italian:

- (16) Sono arrivate due amiche venerdì ed
 are arrived_{pl fem} two_{pl fem} friends_{pl fem} Friday and
~~è arrivato~~ un amico lunedì.
 is arrived_{sg masc} one_{sg masc} friend_{pl masc} Monday.
 ‘Two female friends arrived Friday, and one male friend arrived Monday’

Portuguese:

- (17) Chegou um pacote na terça-feira e ~~chegaram~~ duas cartas na sexta.
 arrived_{sg} one package on Tuesday and arrived_{pl} two letters on Friday
 ‘One package arrived on Tuesday and two letters arrived Friday’
- (18) Foram encontradas duas das raparigas ontem à tarde
 were found_{pl fem} two_{pl fem} of-the_{pl fem} girls yesterday in afternoon
 e ~~foi encontrado~~ um dos rapazes hoje de manhã.
 and was found_{sg masc} one_{sg masc} of-the_{pl masc} boys today in morning.
 ‘Two of the girls were found yesterday in the afternoon, and one of the boys was found this morning’

It is implausible that (16) and (18) result from a single verb agreeing with both NPs because the expected agreement would be *plural masc* rather than *plural fem* (regardless of the presence of an adverb like ‘*simultaneously*’):

- (19) Foram editados / *editadas uma brochura e um livro.
 were edited_{pl mas} / edited_{pl fem} a_{fem} brochure_{fem} and a_{mas} book_{mas}

The data in (16) – (18) are similar to (10a), and likewise follow from an ellipsis account. In our view, agreement mismatches like (14) are best explained as cases of ACC which are subject to processing interference, reinforced by the presence of the adverb ‘*simultanément*’ (cf. Beavers and Sag (2004, 63–65)). There is a lot more to say about this kind of effects in more experimental research, in particular, in understanding better the differences and similarities in agreement processing strategies that French and other Romance languages exhibit in these constructions.

Neither Cho (1996) nor Mouret (2006) can account for instances of ACC of unlike categories, as seen in (6b,c). In the case of Cho (1996, 26), this is due to the proposed Subcategorization Principle, which explicitly rules out these cases. This can in principle be corrected at the cost of introducing extra ad-hoc machinery in the account. Despite claims of the contrary, Mouret (2006) cannot account for cases like (6b,c) either. For example, in Mouret (2006) coordination is able to conjoin two non-standard constituents [NP_{sg} NP_{sg}] and [NP_{pl} PP[to]] as in (6c).

It is assumed that the ‘ \leq ’ constraint somehow operates recursively between conjuncts, and as a result, that it underspecifies the conflicting features of the parallel categories. Thus the result of the constraints ‘ $\boxed{0} \leq [\text{NP}_{sg} \text{NP}_{sg}]$, $\boxed{0} \leq [\text{NP}_{pl} \text{PP}[\text{to}]]$ ’ introduced by the coordination rule is a constituent with underspecified head information: $\boxed{0}[\text{NP XP}]$. On the other hand, a verb like ‘give’ requires NP and PP[to] complements. This fact is encoded in the lexical entry by specifying, for instance, $[\text{COMPS} \langle \text{NP}, \text{PP}[\text{to}] \rangle]$.

Here is where the proposal breaks down. There seems to be no way to state the subcategorization constraints of the verb such so that it is compatible with both $[\text{NP}_{sg} \text{NP}_{sg}]$, $[\text{NP}_{pl} \text{PP}[\text{to}]]$, or $[\text{PP}[\text{to}] \text{NP}_{sg}]$ clusters, without overgeneration. This is because of the above ‘ \leq ’ bounding constraints, introduced over $\boxed{0}[\text{NP XP}]$. No description *more specific* than $[\text{NP XP}]$ can unify with this cluster. This is illustrated in Figure 2: $\boxed{1}$ cannot unify with $\boxed{0}$ because $\text{PP}[\text{to}] \not\leq \text{NP}_{sg}$.

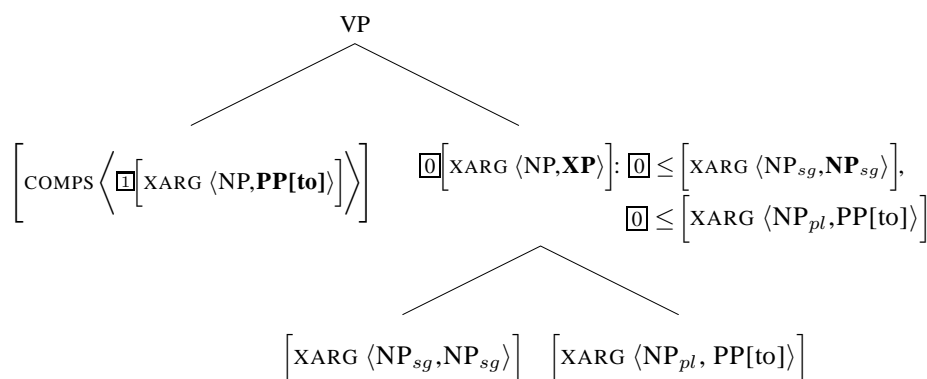

Figure 2: VP ‘gave [Mary a coloring book, and new roller skates to her sister]’

This problem still arises if the verb subcategorizes for $[\text{COMPS} \langle \text{PP}[\text{to}], \text{NP} \rangle]$ or $[\text{COMPS} \langle \text{NP}, \text{NP}[\text{to}] \rangle]$ instead. More generally, this issue is raised for any other verb that allows alternations with complements of different categories. Using underspecification on either or both arguments will allow overgeneration (e.g. ‘*I gave [Mary a book and a bike Tom]_[NP NP]’). Note that the problem is created by argument cluster formation and not by the ‘ \leq ’ constraint: Sag (2002) correctly rules out cases like *Tom grew happy and a Republican by resorting to this very technique, as discussed in §2. The verb ‘grew’ specifies for $[\text{COMPS} \langle \text{AP} \rangle]$, but the type $\boxed{0}$ nominal of the complement ‘happy and a Republican’ cannot unify with the type *adj* in the complements list because of the constraint $\boxed{0} \leq \textit{noun}$.

There are other problems raised by base-generated ACC. For instance, nothing is said in these accounts about Binding Theory. With argument clusters, the members of the verbal ARG-ST no longer directly correspond to the subcategorized arguments. For instance, a verb may subcategorize for a complement cluster like $[\text{NP NP}]$, which can be composed of two conjuncts $[[\text{NP NP}] [\textit{conj} [\text{NP NP}]]]$. The latter can exhibit very distinct binding relations, and thus one can no longer state binding principles over ARG-ST members.

It is important to point out that neither base-generation approaches nor ellipsis approaches are free of multiple analysis. However, the argument is that all things being equal, there is a preference for constituent coordination over ellipsis. Particularly, if ellipsis is seen as a simplification strategy adopted by speakers. Thus, in certain contexts and with certain constructions, multiple solutions capture actual ambiguities as in (8). That is, as long as the underlying coordination structure is well-formed. The sentence in (20a), for instance, is felicitously interpreted as S coordination, in which case different letters were discovered. The case is similar in (20b), taken from Beavers and Sag (2004).

- (20) a. Several letters were discovered by me in 1982, and by my wife in 1993.
 b. Three men died in Baghdad on Tuesday, and in Tikrit on Friday night.

The full range of elliptical analysis may therefore be grammatically available, but restricted by contextual, processing, and discourse-based strategies.

In sum, the existing base-generation accounts of ACC and Coordination of Unlikes raise more problems than the ones they claim to solve. Ellipsis provides a more promising and parsimonious research avenue for these phenomena.

3 Unlike dangling modifiers

Most of the focus on coordination of unlikes phenomena has been on arguments. There are however some problematic cases concerning certain S-adjointing phrases. Consider the sentences given in (21):

- (21) a. Wealthy and a Republican, Fred quickly rose in the political arena.
 b. Alone and without money, John found himself unable to get a job.
 c. A successful business woman and in the position to take charge of her life, Madam C. J. Walker went on to become a millionaire.
 d. A woman, rich, and in the lucky position of owing a castle, Zoe did not let such an opportunity slip through her fingers.
 e. Hungry and feeling rotten to the core, the soldiers packed their gear and broke camp before dawn.
 f. Descended from Mexicans, and being an impressionable young man, I naturally settled into the traditional beer with a twist of Tabasco sauce.

The adjunct is prosodically independent, and typically, each unlike conjunct is also prosodically contrasted. Ellipsis can in principle account for the data in (21) by eliding the right-periphery, e.g. [AP \mathfrak{S}]_S & [NP & S]_S. However, there are cases which cannot be reduced to S coordination. This is either because the underlying conjuncts are either ungrammatical. or because the S coordination counterpart has different truth-conditions. In the examples below, the structure [[[cnj Adj] [cnj PP]] S] cannot be reduced to [[cnj [Adj \mathfrak{S}]] [cnj [PP S]]]:

- (22) a. Neither tired nor in a hurry, I decided to walk and save the bus fare.

- b. Both tired and in a foul mood, Bob packed his gear and headed North.
- (23) a. *Neither tired, I decided to walk and save the bus fare nor in a hurry, I decided to walk and save the bus fare.
- b. *Both tired, Bob packed his gear and headed North, and in a foul mood, Bob packed his gear and headed North.

Here the problem stems from syntax. The correlative coordinators ‘[*both ... and ...*]’ and ‘[*neither ... nor ...*]’ cannot be clause initial (Sag et al., 1985, pp. 138, ft. 12). The cases in (24) on the other hand, are problematic on truth-conditional grounds, because the adverb is interpreted as modifying the unlike conjuncts, not the clause:

- (24) a. Simultaneously [shocked and in awe], Fred couldn’t believe his eyes.
- b. Probably [injured and on the verge of exhaustion], one of the deer was unable to squeeze through the iron fence.

The remainder of this paper proceeds as follows. We will consider in more detail the properties of this kind of construction, setting aside coordination for a moment. In the end, by virtue of our account of dangling modifiers, the above coordination data fall out as a consequence, without further stipulations.

4 An analysis

Dangling modifiers are always composed of predicative phrases, and these usually receive a subject-oriented interpretation:

- (25) a. *Exhausted, the river started pulling John away from the margin.
- b. *Pregnant with twins, Tom helped Mary into the delivery room.
- c. *An 1949 Oldsmobile, Mary painted her car.

The ‘topic’ position of the adjunct cannot be attributed to extraction of an embedded modifier for several reasons. The *in situ* realizations can be either ungrammatical or truth-conditionally different (often a *causal / justification* import is attributed to the S-adjointing phrase):

- (26) Tired, Tom decided to go home. \neq Tom decided to go home tired.
- (27) a. A trained nurse, she was to become vice-president of the Royal College.
- b. *She was to become vice-president of the Royal College a trained nurse.

Moreover, the relevant target seems to be the semantic subject. In the inverted clause below, the dangling modifier phrase preferentially targets the NP ‘*the roofless ruins of a stone house*’, rather than the structurally closer NP ‘*the river*’.

- (28) a. Silent and gray in the moonlit evening, a few yards away beyond the river stood the roofless ruins of a stone house.
- b. # Too fast for them to navigate, a few yards away beyond the river stood the roofless ruins of a stone house.

Still, the targeted NP can be embedded if the subject of the matrix clause is a non-referential pronoun, as seen in (29).

- (29) a. Bored out of his mind, it seemed to John that an entire week had gone by.
 b. Exhausted from the heavy load, it never occurred to Bob that he should have camped while there was some light left.

Another property of these adjuncts is that individual-level predicates (i.e. denoting intrinsic, non-transient properties) exhibit a tendency to avoid this position:

- (30) a. Exhausted, he decided to sit down under a tree.
 b. Furious, Tom left the room and returned to the hotel.
 c. Sick with the flu, Ann was out of school for two weeks.
- (31) a. *Spanish, Maria was already familiarized with some of the dancing steps.
 b. *Homosexual, Fred was not enlisted in the Marines.
 c. *Blonde, Mia had to dye her hair black for the role.
 d. *Vegetarian, Ann always cooked dishes that we hated.

If the individual level predicate is embedded in a copula participle structure, then the oddness vanishes as illustrated in (32).¹

- (32) a. Being Spanish, Maria was already familiarized with the dancing steps.
 b. Being homosexual, Fred was not enlisted in the Marines.

There are cross-linguistic idiosyncrasies regarding individual-level and stage-level predicates, but the distinction is widespread. For instance, in Spanish, Portuguese, Italian, and Old French the copula verb *stare* (Latin for ‘to stand’) is only compatible with stage level adjectives, while the copula *esse* (Latin for ‘essence’) is only compatible with individual level adjectives. Accordingly, only the former usually occur with a null copula, as illustrated in (33) from Portuguese:

- (33) a. (Estando) cansada, a Ana voltou para a cama.
 (Being_{stare}) tired the Ana returned to the bed.
 ‘Feeling tired, Ana went back to bed’
- b. *(Sendo) europeia, a Ana pode regressar para casa
 Being_{esse} European the Ana could return to home.
 ‘Being European, Ana could return home’

Note that although the presence of the *esse* copula is, in these constructions, obligatory with individual level adjectives, it is optional in the case of predicative NP complements. However, predicative NPs are usually also compatible with *stare*.

Superlative forms are known to allow individual level predicates to become stage-level. As expected, these elements can occur in the dangling construction:

- (34) Blonder than ever, the 49-year-old performer made a stunning stage entrance.

¹The copula does make some form of semantic/aspectual contribution. For instance, two copulas can co-occur with semantic contrast: ‘*Kim is shy*’ \nleftrightarrow ‘*Kim is being shy*’ and ‘*Kim is a fool*’ \nleftrightarrow ‘*Kim is being a fool*’. The main verb is interpreted as stage level while the nested verb is interpreted as individual level (= ‘*NP acts as if intrinsically XP*’). Conversely, two copulas cannot co-occur in the case of stage level complements, because the interpretation ‘*NP is intrinsically acting as if XP*’ is nonsensical: ‘*Kim is (*being) tired*’ and ‘*Kim is (*being) in a good mood*’.

All this evidence suggests that the adjuncts in (30) may involve a null copula. In fact, some informants spontaneously reported perceiving a copula verb in these data to the likeness of the examples in (32).²

Note that the same optional copula pattern arises in absolute constructions:

- (35) a. (With) Tom (being) too drunk to drive, I called my parents to pick us up.
b. (With) Sue (being) injured, we were unable to carry on the play.
c. (With) the truck (being) finally loaded, they said goodbye and drove off.
- (36) a. With Tom *(being) racist, we were unable to participate in the play.
b. With trade *(being) domestic, we end up being dragged into domestic Mardukan politics (...)
c. With my friends *(being) European, we could travel without any Visas.
d. With Mother Nature *(being) kind, I am proud to say I managed my natural features without any surgeries.

Similarly, predicative NPs and PPs can also occur without the copula:

- (37) a. With Tom out of town, Beth hastily exited New Albany and fled to Ohio.
b. With Bush a born-again Christian, the public already had a sense of where he would stand on those issues.

In the HPSG analysis of absolutes in Riehemann and Bender (1999), it is made the standard assumption that these structures consist of a lexical item '*with*' followed by a small clause of the form '[NP + predicative XP]'. To account for the optional preposition two phrasal constructions are put forth: one to obtain a S-adjoining PP and a second construction for obtaining S-adjoining *with*-less PPs from a predicative small clause.

However, we believe that the elements after the preposition are better viewed as forming a gerund phrase rather than a small clause. One of the trademarks of gerunds is the possibility of having a subject in accusative or genitive case:

- (38) a. With [us (being) located in Dublin], we can collect all candidate applications into one location.
b. With [him (being) injured], the team was eliminated from both Europe and the State Cup.
c. With [your handling and Mogs'], I'm quickly beginning to see the benefits of the final color change, rather than the finish I've used.
d. With [Sandy's (being) stoned all the time], we'll never get a record deal.

²There are other well-known cases first noted in Bolinger (1967) which may also involve copulas. Here, stage level adjectives can be realized post-nominally in English (e.g. '*All rivers navigable are being controlled*', and '*Every penny available was put into the project*'). The main differences are that the missing copula would have to be in finite form, and that predicative NPs are disallowed: '*A man *(who is) a Republican is also a God-fearing person*'. Nothing prevents our account from allowing empty finite copula VPs to occur as reduced relative clause constructions.

In our view, some of the phenomena discussed in Riehemann and Bender (1999) involving idioms in absolutes require a different explanation.³

The remainder of this paper provides an account of optional copulas in these two constructions, and so doing, also captures the Coordination of Unlikes data.

4.1 A phrasal construction account

The fact that certain participle VPs attach to clauses, and that the copula is optional in some cases is captured by the interplay of two distinct non-branching constructions. The construction in (39a) allows participle VPs to be *coerced* into subject-oriented clause adjoining constructions (henceforth referred to as ‘Vp’). The construction in (39b) allows certain predicative XPs to be *coerced* into VPs.

(39) a. *dangling-prp-cx* →

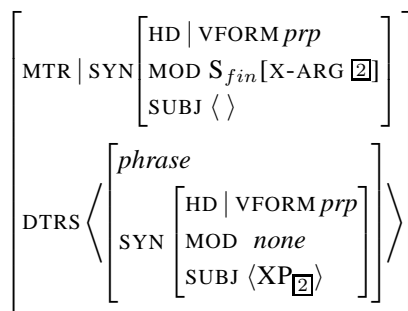

b. *silent-copula-cx* →

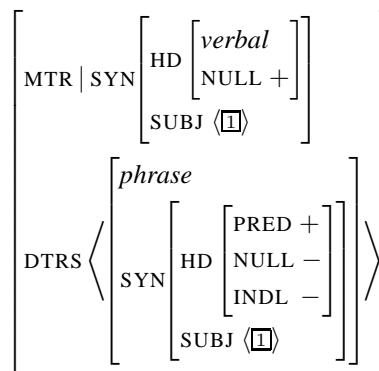

The construction in (39a) allows a present participle (*prp*) VP to become a Vp. The latter adjoins to S, does not require a subject argument, and has the subject referent bound to the subject of S. Following Sag and Pollard (1991) and others, the feature X-ARG is used to single out the subject referent of the matrix clause, and assume that a Vp adjoins to a matrix clause via a standard *head-modifier* construction.

The construction in (39b), on the other hand, obtains silent (present-participle or gerund) copula VPs from predicative stage-level XPs. If the category of the mother node in (39b) is resolved as a participle, then it can feed the construction in (39a) to obtain silent copula dangling participles. This allows the grammar to capture cases like ‘*Trying to be polite, Peter asked if he should leave*’ and ‘*(Being) an expert on blepharoplasty, Sue grasped the problem right away*’.⁴

³Basically, certain idioms only occur in *with* absolutes, and not in *with-less* absolutes, e.g. **Peace talks old hat, it’s hard to get a sense of the situation*. We conjecture that oddness arises from processing interference caused by the lack of clues as to what is the constituency relation one should attribute to a sequence of NPs. The data improve once more information is present, e.g. if the copula is realized *Peace talks being old hat, it’s hard to get a sense of the situation*, or if the preposition is realized, thus making clearer which construction is at stake. This is also consistent with the considerable degree of judgment variation which Riehemann and Bender (1999) encounter for these cases.

⁴In regard to cases like (29) above, we assume without further discussion constraint requiring that the value of X-ARG of verbs with an expletive *it* subject is structure-shared with the value of X-ARG of the S complement. Future work must be dedicated to a more detailed discussion about this matter.

If the category of the mother in (39b) is resolved as a gerund, then it may be taken as a nominal complement of ‘with’. This is made possible by following Malouf (2000) in assuming that gerunds are a mixed category that belongs to both verbal and nominal parts-of-speech:

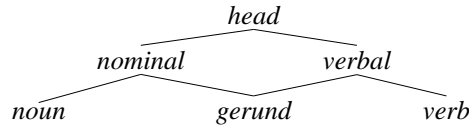

Figure 3: Gerunds as mixed categories in the part-of-speech type hierarchy

The feature [VFORM *vform*] is assumed to be appropriate for the type *verbal*. Accordingly, *gerund* only allows for the specification [VFORM *ger*].

Note that two new features are introduced in (39b). The feature [NULL *bool*] is adopted in order to prevent the silent copula from occurring freely in other constructions. A second feature, [INDL *bool*], identifies individual/stage level predicates. Adjectives like ‘*calm*’ or ‘*sick*’ can occur with both kinds of copulas and therefore remain underspecified for INDL. This is also the case for nouns, since they are generally compatible with both *stare* and *esse* copulas. Prepositions usually pattern with *stare* copulas and thus will be specified as [INDL–].

The gerund resolution of (39b) yields a constituent which is a suitable complement for a preposition. All we need to capture the two kinds of absolute constructions under discussion are two other grammar constructions:

$$(40) \text{ a. } \textit{with-less-absol-cx} \rightarrow \left[\text{MTR} \left[\text{SYN} \left[\begin{array}{l} \text{HEAD } \textit{prep} \\ \text{MOD } S_{fin} \\ \text{SUBJ } \langle \rangle \\ \text{COMPS } \langle \rangle \end{array} \right] \right] \right] \left[\text{DTRS} \left\langle \left[\text{SYN} \left[\begin{array}{l} \text{HD } \textit{gerund} \\ \text{SUBJ } \langle \rangle \\ \text{COMPS } \langle \rangle \end{array} \right] \right] \right\rangle \right]$$

$$\text{ b. } \textit{with-absol-cx} \rightarrow \left[\text{MTR} \left[\text{SYN} \left[\begin{array}{l} \text{HEAD } \textit{prep} \\ \text{MOD } S_{fin} \\ \text{SUBJ } \langle \rangle \\ \text{COMPS } \langle \rangle \end{array} \right] \right] \right] \left[\text{DTRS} \left\langle \left[\textit{with} \right], \left[\text{SYN} \left[\begin{array}{l} \text{HD } \textit{gerund} \\ \text{SUBJ } \langle \rangle \\ \text{COMPS } \langle \rangle \end{array} \right] \right] \right\rangle \right]$$

The construction in (40a) accounts for *with-less* absolutes, and (40b) (adapted from Bender (2002)) is responsible for *with* absolutes. Of course, absolutes phrases with silent copulas are possible because the construction in (39b) is able to produce ‘[NULL+]’ gerunds. To account for the causative interpretation that usually arises in both dangling participle and absolute constructions, we can simply introduce a supertype construction over *dangling-prp-cx*, *with-less-absol-cx*, and *with-absol-cx* which introduces this kind of semantic import (see section §4.2 for instance).

Notice that nothing prevents silent copula Vps from being conjoined. This means that a standard coordination rule is able to obtain the (apparent) cases of Coordination of Unlikes in (21) and (22) for free, as constituent coordination:

(41) [[Neither Vp] [nor Vp]]_{VP} [I decided to walk and save the bus fare]_S

The analysis of a mixed case of [AP & VP] is illustrated in more detail in (42):

(42) More optimistic and beginning to understand the problem, we decided to reorganize the code into something more logical and manageable.

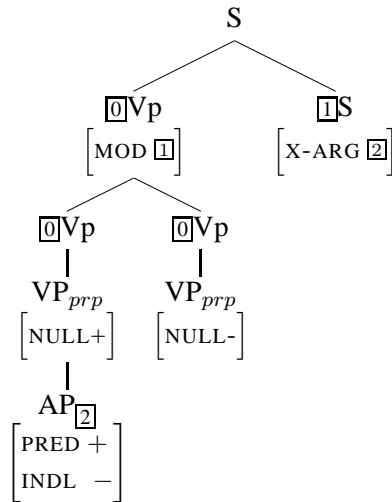

The *VP-to-Vp* construction in (39a) is underspecified in regard to NULL, given that dangling participles make no commitment about the phonetic realization of the copula. Nothing else needs to be added about coordination of unlikes in dangling modifiers. These cases all follow from the account just proposed.

But a problem arises when scaling this fragment to other related constructions: for each new case one must introduce several more pairs of construction types. For instance, two more construction types are needed for temporal absolutes. These are headed by an adverb and their arguments are participles:

- (43) a. (When) opening the front door, the clock struck midnight.
 b. *When Tom (being) tired, we went back home.

Stump (1985, 330f.) notes other absolutes headed by different words, such as:

- (44) Crossing the street, {
 John was hit by a car. ('while')
 John entered the bank. ('after')
 John entered a different country. ('by')

In order to account for the syntactic (and semantic) properties of these absolutes the grammar ends up enumerating a series of phrasal constructions (plus one lexical for obtaining 'NULL-' gerunds, such as Malouf (2000, 66)). Below we explore an alternative account which resorts to *lexical* constructions. The Coordination of Unlikes phenomena are obtained as a prediction in a similar way, but more cross-cutting generalizations are possible, so that the same results are obtained in a more systematic way. In fact, our results are similar to the findings in Müller (2004), in which a phrasal account of certain German word order phenomena is argued to

miss basic regularities that an empty copula analysis captures straightforwardly.

4.2 A lexical construction account

The usage of empty categories in HPSG is not without controversy. Some recent proposals which resort to such elements for various purposes are Netter (1998), Meurers (2000), Bender (2002), Borsley (2004), and Müller (2004) among others. As Riehemann and Bender (1999) note “In general, there is a certain formal equivalence between null elements and constructions. (...) However, approaches based on null elements and those based on constructions do differ in the kinds of generalizations they can capture elegantly”.

A lexical account of optional heads in dangling and absolute constructions boils down to 3 core (post-inflectional) lexical constructions. A *dangling-participle* construction accounts for dangling participles in general, an *absolute* construction for absolutes in general, and a *null-copula* construction for obtaining silent copulas. In other words, the fragment scales straightforwardly without the need for extra kinds of constructions, unlike the phrasal analysis. We still adopt the part-of-speech hierarchy given in Figure 3 §4.1, as well as the account of gerundive constructions proposed in Malouf (2000). Consider the hierarchy given below in Figure 4.

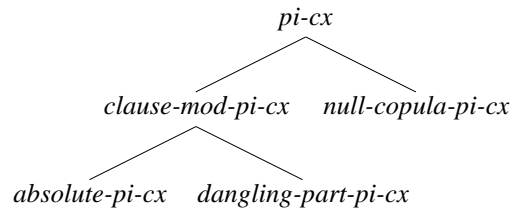
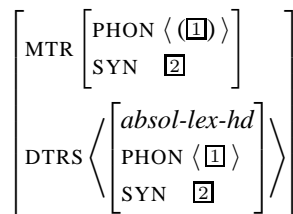

Figure 4: Post-inflectional Lexical Construction Hierarchy

Only lexical items of type *absol(ute)-lex(ical)-h(ea)d* are suitable daughters for the absolute lexical construction in (45a). More specifically, *absol-lex-hd* is a supertype of a prepositional marker ‘with’ (which lexically selects for [VFORM *ger*] phrases), as well as of ‘when/while’ (selecting [VFORM *prp*] phrases), and so on (these and other idiosyncrasies can also be captured with a multi-inheritance hierarchy). According to (45a), the head of an absolute is optionally realized:

(45) a. *absolute-pi-cx* →



b. *dangling-part-pi-cx* →

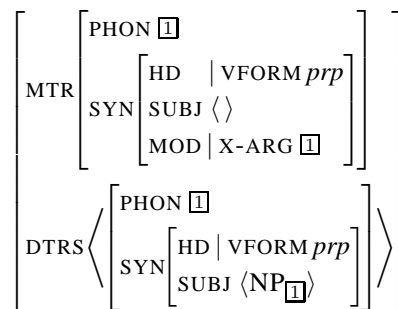

c. *null-copula-pi-cx* →

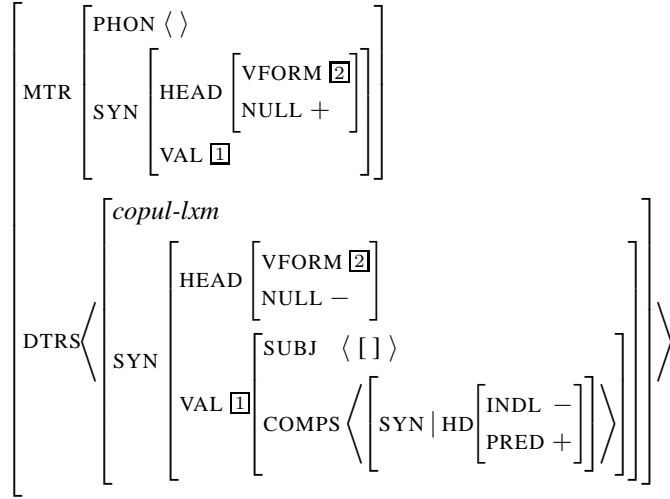

It is left to the null copula rule in (45c) to yield silent (i.e. [NULL+]) participle/gerunds heads (subcategorizing for stage-level predicative complements) which can in turn either feed into the absolute or the participle constructions. Accordingly, the participle construction in (45b) applies regardless of the value of NULL.

Even though dangling participles and absolutes are very different constructions, they also share many properties which can be systematically captured by a more general construction type in the hierarchy:

(46) *clause-mod-pi-cx* →

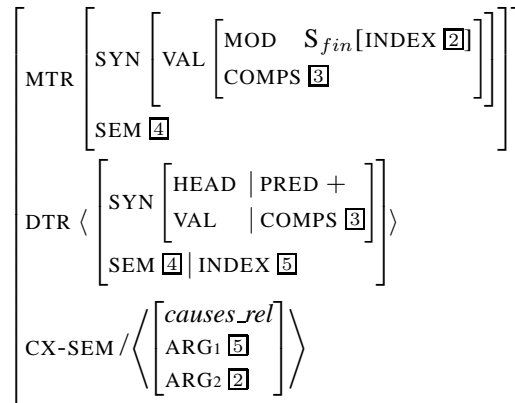

Basically, both dangling participle and absolute constructions yield lexical heads with the ability to project subjectless S-adjoining phrases, without changes to the COMPS subcategorization frame, and receive a default causal reading in relation to the matrix clause. Although this account differs only in small ways from the phrasal account, we end up with a much more general and parsimonious analysis, consisting of a general construction type per S-adjoining construction.

Moreover, the coordination phenomena are also obtained as Vp constituent coordination. Consider the tree depicted in Figure 5, for the example (42) above.

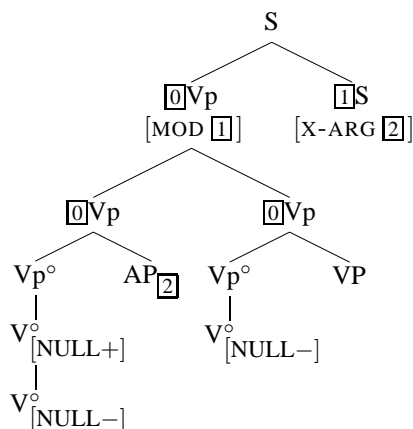

Figure 5: Tree for (apparent) unlike dangling modifier phrases: [[AP & VP] S]

The coordination of unlikes phenomena in dangling phrases are thus a consequence of an independent analysis of optional copulas in S-adjoining constructions.

4.2.1 A brief note about linearization

The usual assumption in domain-based HPSG linearization theories is that adjunct phrases are fully compacted, and allowed to interleave with the structures they adjoin to. Moreover, non-embedded clauses are only partially compacted (e.g. Kathol (2000)). By adopting this linearization constraints, the present account obtains several orderings for both dangling participle and absolute constructions. As expected, the possible modifier phrase realizations are semantically and prosodically similar.

- (47) a. [Alone and without money], [John] [returned] [to his family in Alabama].
 b. [John], [alone and without money], [returned] [to his family in Alabama].
 c. [John] [returned], [alone and without money], [to his family in Alabama].
 d. [John] [returned] [to his family in Alabama], [alone and without money].
- (48) a. [With him badly injured], [the team] [was] [eliminated from the cup].
 b. [The team], [with him badly injured], [was] [eliminated from the cup].
 c. [The team] [was], [with him badly injured], [eliminated from the cup].
 d. [The team] [was] [eliminated from the cup], [with him badly injured].

5 Conclusion

This paper proposes a unified analysis of both dangling participle constructions and absolute constructions. As a consequence of our account, problematic ‘coordination of unlikes’ phenomena that occur in these structures are obtained without further assumptions. A constructional analysis is put forth, and two variants are compared: a lexical and a phrasal approach. Aesthetic and computational considerations aside, the lexical account emerges as the more parsimonious given that it allows for a more systematic treatment requiring fewer theoretical constructs.

References

- Beavers, John and Sag, Ivan A. 2004. Ellipsis and Apparent Non-Constituent Coordination. In Stefan Müller (ed.), *Proceedings of the 11th International Conference on Head-Driven Phrase Structure Grammar, Katholieke Universiteit Leuven*, pages 48–69, Stanford: CSLI Publications.
<http://cslipublications.stanford.edu/HPSG/5/>
- Bender, Emily M. 2002. *Syntactic Variation and Linguistic Competence: The Case of AAVE Copula Absence*. Phd thesis, Stanford University.
- Bolinger, Dwight. 1967. Adjectives in English: Attribution and predication. *Lingua* 18, 1–34.
- Borsley, Robert D. 2004. An Approach to English Comparative Correlatives. In Stefan Müller (ed.), *Proceedings of the HPSG-2004 Conference, Center for Computational Linguistics, Katholieke Universiteit Leuven*, pages 70–92, Stanford: CSLI Publications.
<http://cslipublications.stanford.edu/HPSG/5/>
- Chaves, Rui and Sag, Ivan A. 2006. Two kinds of ellipsis in English coordinate structures, unpublished manuscript, pp. 31, Stanford University.
- Cho, Sae-Youn. 1996. *Non-Constituent Coordination as a Subtype of Constituent Coordination*. PhD Thesis, Graduate College of the University of Illinois, Urbana-Champaign.
- Copestake, Ann, Flickinger, Daniel, Sag, Ivan and Pollard, Carl. 2006. Minimal Recursion Semantics: An Introduction. *Journal Research on Language & Computation* 3(4), 281–332.
- Copestake, Ann, Lascarides, Alex and Flickinger, Dan. 2001. An Algebra for Semantic Construction in Constraint-based Grammars. In *Proceedings of the 39th ACL*, Toulouse, France.
- Crysmann, Berthold. 2003. An Asymmetric Theory of Peripheral Sharing in HPSG. In Gerhard Jäger, Paola Monachesi, Gerald Penn and Shuly Wintner (eds.), *Proceedings of Formal Grammar 2003*, pages 47–62, ESSLLI 2003, Vienna, Austria.
- Daniels, Michael W. 2002. On a Type-Based Analysis of Feature Neutrality and the Coordination of Unlikes. In Frank Van Eynde, Lars Hellan and Dorothee Beermann (eds.), *8th International Conference on Head-Driven Phrase Structure Grammar*, pages 137–147, Stanford: CSLI Publications.
<http://cslipublications.stanford.edu/HPSG/2/>
- Jacobson, Pauline. 1987. Review of Gerald Gazdar, Ewan Klein, Geoffrey K. Pullum, and Ivan Sag, 1985: *Generalized Phrase Structure Grammar*. *Linguistics and Philosophy* 10, 389–426.
- Kathol, Andreas. 2000. *Linear Syntax*. Oxford University Press.
- Levy, Roger and Pollard, Carl. 2002. Coordination and Neutralization in HPSG. In Frank Van Eynde, Lars Hellan and Dorothee Beermann (eds.), *The Proceedings of the HPSG-2002 Conference*, pages 221–234, Stanford: CSLI Publications.
<http://cslipublications.stanford.edu/HPSG/2/>

- Malouf, Robert. 2000. *Mixed Categories in the Hierarchical Lexicon*. Stanford: CSLI Publications.
- Meurers, Walt Detmar. 2000. Lexical Generalizations in the Syntax of German Non-Finite Constructions. Arbeitspapiere des SFB 340 No. 145, Eberhard-Karls-Universität, Tübingen.
- Mouret, Francois. 2006. A phrase structure approach to argument cluster coordination in French. In Kiril Simov and Petya Osenova (eds.), *Proceedings of the HPSG-2006 Conference, Bulgarian Academy of Sciences, Varna, Bulgaria*, pages 101 – 107, Publishing House ETO, Sofia, <http://www.bultreebank.org/HPSG06/paper16.pdf>
- Müller, Stefan. 2004. Elliptical Constructions, Multiple Frontings, and Surface-Based Syntax. In Gerhard Jäger, Paola Monachesi, Gerald Penn and Shuly Winter (eds.), *Proceedings of Formal Grammar 2004, Nancy*, CSLI Publications.
- Netter, Klaus. 1998. *Functional Categories in an HPSG for German*. Saarbrücken dissertations in computational linguistics and language technology, no. 3, Saarbrücken: Deutsches Forschungszentrum für Künstliche Intelligenz und Universität des Saarlandes.
- Pollard, Carl and Sag, Ivan A. 1994. *Head-driven Phrase Structure Grammar*. Chicago University Press, Chicago.
- Pullum, Geoffrey K. and Zwicky, Arnold M. 1986. Phonological Resolution of Syntactic Feature Conflict. *Language* 72, 751–773.
- Riehemann, Susanne Z. and Bender, Emily. 1999. Absolute Constructions: On the Distribution of Predicative Idioms. In *WCCFL 18 Proceedings*, Somerville, MA: Cascadilla Press.
- Sag, Ivan. 2002. Coordination and Underspecification. In *Proceedings of the 9th International Conference on Head-Driven Phrase Structure Grammar*, Kyung Hee University, Seoul, South Korea, pages 267–291, Stanford, CSLI Publications. <http://cslipublications.stanford.edu/HPSG/3/>
- Sag, Ivan, Gazdar, Gerald, Wasow, Thomas and Weisler, Steven. 1985. Coordination and how to distinguish categories. *Natural Language and Linguistic Theory* 3, 117–171.
- Sag, Ivan A. and Pollard, Carl. 1991. An Integrated Theory of Complement Control. *Language* 67(1), 63–113.
- Stump, Gregory T. 1985. *The Semantic Variability of Absolute Constructions*. Dordrecht: Reidel.
- Yatabe, Shûichi. 2001. The syntax and semantics of left-node raising in Japanese. In Dan Flickinger and Andreas Kathol (eds.), *Proceedings of the 7th International Conference on Head-Driven Phrase Structure Grammar*, pages 325–344, Stanford, CA: CSLI Publications. <http://cslipublications.stanford.edu/HPSG/1/>
- Yatabe, Shûichi. 2004. A Comprehensive Theory of Coordination of Unlikes. In Stefan Müller (ed.), *Proceedings of the HPSG-2004 Conference*, Katholieke Universiteit Leuven, pages 335–355, Stanford, CSLI Publications. <http://cslipublications.stanford.edu/HPSG/5/>