

“Agreement mismatch” between sort/kind/type and the determiner

Takafumi Maekawa

Ryukoku University

Proceedings of the 22nd International Conference on
Head-Driven Phrase Structure Grammar

Nanyang Technological University (NTU), Singapore

Stefan Müller (Editor)

2015

Stanford, CA: CSLI Publications

pages 136–156

Maekawa, Takafumi. 2015. “Agreement mismatch” between sort/kind/type and the determiner. In Stefan Müller (ed.), *Proceedings of the 22nd International Conference on Head-Driven Phrase Structure Grammar, Nanyang Technological University (NTU), Singapore*, 136–156. Stanford, CA: CSLI Publications. DOI: 10.21248/hpsg.2015.9. 

Abstract

A singular countable noun in English normally needs a determiner and they should agree in number. However, there is a type of noun phrase, such as *these sort of skills*, which does not conform to this generalisation. As a singular countable common noun the noun *sort* requires a determiner, but there is an agreement mismatch here: *sort* is singular but the determiner is plural. Rather, the determiner agrees with the NP after the preposition *of*. There are several possible analyses that might be proposed, but the best analysis is the one in which *sort* and the preposition *of* are ‘functors’, non-heads selecting heads.

1 Introduction

A plural countable noun in English can stand on its own, without a determiner (1a).¹ A singular countable noun, however, normally needs a determiner in order to be grammatical. The noun *book* in (1b), which is a singular and countable common noun, requires a determiner to combine with, and the determiner *this* would satisfy this requirement.

- (1) a. books
- b. *(this) book

Moreover, the determiner should agree in number with the head noun, as in (2).

- (2) a. this book
- b. *these book

In (2b) the noun and the determiner do not agree in number. Thus, it might be possible to make a generalisation of the following sort.

- (3) A singular countable noun in English requires a determiner and they should agree in number.

(1b) and (2b) do not conform to this generalisation.

Determiners are often assumed to be a specifier of a head noun in HPSG (Pollard & Sag 1994, Sag et al. 2003, Kim 2004, Kim & Sells 2008). In this

[†]I would like to thank the participants at HPSG 2015, especially Frank Van Eynde and Dan Flickinger, for their feedback and discussions. Thanks are also due to Bob Borsley for his valuable comments on the earlier version of this paper. I am also grateful to four anonymous reviewers for HPSG 2015 and the participants at the presentation given at the meeting of Rokko English Linguistics Circle held on 27th December 2014. Any shortcomings are my responsibility. This research was supported by the Japan Society for the Promotion of Science (Grant-in-Aid for Scientific Research (C) 26370466).

¹Following Huddleston & Pullum (2002:355) we assume that the term ‘determiner’ refers to the following things: determinatives (*the tie*), determiner phrases (*almost every tie*), genitive NPs (*my tie*), plain NPs (*what colour tie*), PPs (*over thirty ties*).

assumption the partial lexical description for a singular countable noun is something like the following (cf. Sag et al. (2003:107), Kim (2004:1114), Kim & Sells (2008:108)).

$$(4) \left[\begin{array}{l} \text{HEAD} \\ \text{SPR} \end{array} \left[\begin{array}{l} \textit{noun} \\ \text{AGR } \boxed{1} \text{ [N } \textit{sg}] \\ \langle \text{ [AGR } \boxed{1}] \rangle \end{array} \right] \right]$$

The value of the HEAD feature includes the AGR (AGREEMENT) feature. The value of the latter represents information about morpho-syntactic properties of the expression. The N (NUMBER) value represents the information about the grammatical number. (4) indicates that this word is morpho-syntactically singular. The SPR (SPECIFIER) feature shows that this expression has a specifier and indicates what kind of specifier it is. Thus, the determiner requirement of a countable singular noun is encoded as a matter of valency. The boxed tag $\boxed{1}$ in (4) means that the specifier has the same AGR value as the head noun, representing determiner-noun agreement. Overall, (4) states that a singular countable noun should have a specifier which agrees with it in number. Thus it can capture the generalisation stated in (3) and account for the unacceptability of (1b) **(this) book* and (2b) **these book*: the former lacks a specifier and the latter does not show specifier-noun agreement.

Note that in (4) the determiner-noun agreement is represented on the basis of the SPR specifications of the head noun. This means that if the head noun is a singular countable noun not only the determiner requirement but also the determiner-noun agreement refers to the SPR specifications of the head noun.

However, there is a type of noun phrase in English which does not conform to this generalisation but is acceptable at least in an informal style.

- (5) a. *these sort of skills*
 b. *those kind of pitch changes*
 c. *these type of races* (Keizer 2007:170)

These noun phrases contain a singular countable noun *sort*, *kind* and *type*, respectively. We will refer to them collectively as 'sort-nouns'. In (5) the *sort-noun* is preceded by the plural determiner and followed by the preposition *of*, which in turn is followed by the plural noun. We will call these constructions in (5) as 'Plural Determiner plus Sort-Noun Construction (PDSNC)'. The *sort-noun* in PDSNCs requires a determiner because it is a singular countable common noun. The only possible determiner that can satisfy this requirement is the one just before it (Hudson 2004:38). It should be noted that there is a sort of agreement mismatch here: the *sort-noun* is singular

but the determiner is plural. Rather, the determiner agrees with the NP after the preposition *of*. It is clear that this is incompatible with the generalisation stated in (3) and described in (4).

The purpose of this paper is to investigate the syntactic properties of *sort*-nouns and PDSNCs, and consider how they might be analysed within the framework of Head-driven Phrase Structure Grammar (HPSG). We will argue that the *sort*-noun and the preposition *of* in PDSNCs are functors, non-heads selecting heads (Van Eynde 2006, Allegranza 1998).

The organisation of this paper is as follows. In section 2 we sketch some analyses which have been proposed for PDSNCs, and at the same time look at some data which are problematic for them. Sections 3 and 4 look at two possible analyses, both of which include important weaknesses. Section 5 presents the functor analysis and we look at how it is able to deal with the facts. In section 6 we also look at some further data which we argue is no problem to our approach. Section 7 is the conclusion.

2 Earlier Approaches

The PDSNCs have been discussed in many places, including studies from the viewpoint of meaning and function (Keizer 2007) and the diachronic development (Denison 2002, De Smedt et al. 2007, Davidse et al. 2008, Brems & Davidse 2010, Brems 2011). It seems that there are no fully worked out analyses of the synchronic syntactic properties of the constructions, but the above studies touch upon some of them.

Some suggest that the determiner, the *sort*-noun and *of* make a group, constituting a complex determiner (De Smedt et al. 2007, Davidse et al. 2008, Brems & Davidse 2010, Brems 2011). This is schematically represented as follows.

- (6) [complex determiner: *these sort of*][head: *skills*]

However, there are at least two reasons for rejecting this view. First, it is possible to put an adjective before the *sort*-noun, as the following examples illustrate (see also Kim & Moon (2014:530)).

- (7) a. these *steady-state* type of organisations
(BYU-BNC²: CM0 W_commerce)
b. these *weird* sort of criticisms
(COCA³: 2009 SPOK NPR_TellMore)
c. those *feminine* kind of things (COCA: 1991 FIC AntiochRev)
d. those *needy* sort of Americans (COCA: 1990 ACAD Raritan)

²Davies (2004-)

³Davies (2008-) The Corpus of Contemporary American English

It seems, then, that both of the complex determiner approach and the postdeterminer approach contain some problems. In the rest of this article we will provide an analysis without such problems in the framework of HPSG. We will look at three possible HPSG analyses. Two of them appear to be unsatisfactory, but the third seems to give a satisfactory account of the facts.

3 Weak Head Analysis

We have argued that in PDSNCs the determiner agrees with NP after *of*. One might argue that this agreement pattern is possible if the *sort*-noun and the preposition *of* function as weak heads. A weak head is a lexical head which shares the HEAD (H) value and some other important properties with its complement (Tseng 2002, Abeillé et al. 2006). Both the *sort*-noun and the preposition *of* can be treated as weak heads. With this mechanism, we would have structures like (10).

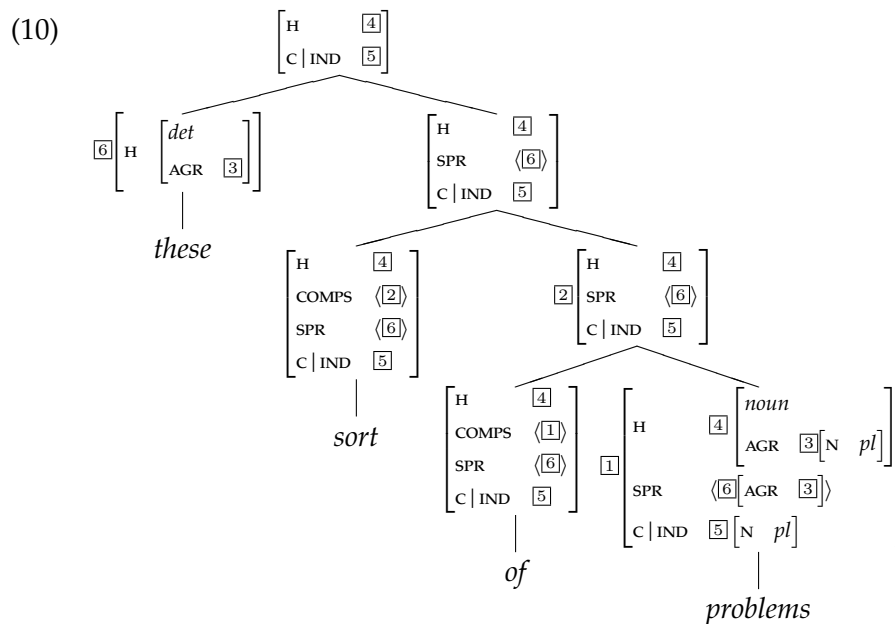

As a weak head, the preposition *of* shares the SPR value with its complement, *problems*. It is propagated to the mother node, which is a complement of the *sort*-noun. The *sort*-noun then inherits the SPR value as a weak head. The value finally reaches the phrase *sort of problems*. This enables the combination of *these* and *sort of problems* because the latter inherits the SPR value from *problems*.

This analysis can handle the problems noted with the earlier approaches (Section 2). First, the determiner, the *sort*-noun and *of* do not make a complex determiner, so it is possible for an adjective to intervene between the

determiner and the *sort*-noun, as in (7). Second, the examples in (8) can be accommodated if we assume that the complement of the *sort*-noun is optional. Finally, this analysis is free from the unclear notion of ‘postdeterminer’.

It appears that the notion of weak head plays a role in explaining the pattern of agreement with the verb when a PDSNC is a subject. The following example shows that a PDSNC subject causes plural agreement with the verb.

- (11) Well I’d actually expect that *those sort of courses* **are**/***is** very uh heavily subscribed uh, heavy just like *these sort of problems* **are**/***is** very hard to solve. (Keizer 2007: 175; adapted from ICE-GB)

In (11) subject-verb agreement is triggered by *courses* and *problems*, respectively. This means that the grammatical number of the full NP is determined by the grammatical number of the NP which is the complement of *of*. To capture this, let us assume that a weak head preserves the INDEX (IND) value of its complement on the mother node. In (10) the preposition *of* preserves the *plural* value of the IND feature of its complement on the mother node. That value is further preserved by another weak head, *sort*, on the full NP. The IND feature represents what the expression refers to in the real world, and its value determines the form of subject-verb agreement (Kathol 1999, Wechsler & Zlatić 2003, Kim 2004). In (10) the value of the IND feature that is propagated to the full NP is [N *pl*], which indicates that the expression with this property is semantically singular.⁶ The propagation of the IND value described above ensures that the *plural* value of the IND|N feature is propagated to the full NP node from the complement of *of*.

Thus, the weak head analysis outlined above appears to be able to deal with determiner-noun agreement and subject-verb agreement that PDSNCs show. However, there is an objection to this analysis. (10) shows that the IND|N value of the *sort*-noun is identical to that of the complement of *of*. This entails that the *sort*-noun and the complement of *of* are semantically plural. There is evidence against this view.

- (12) a. [This kind of dog] is dangerous.
 b. [These kind of dogs] are dangerous.
 c. [These kinds of dogs] are dangerous.
 (Huddleston & Pullum 2002:352)

Huddleston & Pullum (2002:353) states that ‘[t]he meaning of the bracketed NP in [(12b)] is like that of the one in [(12a)] in that we have a single kind of dog, not a plurality, as in [(12c)]’. Following this statement, we can assume that the *sort*-noun in PDSNCs has a singular interpretation. It is clear that

⁶The N (NUMBER) value represents the information about the grammatical number (Section 1).

the singular interpretation of the *sort*-noun is not compatible with the weak head analysis outlined above, which requires it to have a plural interpretation.

It seems, then, that the weak head analysis is unsatisfactory.

4 Transparent Head Analysis

One might employ ‘transparent heads’ to allow the propagation of information from non-heads to phrases. Flickinger (2008) observes that in partitive NPs as in (13), where the partitive head *some* takes as its complement a PP headed by *of*, the grammatical number of the full NP is determined by the grammatical number of the complement NP of *of*.

- (13) a. Some of the rice is ruined.
 b. Some of the books are ruined.
 c. *Some of the rice are ruined.
 d. *Some of the books is ruined. (Flickinger 2008:90)

Flickinger (2008) introduces the *MINOR* feature as a *HEAD* feature so that a head selecting for a complement can preserve some properties of the complement on the phrase. The transparent head *of* in (13) identifies its *MINOR* value with that of their complement. The value is then propagated to the mother by the head feature principle. As another transparent head, the partitive head *some* also preserves the *MINOR* value of its complement and propagates it to the mother. If we assume that the number property is represented as a *MINOR* value, it can propagate up from the lower non-head and can be visible on the full partitive NP. The *MINOR* value of the full partitive NP then determines the form of subject-verb agreement.

A transparent head approach to PDSNCs would require that the *sort*-noun and *of* should identify their *MINOR* value with that of their respective complement. With this assumption, we will have structures like (14).

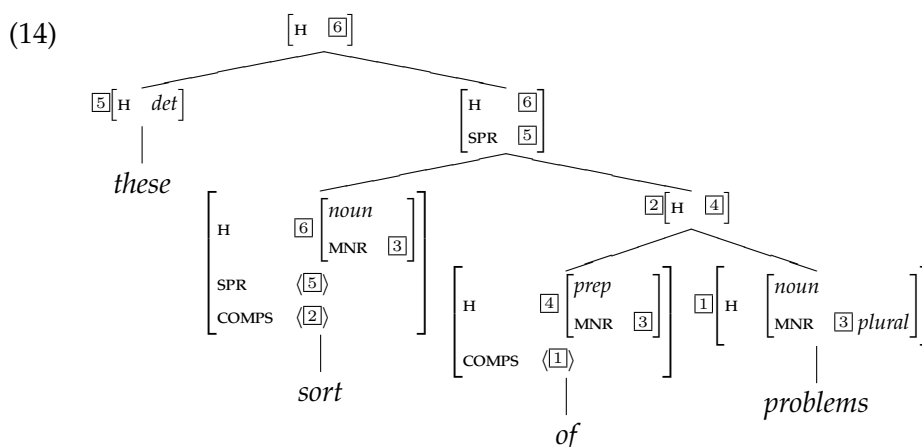

As in partitive NPs, *of* in (14) identifies its MINOR value with that of their complement. The value is propagated to the mother by the head feature principle. The *sort*-noun then inherits that MINOR value from its complement and passes it up to the mother. That value is again propagated to the full NP by the head feature principle. The grammatical number of the full NP is thus determined by the MNR value propagated from the complement of *of*.

This analysis can avoid the problems noted with the earlier approaches (Section 2), as can the weak head approach outlined in the last section: it is possible for an adjective to intervene between the determiner and the *sort*-noun, as in (7); it is easy to make the complement of the *sort*-noun optional as in (8); and this analysis does not employ a postdeterminer as a syntactic position.

However, the objection that we raised against the weak head approach is also applicable here. (14) shows that the MNR value of the *sort*-noun is identical to that of the complement of *of*. This means that the grammatical number of the *sort*-noun is the same as that of the complement of *of*: they are both plural. This is incompatible with the fact that the *sort*-noun in PDSNCs has a singular interpretation (12).

It seems, then, that the transparent head analysis too is unsatisfactory.

5 Functor Analysis

We will turn now to an analysis which we think provides a satisfactory account of the data. This is an analysis in which the determiner, the *sort*-noun and the preposition *of* are functors: non-heads which select the head (Van Eynde 2006, Allegranza 1998).⁷

5.1 Functors

We assume that a singular determiner *this* has a partial lexical description like the following.

$$(15) \text{ this: } \left[\begin{array}{l} \text{HEAD} \\ \text{MRK } \textit{marked} \end{array} \left[\begin{array}{l} \textit{determiner} \\ \text{AGR } \boxed{1} \text{ [N sg]} \\ \text{SEL } \left[\begin{array}{l} \text{HEAD } \left[\begin{array}{l} \textit{noun} \\ \text{AGR } \boxed{1} \end{array} \right] \end{array} \right] \end{array} \right] \end{array} \right]$$

⁷The analysis provided in this section is partly based on the ideas given in Maekawa (2010).

Those non-heads that select the heads are called functors. The information about selection is indicated by the *SEL* (*SELECT*) feature of a non-head, and it represents the constraints which the non-head daughter imposes on the head daughter. The *SEL* value of (15) shows that *this* selects a singular noun. The *AGR* value [1] shared between *this* and its head noun means determiner-noun agreement between them. *MARKING* (*MKG*) indicates whether the expression involves a determiner or a numeral, or whether it can stand alone without these elements (Van Eynde 2006). The *marked* value means that the expression contains a determiner or is a determiner itself.

The combination of a determiner and a head nominal is an instance of a head-functor phrase, which is subject to the following constraint (Van Eynde 2006:164,166).

$$(16) \quad hd\text{-funct-ph} \rightarrow \left[\begin{array}{l} \text{MRK} \quad [1] \\ \text{DTRS} \quad \left\langle \left[\begin{array}{l} \text{MRK} \quad [1] \\ \text{SEL} \quad [2] \end{array} \right], [3] \left[\text{SYNSEM} \quad [2] \right] \right\rangle \\ \text{H-DTR} \quad [3] \end{array} \right]$$

The constraint in (16) states that in a phrase of type *head-functor-phrase* (*hd-funct-ph*) the non-head daughter selects the head daughter, and the *MRK* value of the mother is token-identical to that of the non-head daughter.

Let us see how functor *this* combines with a singular countable noun.

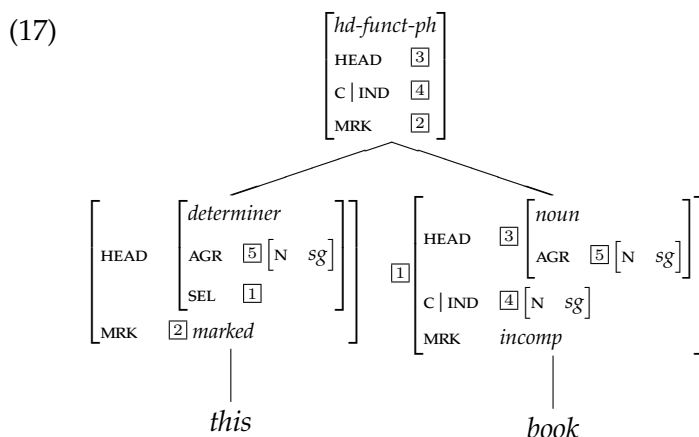

The *MKG* feature of *book* has a value whose type is *incomplete* (*incomp*), which means that the word is incomplete on its own, requiring some sort of determiner. In (17) both the *IND* | *N* and the *AGR* | *N* values of *book* are *sg*, indicating that it is a singular nominal. The combination shown in (17) is an instance of a head-functor phrase. In (17) *this* selects the head noun and the *MRK* value *marked* is inherited to the mother node. We assume that the *IND* value, as well as the *HEAD* value, is propagated from the head daughter to the mother

value of *of* is inherited to the mother node. See Van Eynde (2000, 2004, 2005) for analyses of some prepositions as functors.

5.2 PDSNCs

We will finally turn to the functor analysis of PDSNCs. We will first discuss what is the head of the PDSNCs. Let us consider (11), which is repeated in the following.

- (20) Well I'd actually expect that *those sort of courses* **are**/***is** very uh heavily subscribed uh, heavy just like *these sort of problems* **are**/***is** very hard to solve. [= (11)]

Here, the PDSNC subjects *those sort of courses* and *these sort of problems* show plural agreement with the verb. The agreement triggers are the nouns following *of*: *courses* and *problems*, respectively. Let us assume, then, that the noun following *of* is the head of the whole structure of PDSNCs.

Given the above discussions about the headedness of the PDSNCs, we can say that the *sort*-noun does not function as the head. Instead, we can propose that the *sort*-noun in PDSNCs is a functor, selecting the *of*-marked NP head-daughter. The partial lexical description of a functor *sort*-noun will look like the following.

- (21) *sort* (functor):
- $$\left[\begin{array}{l} \text{HEAD} \left[\begin{array}{l} \textit{noun} \\ \text{AGR} | \text{N} \quad \textit{sg} \\ \text{SEL} \quad \langle \left[\text{MRK} \quad \textit{of} \right] \rangle \end{array} \right] \\ \text{MRK} \quad \textit{incomp} \\ \text{C} \quad \left[\text{IND} | \text{N} \quad \textit{sg} \right] \end{array} \right]$$

(21) states that the functor *sort*-noun selects an *of*-marked head-daughter. Note that the determiner requirement of a *sort*-noun as a singular countable noun is indicated by the *incomp* value of the MRK feature.

Our syntactic analysis of a PDSNC is given in (22).

'this/that kind of car/cars'

(Broekhuis & den Dikken 2012:631)

Here, *soort* is a Dutch *sort*-noun, and it is directly followed by the bare nominal *auto/auto's* 'car/cars'. Thus, we can say that a *sort*-noun selects an NP in both English and Dutch.

(22)

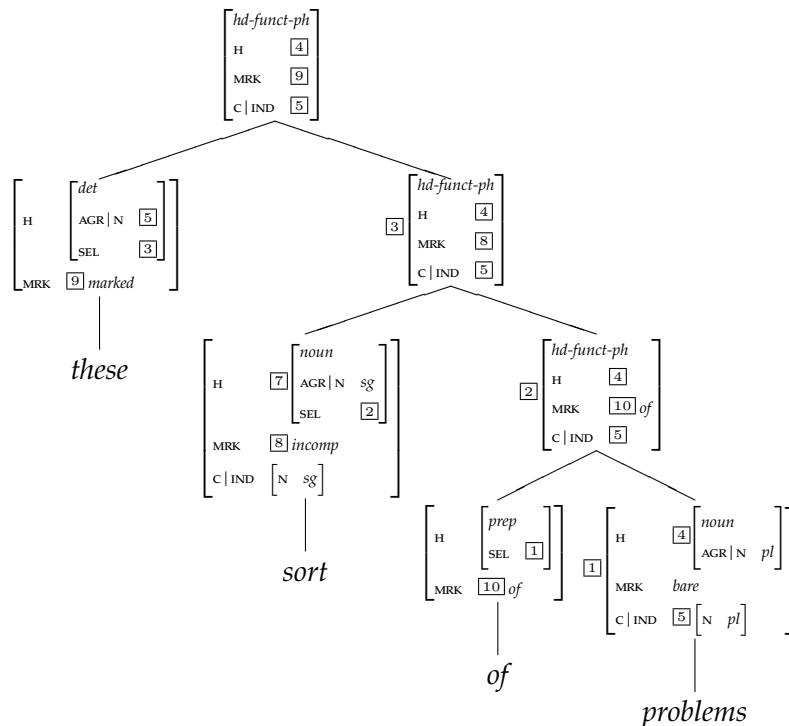

We have already seen above how the *of*-phrase is constructed, so we will not discuss it here. The *sort*-noun in this construction is a functor with the property in (21). As a functor, it selects the *of*-marked phrase via the SEL value [2]. In this head-funct phrase the *sort*-noun is a non-head daughter, and the head-daughter is *of problems*. The HEAD and C | IND values of the mother node come from the head daughter. The *pl* value of AGR | N, which is propagated from *problems* via the HEAD feature, enables this phrase to combine with the plural determiner *these*. The combination of the determiner with the head nominal is an instance of a head-funct phrase, as discussed in section 5.1. Therefore, the MRK value *marked* is inherited from *these* to *these sort of problems*.

The AGR | N and IND values of the top node come from *sort of problems*. Because these values originally come from *problems*, the whole phrase is plural both morpho-syntactically and semantically. The semantic plurality accounts for the plural agreement with the verb, illustrated in (11). The morpho-syntactic plurality accounts for the plural agreement with the determiner.

It is important to note here that the determiner requirement from the *sort*-noun as a singular countable noun is fully satisfied in (22). It is the plural determiner that satisfies this requirement. Agreement mismatch does not occur here because the determiner and the *sort*-noun do not have a determiner-head relationship. The head of the whole structure is the plural noun *problems*, with which the determiner has an agreement relationship

via the $\text{AGR} | \text{N}$ feature. This analysis is possible because the determiner requirement and the determiner-noun agreement are represented separately in our approach.

This approach can capture the facts in (7) and (8), which, as discussed in section 2, are problematic to the earlier analyses of PDSNCs. The relevant parts of (7) and (8) are repeated in (23) and (24), respectively.

- (23) a. these *steady-state* type of organisations
b. these *weird* sort of criticisms
c. those *feminine* kind of things
d. those *needy* sort of Americans

- (24) a. (...), *these type* never do.
b. But *these kind* are good for us.
c. (...), and *those sort* were precious few.

First, the determiner, the *sort*-noun and *of* do not make a complex determiner in our approach, so it enables an adjective to intervene between the determiner and the *sort*-noun, as in (23). Second, the preposition *of* and the following noun make a constituent, which makes it easy to delete it, as in (24). Finally, our analysis is free from the unclear notion of ‘postdeterminer’.

Moreover, our functor analysis is free from the problems involved in the other HPSG analyses which we discussed in the last two sections. The number mismatch between the *sort*-noun and the head noun do not occur in our analysis because the *sort*-noun do not preserve the grammatical number of the head noun.

It seems, then, that our functor analysis is superior to the other analyses which we discussed.

6 Other Variations

In this section we will look at constructions which look like PDSNCs but are actually not. The functor analysis of *sort*-noun can be applied to some of these constructions. We will first consider the variants in which the *sort*-noun works as a head of the whole construction.

6.1 *Sort*-Noun as a Head

PDSNCs are ‘very informal and is considered incorrect by some people’ (OALD).¹⁰ According to Huddleston & Pullum (2002:353), however, they are ‘very well established, and can certainly be regarded as acceptable in informal style’. They are in contrast with the less informal variants, which are often found in dictionaries. Some of them are illustrated in the following.

¹⁰http://www.oxfordlearnersdictionaries.com/definition/english/kind_1

- (25) a. *This kind of question* often appears in the exam.
 b. *These kinds of questions* often appear in the exam. (OALD: *ibid*)

These variants, like PDSNCs, include a determiner, a *sort*-noun and an *of*-phrase. However, the *sort*-noun in these constructions agrees in number with the preceding determiner, in contrast with PDSNCs where the determiner and the *sort*-noun do not show number agreement.

The following example show that when these constructions are subjects, number agreement with the verb is induced by the number of the *sort*-noun.

- (26) *These sorts of behaviour* are not acceptable. (OALD: *ibid*)

In these examples the noun after *of* is an uncountable noun, which is always singular. (26), in which there is plural subject-verb agreement, shows that the *sort*-noun, not the noun after *of*, is the trigger of subject-verb agreement.

Now let us consider how these examples are analysed in HPSG. The structure for (25a) is given in (27).

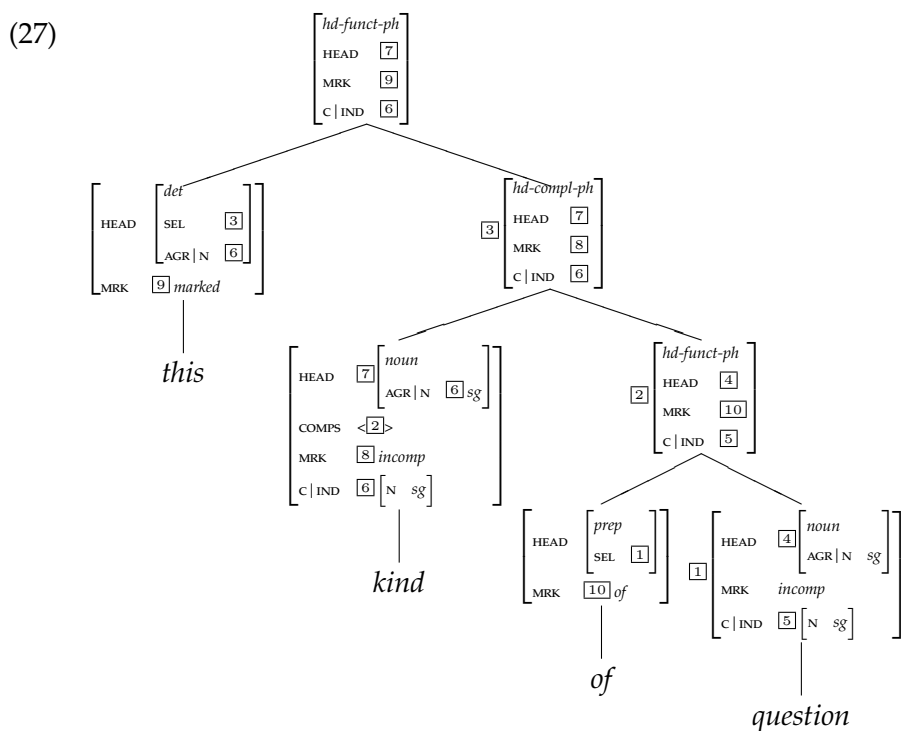

The *sort*-noun *kind* in (27) is a head, not a functor. As a singular countable noun, the AGR|N and the IND|N values are *sg*. The MRK value is *incomplete* (abbreviated as *incomp* here) as it needs a determiner in order to occur in NP positions. The COMPS list of *sort*-noun in (27) indicates that it takes a complement marked with *of*. The combination of *kind* and *of question* is a structure of a head-complement phrase (which is of type *head-complement-phrase* (*hd-compl-ph*)). Because it is a subtype of *hd-ph*, the AGR|N value *sg* is

inherited from *kind* to the mother node, which enables this phrase to combine with the singular determiner *this*. The *IND* value is also inherited from the head-daughter to the mother node, so the *sg* value reaches the top node. This makes the whole phrase semantically singular, which leads to the singular agreement with the verb when the phrase is in the subject position, as illustrated by (25a). Thus, the forms of determiner-noun agreement and subject-verb agreement are both determined by the properties of the head noun *kind*. Therefore, the form of *question* is irrelevant for the both types of agreement.

In (25b) and (26), the head of the whole structure is the plural nouns *kinds* and *sorts*, respectively. Their partial lexical description is something like the following.

(28) *sorts/kinds*:

$$\left[\begin{array}{l} \text{HEAD} \\ \text{COMPS} \\ \text{MRK} \\ \text{C} \end{array} \left[\begin{array}{l} \textit{noun} \\ \text{AGR} | \text{N} \quad \textit{pl} \\ \langle \text{MRK} \quad \textit{of} \rangle \\ \textit{bare} \\ \text{IND} | \text{N} \quad \textit{pl} \end{array} \right] \right]$$

(28), which is a partial lexical description of the plural common noun *sorts*, is the same as that of a singular *sort*-noun, except for the *AGR* | *N*, *IND* | *N* and *MRK* values. The former two are *pl*. The *MRK* value is *bare*, which indicates that *sorts* does not have to have a determiner to be used in NP positions. The forms of determiner-noun agreement and the subject-verb agreement are determined by the *AGR* | *N* and the *IND* | *N* values of *kinds/sorts*, respectively. In this structure they are both *pl*, indicating that both types of agreement should be in plural, as shown by (25b) and (26). The form of *questions/behaviour* is irrelevant for the purpose of agreement.

6.2 Variants with Agreement Ambiguity

There is a variant in which the nominal after *of* is the only plural element in the phrase.

- (29) a. this type of promoters (BYU-BNC: FTE W_ac_nat_science)
 b. this kind of activities (COCA: 1992 SPOK NPR_Weekend)
 c. this sort of things (COCA: 1999 MAG Money)

The structure in (27) also accommodates the variant in (29).^{11,12} In these examples the right-most noun is plural, but as discussed above, it is irrele-

¹¹The *MRK* value of the noun following *of* is *bare* in these cases.

¹²The following example is a supportive evidence for this claim.

vant for the both types of agreement because it is not the head. The head is the singular *sort*-noun, so it triggers singular agreement not just with the determiner but also with the verb. The following examples illustrate this.

- (30) a. (...) **this type of promoters** is more frequent in *B.subtilis* than in *E.coli* (11). (BYU-BNC: FTE W_ac_nat_science)
 b. **this kind of activities** is one of the most important for our bank. (COCA: 1992 SPOK NPR_Weekend)
 c. “**This sort of things** happens all the time,” Bradley says, (...) (COCA: 1999 MAG Money)

In the examples in (30) the singular *sort*-noun triggers singular agreement with the determiner and the verb.

An interesting point about the functor analysis of *sort*-nouns given in (21) is that it also allows the following structure, in which the combination of the determiner and the *sort*-noun acts as a complex functor, selecting the *of* phrase.

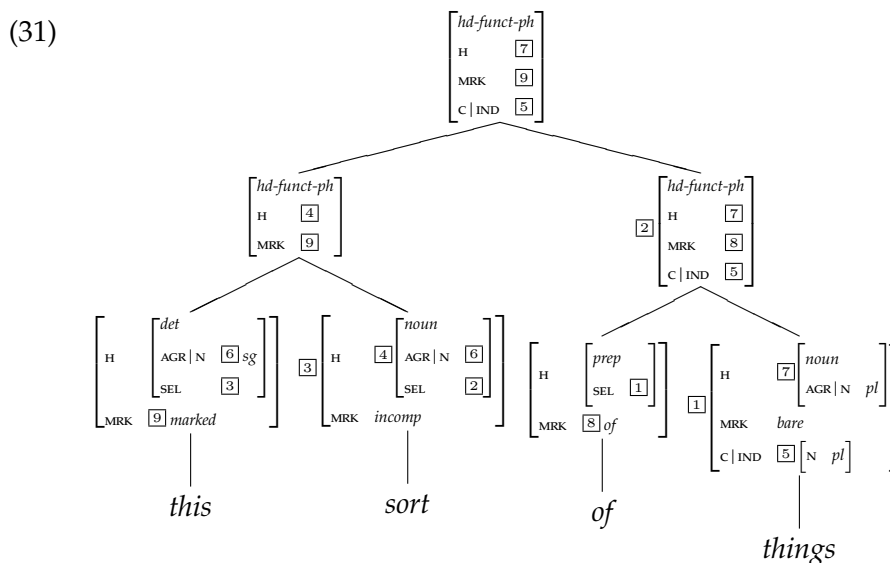

In (31) the determiner selects *sort*. It should be singular because its head is [AGR | N sg]. The SEL value of *sort* is inherited to the mother node because it

- (i) This kind of questions and sort of answers are/*is helpful.

In our approach this can be analysed as a case of N-bar coordination.

- (ii) this [_{N'} kind of questions] and [_{N'} sort of answers]

Determiner-noun agreement and subject-verb agreement in (12) have exactly the same patterns as the clear case of N-bar coordination such as the following.

- (iii) This boy and girl are/*is eating a pizza (King & Dalrymple 2004:70)

Thus, we can conclude that the NPs in (29) have structures like (27). I am grateful to Dan Flickinger for bringing this point to the my attention.

is a HEAD feature. Like PDSNCs, the head of the whole phrase is the head-daughter of the *of* phrase. If it is a plural NP, then the whole phrase is plural. This accounts for plural agreement with the verb.

- (32) a. This kind of rankings have given ammunition to conservatives
 (...) (COCA: 2001 NEWS CSMonitor)
 b. (...) this type of women like to be around rich and powerful men.
 (COCA: 2008 SPOK Fox_Gibson)

Now, note that this structure generates the same sequence as (29), i.e., singular D + singular *sort*-noun + of + plural N. The examples are repeated here.

- (33) a. this type of promoters
 b. this kind of activities
 c. this sort of things [= (29)]

Recall that our analysis of (33) assumed that the singular *sort*-noun was the head of the whole phrase, and it was responsible for the singular agreement both with the determiner and the verb, as in (30). Thus, our dual treatment of a *sort*-noun, as a head and a functor, accounts for the fact that the variant in (33) triggers both singular agreement (30) and plural agreement (32) with the verb.

The dual patterns of subject-verb agreement can be seen in the following pair as well, where the determiner is *one*.

- (34) a. My dear child, there is only *one kind of canals* that excites imagination. (COCA: 1999 FIC MassachRev)
 b. *One kind of policies* are the missions (...)
 (<http://middleburycampus.com/article/1-in-8700-glenn-lower/>)

In (34a) the *sort*-noun is the head, triggering singular agreement with the underlined elements. In (34b) *kind* is a functor and the head is *policies*, which accounts for the plural agreement with the verb.

7 Conclusion

This study started with the observation about singular countable nouns, and we made a tentative generalisation in (3), which is repeated here.

- (35) A singular countable noun in English requires a determiner and they should agree in number. [= (3)]

However, a *sort*-noun in PDSNCs does not seem to conform to this generalisation: it is a singular countable noun requiring a determiner, but the determiner satisfying this requirement is not in the agreement relation with

it. The determiner agrees with the NP following *of*. We claimed that a *sort*-noun in PDSNCs is a functor, a non-head selecting a head. We argued that the functor treatment of *sort*-nouns can provide a satisfactory account of the PDSNC data. We also suggested that the dual patterns of subject-verb agreement which one of the variants shows (e.g. *this sort of things*), observed in (30) and (32), can be accounted for by assuming that a *sort*-noun is ambiguous: it can be either a head of a full NP or a functor (21).

In HPSG it has been assumed that a determiner is a specifier of a head noun and the determiner-noun agreement is based on the *SPR* specifications of the head noun. In our analysis, however, the determiner-noun agreement is not based on the *SPR* specifications: it is dissociated from the determiner requirement of a singular countable noun. This enables the plural determiner to satisfy the determiner requirement of a singular *sort*-noun while agreeing with the head of the whole structure.

References

- Abeillé, Anne, Olivier Bonami, Danièle Godard & Jesse Tseng. 2006. The syntax of French *à* and *de*: An HPSG analysis. In Patrick Saint-Dizier (ed.), *Syntax and Semantics of Prepositions* (Text, Speech and Language Technology 29), 147–162. Springer Verlag.
- Allegranza, Valerio. 1998. Determiners as functors: NP structure in Italian. In Sergio Balari & Luca Dini (eds.), *Romance in HPSG*, 55–108. Stanford: CSLI Publications.
- Brems, Lieselotte. 2011. *Layering of Size and Type Noun Constructions in English*. Berlin: Mouton de Gruyter.
- Brems, Lieselotte & Kristin Davidse. 2010. The grammaticalization of nominal type noun constructions with *kind/sort of*: chronology and paths of change. *English Studies* 91. 180–202.
- Broekhuis, Hans & Marcel den Dikken. 2012. *Syntax of Dutch: Nouns and Noun Phrases*, vol. 2. Amsterdam: Amsterdam University Press.
- Davidse, Kristin, Lieselotte Brems & Liesbeth De Smedt. 2008. Type noun uses in the English NP: a case of right to left layering. *International Journal of Corpus Linguistics* 13. 139–168.
- Davies, Mark. 2004–. BYU-BNC (Based on the British National Corpus from Oxford University Press). <http://corpus.byu.edu/bnc/>.
- Davies, Mark. 2008–. The Corpus of Contemporary American English: 450 Million Words, 1990-Present. <http://corpus.byu.edu/coca/>.

- De Smedt, Liesbeth, Lieselotte Brems & Kristin Davidse. 2007. NP-internal functions and extended uses of the 'type' nouns *kind*, *sort* and *type*: towards a comprehensive, corpus-based description. In Roberta Facchinetti (ed.), *Corpus Linguistics 25 Years On*, 225–255. Amsterdam: Rodopi.
- Denison, David. 2002. History of the *sort of* construction family. Paper presented at ICCG2: Second International Conference on Construction Grammar, Helsinki.
- Flickinger, Dan. 2008. Transparent heads. In Stefan Müller (ed.), *The Proceedings of the 15th International Conference on Head-Driven Phrase Structure Grammar*, 87–94. Stanford: CSLI Publications. <http://csli-publications.stanford.edu/HPSG/9/>.
- Huddleston, Rodney & Geoffrey K. Pullum. 2002. *The Cambridge Grammar of the English Language*. Cambridge: Cambridge University Press.
- Hudson, Richard. 2004. Are determiners head? *Functions of Language* 11(1). 7–24.
- Kathol, Andreas. 1999. Agreement and the syntax-morphology interface in HPSG. In Robert D. Levine & Georgia Green (eds.), *Studies in Contemporary Phrase Structure Grammar*, 209–260. Cambridge and New York: Cambridge University Press.
- Keizer, Evelien. 2007. *The English Noun Phrase*. Cambridge: Cambridge University Press.
- Kim, Jong-Bok. 2004. Hybrid agreement in English. *Linguistics* 42(6). 1105–1128.
- Kim, Jong-Bok & Grace Ge-soon Moon. 2014. The SKT construction in English: A corpus-based perspective. *Linguistic Research* 31(3). 519–539.
- Kim, Jong-Bok & Peter Sells. 2008. *English Syntax: An Introduction*. Stanford: CSLI Publications.
- King, Tracy Holloway & Mary Dalrymple. 2004. Determiner agreement and noun conjunction. *Journal of Linguistics* 40. 69–104.
- Maekawa, Takafumi. 2010. Dependency structure vs. phrase structure: two analyses of English determiners. *Hokusei Review, Junior College* 8. 51–62.
- Pollard, Carl J. & Ivan A. Sag. 1994. *Head-driven Phrase Structure Grammar*. Chicago: University of Chicago Press.
- Quirk, Randolph, Sydney Greenbaum, Geoffrey Leech & Jan Svartvik. 1985. *A Comprehensive Grammar of the English Language*. London: Longman.

- Sag, Ivan A., Thomas Wasow & Emily M. Bender. 2003. *Syntactic Theory: A Formal Introduction*. Stanford: CSLI Publications.
- Sinclair, John (ed.). 1990. *The Collins COBUILD English Grammar*. London: Collins.
- Tseng, Jesse L. 2002. Remarks on marking. In Frank Van Eynde, Lars Hellan & Dorothee Beermann (eds.), *Proceedings of the 8th International Conference on Head-driven Phrase Structure Grammar*, 267–283. Stanford: CSLI Publications. <http://csli-publications.stanford.edu/HPSG/2/>.
- Van Eynde, Frank. 2000. On the notion 'minor preposition'. In A. Kathol & D. Flickinger (eds.), *Proceedings of the 7th International Conference on Head-driven Phrase Structure Grammar*, 81–99. Stanford University: CSLI Publications. <http://web.stanford.edu/group/csli-publications/csli-publications/HPSG/2000/>.
- Van Eynde, Frank. 2004. Minor adpositions in Dutch. *The Journal of Comparative Germanic Linguistics* 7. 1–58.
- Van Eynde, Frank. 2005. Minor prepositions in nominal projections. In Aline Villavicencio & Valia Kordoni (eds.), *Proceedings of the 2nd ACL-SIGSEM Workshop on Prepositions and their Use in Computational Linguistics Formalisms and Application*, 54–63. Colchester: Association for Computational Linguistics.
- Van Eynde, Frank. 2006. NP-internal agreement and the structure of the noun phrase. *Journal of Linguistics* 42(1). 139–186.
- Van de Velde, Freek. 2009. Do we need the category of postdeterminer in the NP? *Transactions of the Philological Society* 107(3). 293–321.
- Van de Velde, Freek. 2011. Left-peripheral expansion of the English NP. *English Language and Linguistics* 15(2). 387–415.
- Wechsler, Stephen & Larisa Zlatić. 2003. *The Many Faces of Agreement*. Stanford: CSLI Publications.