

**Proceedings of the 12th International Conference on  
Head-Driven Phrase Structure Grammar**

Department of Informatics, University of Lisbon

Stefan Müller (Editor)

2005

Stanford, CA: CSLI Publications

The papers are published under a CC-BY license:  
<http://creativecommons.org/licenses/by/4.0/>

## **Contents**

<b>Editor's note</b>	<b>5</b>
<b>I Contributions to the Main Conference</b>	<b>6</b>
<b>Douglas Ball: Tongan noun incorporation: Lexical sharing or argument inheritance</b>	<b>7</b>
<b>John Beavers: Towards a semantic analysis of argument/oblique alternations in HPSG</b>	<b>28</b>
<b>Núria Bertomeu, Valia Kordoni: Integrating pragmatic information in grammar: An analysis of intersentential ellipsis</b>	<b>49</b>
<b>Denis Creissels, Danièle Godard: The Tswana infinitive as a mixed category</b>	<b>70</b>
<b>Berthold Crysmann: Syncretism in German: A unified approach to underspecification, indeterminacy, and likeness of case</b>	<b>91</b>
<b>Scott Drellishak, Emily M. Bender: A coordination module for a crosslinguistic grammar resource</b>	<b>108</b>
<b>Dan Flickinger, Alexander Koller, Stefan Thater: A new well-formedness criterion for semantics debugging</b>	<b>129</b>
<b>Chikara Hashimoto, Francis Bond: A computational treatment of V-V compounds in Japanese</b>	<b>143</b>
<b>Anke Holler: On non-canonical clause linkage</b>	<b>157</b>
<b>Christopher Kennedy, Louise McNally: The syntax and semantics of multiple degree modification in English</b>	<b>178</b>
<b>Jong-Bok Kim, Ivan A. Sag: English object extraposition: A constraint-based approach</b>	<b>192</b>
<b>Jong-Bok Kim, Peter Sells: Copy constructions and their interaction with the copula in Korean</b>	<b>213</b>
<b>Yusuke Kubota: Toward a unified analysis of the scope interpretation of complex predicates in Japanese: Evidence from the light verb construction</b>	<b>232</b>

<b>Anna Kupść, Jesse Tseng: A new HPSG approach to Polish auxiliary constructions</b>	<b>253</b>
<b>Sun-Hee Lee: A trace analysis of Korean UDCs</b>	<b>274</b>
<b>Takafumi Maekawa: An HPSG approach to the <i>who/whom</i> puzzle</b>	<b>290</b>
<b>Nurit Melnik: From “hand-written” to computationally implemented HPSG theories</b>	<b>311</b>
<b>Ivan A. Sag: Adverb extraction and coordination: A reply to Levine</b>	<b>322</b>
<b>Jan-Philipp Soehn: Selectional restrictions in HPSG: <i>I’ll eat my hat!</i></b>	<b>343</b>
<b>Kathrin Spreyer, Anette Frank: Projecting RMRS from TIGER dependencies</b>	<b>354</b>
<b>Mehran A. Taghvaipour: Persian free relatives</b>	<b>364</b>
<b>Beata Trawinski: Plural comitative constructions in Polish</b>	<b>375</b>
<b>Frank Van Eynde: A head-driven treatment of asymmetric coordination and apposition</b>	<b>396</b>
<b>Gertjan van Noord, Valia Kordoni: A raising analysis of the Dutch passive</b>	<b>410</b>
<b>Aline Villavicencio, Louisa Sadler, Doug Arnold: An HPSG account of closest conjunct agreement in NP coordination in Portuguese</b>	<b>427</b>
<b>II Contributions to the Workshop</b>	<b>448</b>
<b>Nino Amiridze: Georgian reflexives in subject function in special contexts</b>	<b>449</b>
<b>António Branco: Reflexives: Escaping exemption via domain reshuffling</b>	<b>467</b>
<b>Réjean Canac-Marquis: Phases and binding of reflexives and pronouns in English</b>	<b>482</b>
<b>Martin Everaert: On binding domains</b>	<b>503</b>
<b>Lars Hellan: Implementing Norwegian reflexives in an HPSG grammar</b>	<b>519</b>
<b>Tohru Noguchi: Semantic composition in reflexivization</b>	<b>540</b>
<b>Carl Pollard: Remarks on Binding Theory</b>	<b>561</b>

<b>Eric Reuland: Binding conditions: How are they derived?</b>	<b>578</b>
<b>Jeffrey T. Runner, Elsi Kaiser: Binding in picture noun phrases: Implications for Binding Theory</b>	<b>594</b>
<b>Roland Stuckardt: Verifying binding constraints for anaphor resolution</b>	<b>614</b>

## Editor's note

The 12th International Conference on Head-Driven Phrase Structure Grammar (2005) was held at the Department of Informatics, University of Lisbon in Portugal.

The conference featured 2 invited talks, 18 papers, 2 alternate papers, and 6 posters selected by the program committee (Raul Aranovich, Doug Arnold, Emily Bender, Olivier Bonami, António Branco, Berthold Crysmann, Anke Holler, Valia Kordoni, Palmira Marrafa, Tsuneko Nakazawa, Gerald Penn, Alexander Rosen, Manfred Sailer (chair), Gautam Sengupta, Jesse Tseng, Stephen Wechsler, and Shuly Winter). A workshop on *Binding Theory and Invariants in Anaphoric Relations* was attached to the conference. It featured one invited talk and 12 papers, selected by the workshop program committee (Pilar Barbosa, António Branco (chair), Rejean Canac-Marquis, Mary Dalrymple, Martin Evearert, Volker Gast, Lars Hellan, Ehrard Hinrichs, Yan Huang, Tibor Kiss, Frank Keller, Valia Kordoni, Maria Pinango, Carl Pollard, Janina Radó, Eric Reuland, Jeffrey Runner, Ivan Sag, Roland Stuckardt, Ping Xue).

In total there were 39 submissions to the main conference and 13 submissions to the workshop. We want to thank the respective program committees for putting this nice program together.

Thanks go to António Branco, who was in charge of local arrangements.

As in the past years the contributions to the conference proceedings are based on the five page abstract that was reviewed by the respective program committees, but there is no additional reviewing of the longer contribution to the proceedings. To ensure easy access and fast publication we have chosen an electronic format.

The proceedings include all the papers except those by Frank Keller and Theodora Alexopoulou, Stefan Müller and Eric Reuland. Nurit Melnik submitted an extended abstract, the full paper will appear in a *Research on Language and Computation*.

**Part I**

**Contributions to the Main Conference**

# Tongan noun incorporation: Lexical sharing or argument inheritance

Douglas Ball 

Stanford University

Proceedings of the 12th International Conference on  
Head-Driven Phrase Structure Grammar

Department of Informatics, University of Lisbon

Stefan Müller (Editor)

2005

Stanford, CA: CSLI Publications

pages 7–27

Ball, Douglas. 2005. Tongan noun incorporation: Lexical sharing or argument inheritance. In Stefan Müller (ed.), *Proceedings of the 12th International Conference on Head-Driven Phrase Structure Grammar, Department of Informatics, University of Lisbon*, 7–27. Stanford, CA: CSLI Publications. DOI: 10.21248/hpsg.2005.1.



## Abstract

As has been shown in other Polynesian languages, in Tongan, adnominal elements can modify incorporated nouns in the noun incorporation construction. Two analysis are considered in this paper for understanding this construction within HPSG. The first, lexical sharing (Kim and Sells, this volume), views the verbs that include incorporated nouns as being single words corresponding to two syntactic atoms. However, this analysis makes incorrect predictions on the transitivity of incorporation clauses. A second analysis, extending Malouf (1999), views these words as verbs, but with some of the combinatorial properties of nouns. This offers both a better account of the data, and preserves the more restrictive theory of the morphology-syntax interface.

## 1 Introduction

In recent years, research into the morphosyntax of noun incorporation constructions in Polynesian languages has yielded several empirical advances.<sup>1</sup> In particular, Massam (2001) and Chung and Ladusaw (2004) have noted that noun incorporation in Niuean and Maori, respectively, does not always include just a verb and an incorporated noun, but can also include semantic modifiers of the incorporated noun. Thus, incorporation constructions in these languages are not simple verb-noun compounds or juxtapositions of verbs and nouns as earlier work (Mithun, 1984; Gerdts, 1998) claimed.

Thus, an element of this paper is to show that similar facts hold for another Polynesian language: Tongan. However, as I have noted elsewhere (Ball, to appear), the facts in Tongan are problematic both for analyses that try to analyze this construction purely in syntactic terms and for those that try to analyze this construction in purely morphological terms. Thus, I want to consider how this construction could be best understood within Head-driven Phrase Structure Grammar, where a one-sided analysis is not such a theoretical imposition, and where the mixed properties of this construction can easily be modeled.

This paper will proceed as follows: the next section will look in-depth at the facts surrounding noun incorporation in Tongan. At the same time, I will also give arguments for a particular configuration for this construction. I will then present two proposals for understanding this configuration. The first, to be presented in §3, is the Lexical Sharing analysis, which extends the work of Wescoat (2002). After offering some arguments against the Lexical Sharing analysis, I will discuss a second analysis in §4, one I will call the Argument Inheritance Analysis, which extends the work of Malouf (1999). The last section will give my conclusions.

---

<sup>†</sup>My thanks to Peter Sells, Ivan Sag, and John Beavers for their suggestions and help at numerous junctures in this research project. Thanks also to Jeff Runner, Danièle Godard, Jong-Bok Kim, and Rui Pedro Chaves for their discussion and questions at the conference as well as to two anonymous reviewers for their comments. The above are not responsible for any remaining shortcomings.

<sup>1</sup>Although there is a semantic effect in noun incorporation, as pointed out by Mithun (1984), and Tongan is no exception, I have yet to study the semantics systematically enough to discuss them in-depth here.



## 2 Data

### 2.1 Basics of Tongan Morphosyntax and Noun Incorporation

Tongan is a head-initial language and has an isolating morphological profile. The general pattern of linear order in phrases is as in (1):

- (1) Function Word(s) < Lexical Head < Adjuncts & Arguments

An example of this pattern is shown in (2a). Here, the verb *inu*, ‘drink,’ is preceded by a function word, the tense-aspect-mood (TAM) marker, *na’e*, ‘PAST’ and followed by its arguments, ‘*a e kava*, ‘the kava,’ and ‘*e Sione*, ‘Sione.’ Example (2a) also shows that a similar pattern exists within noun phrases: the pronominal function words ‘*a e*, ‘ABS the’ and ‘*e*, ‘ERG,’ precede their nouns, *kava* and *Sione*, respectively.

- (2) a. Ordinary Transitive Sentence  
Na’e inu ‘a e kavá ‘e Sione.  
PAST drank ABS DET kava.DEF ERG (name)  
‘Sione drank the kava.’ (Churchward, 1953, 76)
- b. Sentence with Incorporation  
Na’e **inu kava** ‘a Sione.  
PAST drink kava ABS (name)  
‘Sione drank kava.’ (Churchward, 1953, 76)

The examples in (2)<sup>2</sup> also illustrate the alternation between ordinary transitive clauses and those with incorporation. From the sentence in (2b), one can observe the two basic properties of noun incorporation in Tongan. First, case markers or determiners do not appear before the incorporated noun in noun incorporation. Second, the external argument is marked by the absolutive case in the noun incorporation construction. This contrasts with the external argument in (2a), which is marked by the ergative case.

### 2.2 Beyond the Verb and Noun in Tongan Noun Incorporation

As noted in the introduction, adnominal elements appear with and modify incorporated nouns in the Tongan noun incorporation construction. Examples (3)–(6) show some of these elements. These examples serve to illustrate the variety of categories that can appear as well as the fact that these adnominals can be quite phrasal. Above each example is the kind of adnominal appearing with the incorporated noun, while the actual adnominal in the example appears in italics.

- (3) Adjective  
Na’e **tā kītā** *fo’ou* ‘a Sione.  
PAST hit guitar new ABS (name)  
‘Sione played a new guitar.’

---

<sup>2</sup>All examples, unless otherwise noted, come from a Tongan speaker born in Tonga, now residing in the San Francisco Bay area.

- (4) Noun Conjunct  
 Na'e **tō manioke mo e talo** 'a Sione.  
 PAST plant cassava and taro ABS (name)  
 'Sione planted cassava and taro.'
- (5) Prepositional Phrase  
 Na'e **fakama'a sea 'i fale** 'a Sione.  
 PAST clean chair in house ABS (name)  
 'Sione cleaned chairs in the house.'
- (6) *ke*-clause  
 ...ke **kumi me'a ke nau nonofo ai.**  
 SBJV seek thing SBJV 3PL settle there  
 '...to seek a place to settle.'

In (4), the adnominal is a noun conjunct. However, the coordinator for NP conjunction, *mo*, is diachronically related to the preposition meaning 'with.' Given this connection, it seems reasonable to assume (as I will in this paper), that the structures and semantics of the adnominal PPs and noun conjuncts are reasonably similar. In (6), I refer to the adnominal as a *ke*-clause. This is a kind of relative clause that begins with the non-finite TAM marker, *ke*. This TAM marker is glossed as subjunctive (SBJV) following the traditional classification for this word (and its cognates) in the Polynesianist literature.

To talk about the parts of the noun incorporation construction, I want to define two (slightly) technical terms I will use throughout the rest of this paper. The term *adnominal* will be used, as above, for any word or phrase associated with and to the right of the incorporated noun in noun incorporation. It will also be used for the same words occurring in non-incorporated structures. The term *incorporate* will be used for the expression consisting of the incorporated noun and any adnominals with it.

### 2.3 Configuration of the Incorporation Construction

With adnominals potentially appearing in noun incorporation, there are a number of possibilities for dividing this construction into words and phrases. I claim that this construction has the configuration in (7):

- (7) [<sub>phrase</sub> [<sub>word</sub> Verb + Incorporated Noun] [<sub>phrase</sub> Adnominal(s) ] ]

This configuration is perhaps a bit striking in that it does not have the incorporated noun and the adnominal form a syntactic constituent; thus, the syntactic and semantic constituency is not isomorphic. Since this is the case, I want to motivate this configuration. I begin with motivating that the verb and the incorporated noun form a single word.

### 2.3.1 The Verb and Incorporated Noun Form a Word

The primary evidence for considering the verb and incorporated noun as a single word comes from the nominalization data. One of the few bits of derivation morphology in Tongan is the place nominalizer affix, -‘*anga*. Nouns with this suffix denote a place where a certain state of affairs (perhaps characteristically) occurs. Simplex verbs (as well as adjectives) can be nominalized by this affix, as shown in (8).

- (8) pule-‘anga  
rule-NMLZ  
‘kingdom, government’ (Churchward, 1959, 420), (my fieldnotes)

Beyond these simplex verbs, -‘*anga* can also appear with verb-noun units. This is shown in the examples in (9).

- (9) a. inu-kava-‘anga  
drink-kava-NMLZ  
‘place to drink kava’  
b. tō-talo-‘anga  
plant-taro-NMLZ  
‘place to plant taro’

From as early as Chomsky (1970), derivational processes such as nominalization have been considered to take place in the morphological/lexical part of the grammar. Since the data above show that noun incorporation, in some sense, “feeds” nominalization, the verb-noun unit itself must be considered to be formed morphologically, as well. Therefore, under the assumption of lexical integrity (Bresnan and Mchombo, 1995) standard in HPSG, it must be a single word in the syntax.

However, there is still an important remaining question: does this lexical unit extend to include all the incorporate? The data show that no, this lexical unit does not include all of the incorporate; instead, it only extends as far as the incorporated noun. The evidence for this comes from the behavior of verb-incorporate units in nominalization. They do not nominalize, as shown by (10).

- (10) a. V-N-Adj-‘anga  
\*fakatau-fale-hinehina-‘anga  
transact-house-white-NMLZ  
Intended: ‘place for selling white houses’  
b. V-N-PP-‘anga  
\*fakama‘a-sea-‘i-fale-‘anga  
clean-chair-in-house-NMLZ  
Intended: ‘place for cleaning the chairs from inside the house’

Thus, the evidence supports the configuration in (7), where the verb and the noun form one unit, to the exclusion of the adnominals.

The treatment of the verb and noun as a single word is corroborated by two other phenomena. The first is the behavior of incorporated nouns versus full NP arguments – which I will henceforth call term phrases – in scrambling.

As shown in (11), term phrases in Tongan can scramble (see Otsuka (2005) for further discussion of scrambling in Tongan).

- (11) a. ABS < ERG  
 Na'e tō 'a e manioke 'e Sione.  
 PAST plant ABS DET cassava ERG (name)  
 'Sione planted the cassava.'
- b. ERG < ABS  
 Na'e tō 'e Sione 'a e manioke.  
 PAST plant ERG (name) ABS DET cassava  
 'Sione planted the cassava.'

However, incorporated nouns cannot scramble; as (12) shows, they must be adjacent to the verb.

- (12) a. Na'e tō **manioke** 'a Sione.  
 PAST plant cassava ABS (name)  
 'Sione planted cassava.'
- b. \*Na'e tō 'a Sione **manioke**  
 PAST plant ABS (name) cassava

This is also true of multiword incorporates, where examples are acceptable when the verb and incorporate are adjacent, as in (13a), but not when the external argument appears between the verb and incorporate, as in (13b).

- (13) a. Na'e tō **manioke kano lelei** 'a Sione.  
 PAST plant cassava good ABS (name)  
 'Sione planted good cassava.'
- b. \*Na'e tō 'a Sione **manioke kano lelei**  
 PAST plant ABS (name) cassava good

This pattern further suggests the verb and incorporated noun form a single word, since the inability to scramble is a well known property of parts of words (cf. criterion (a) from Dixon and Aikhenvald (2002, 19) for a grammatical word).

A second phenomenon that corroborates the wordhood of the verb and incorporated noun is the behavior of prenominal adjectives with respect to incorporation. Though a majority of adjectives in Tongan are postnominal, some are prenominal, like *ki'i*, 'small,' shown in an ordinary sentence in (14).

- (14) Na'e tō 'e Sione 'ene *ki'i* manioke.  
 PAST plant ERG (name) his small cassava  
 'Sione planted his small amount of cassava.'

Including a prenominal adjective, such as *ki'i*, in an incorporate is unacceptable, as (15) reveals:

- (15) \*Na'e tō ***ki'i* manioke** 'a Sione.  
 PAST plant small cassava ABS (name)  
 Intended: 'Sione planted a small amount of cassava.'

This does not appear to be the result of purely semantic considerations, since an incorporate with the semantically similar, yet postnominal, adjective, *iiki*, ‘small’ is acceptable, as shown in (16).

- (16) Na‘e **tō manioke iiki** ‘a Sione.  
 PAST plant cassava small ABS (name)  
 ‘Sione planted a small amount of cassava.’

The evidence above shows that the verb and incorporated noun must be adjacent. This supports the view that the verb and incorporated noun form a single word, since strict adjacency is a necessary (though not sufficient) morphological property (a corollary of criterion (b) from Dixon and Aikhenvald (2002, 19) for a grammatical word).

Having argued that the verb stem and the incorporated noun form a single word, I will henceforth refer to this single word as the *incorporating verb*.

### 2.3.2 Adnominals Form a Constituent with the Incorporating Verb

Following insights from Massam (2001), I want to argue that the modifiers still form a phrase with the incorporating verb. The evidence for this comes from “verbal particles” – a class of adverbs – and their interaction with incorporation. The particles will be exemplified by *nai*, ‘maybe,’ here.

In transitive clauses, the particle appears between the verb and the first term phrase (cf. (Churchward, 1953, 207)), as shown in (17).

- (17) Na‘e kai *nai* ‘a e ika ‘e Sione?  
 PAST eat maybe ABS DET fish ERG (name)  
 ‘Sione ate the fish, didn’t he?’

In incorporation, the verbal particles must appear to the right of the whole incorporate, as in (18).

- (18) Na‘e **kai ika lahi** *nai* ‘a Sione?  
 PAST eat fish big maybe ABS (name)  
 ‘Sione eats a lot of fish, doesn’t he?’

*Nai* cannot appear inside the incorporate, as shown by (19).

- (19) a. \*Na‘e **kai** *nai* **ika lahi** ‘a Sione  
 PAST eat maybe fish big ABS (name)  
 b. \*Na‘e **kai ika** *nai* **lahi** ‘a Sione  
 PAST eat fish maybe big ABS (name)

From this data, I conclude that modifiers form a constituent with the incorporating verb that the “verbal particles” respect.<sup>3</sup>

Having argued for the structure in (7), the question then is how to understand the relationship between the adnominals and the incorporating verb. The next two sections will consider two proposals that do this.

<sup>3</sup>I also have very preliminary prosodic data that suggests the end of the incorporate is boundary of some sort, which also suggests this constituency, although these data need closer examination.

### 3 The Lexical Sharing Analysis

The first proposal I will consider is one I will refer to as the Lexical Sharing Analysis. This extends the work of Wescoat (2002), who first introduced this idea within LFG, and Kim et al. (2004), who first proposed it within HPSG (also see Kim and Sells (this volume)). I will first consider the details of this analysis, then offer arguments against it for Tongan noun incorporation.

#### 3.1 Analysis

The Lexical Sharing Analysis views incorporating verbs as an instance of a mismatch between morphological words and syntactic structure. Incorporating verbs are still regarded as single words, but, informally, such verbs are simultaneously linked to both a verb and noun “node” in the syntactic structure, which, in turn, licenses both the nominal and verbal behavior.<sup>4</sup>

To implement this idea, a few architectural changes must be made. First, instead of building phrases directly out of words, under Lexical Sharing, phrases are built up from the analog of preterminal nodes in other theories, units I will call *atoms*, following Kim et al. (2004). Second, the atoms must be linked to the words. Following Kim and Sells (this volume), this relationship will be mediated by two features. Declared for the type *word* is the feature `INST(ANTIATE)S`. It takes as its value a list of `SYNSEMS` that are linked to that word. This creates a correspondence between the words and the “nodes.” For most words, the `INSTS` list will be a singleton list; for lexically shared words, it will be a non-singleton list.

Declared for the supertype of *atom* and *phrase – sign* – are the attributes `SYNSEM` and `YIELD`. For `SYNSEM`, I will take the standard view on this feature, following Pollard and Sag (1994). The `YIELD` feature, on the other hand, takes a list for its value, and points to the `PHON` value(s) that the phrase or atom is related to, thus linking the “nodes” to the words. However, since the `YIELD` values for different signs are not necessarily unique (as is shown in (20) below), a mother’s `YIELD` value is not just the `YIELD` values of the daughters appended together. Rather, the mother’s `YIELD` value is related to those of its daughters by the function, *unique*. *Unique* is a function on lists and contracts a list to its unique members. It will eliminate one member of any two adjacent, identical occurrences of a given list element (Kim and Sells, this volume). If the identical members are not adjacent, then *unique* is undefined. A concrete example of how *unique* works will be given in example (21) and in the discussion thereafter.

Turning to an example, the structure for the incorporating verb from (13a) is given in (20).

---

<sup>4</sup>This analysis is conceptually very similar to a linearization-style analysis (e.g. Kathol (2000)) that would have compaction of a verb and noun in the phenogrammar (the linear precedence component) while the verb and noun would be part of separate phrases in the tectogrammar (the immediate dominance component).

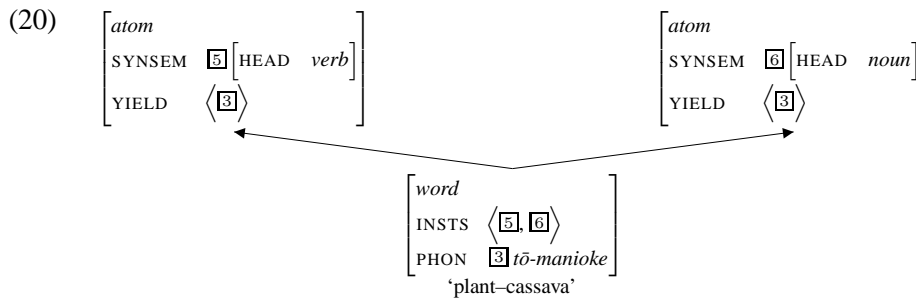

As (20) shows, *tō-manioke*, ‘plant cassava,’ is a lexically shared word. The PHON values of the two parts, *tō*, ‘plant’, and *manioke*, ‘cassava,’ are combined in the lexicon to form a compound. *Tō-manioke* is also specified, in this resulting lexical description, to have a two-element INSTS list, connecting this word with a verbal SYNSEM ([5]) and a nominal SYNSEM ([6]). As (20) shows, on the other side of the structure, the two atoms both have the same YIELD value: a list containing [3], which identifies both of them as having the PHON value *tō-manioke*.

With the incorporating verbs having the structure in (20), the structure of the clause from (13a) – minus the clause-initial TAM marker – is as in (21):

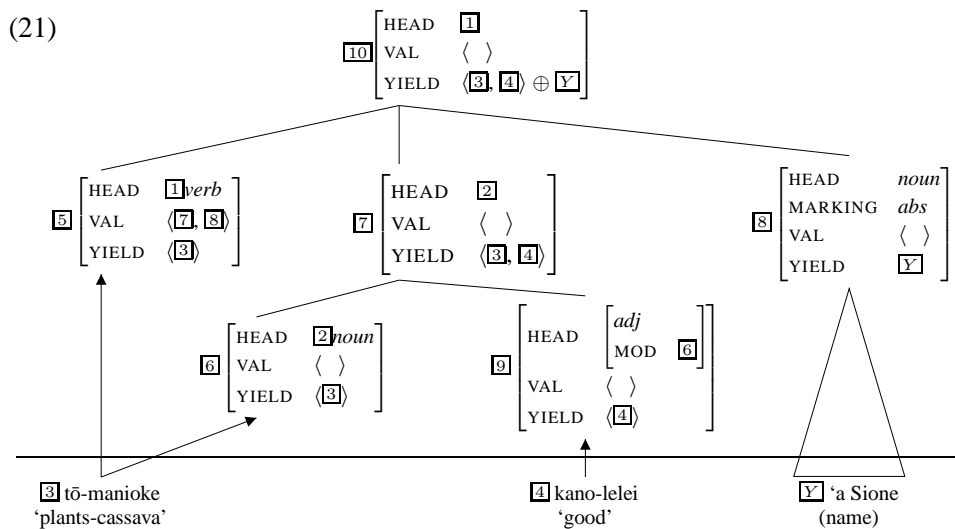

Building the tree in (21) from the bottom up, the nodes labeled [5] and [6] are present and adjacent due to *tō-manioke*’s lexical description. Beyond this, no other atoms are lexically-shared. All the atoms are combined using nothing more than schemata from Pollard and Sag (1994). The phrase labeled [7] is created when the head-modifier schema combines [6] and [9] together, due to [9]’s MOD feature.<sup>5</sup> Then, the head-complements schema or head-subject-complements schema,<sup>6</sup> combines the valents of the verb ([7] and [8])<sup>6</sup> together to form the phrase, [10]. Thus, under

<sup>5</sup>I won’t take a stand on which one at this point, but the issue is whether Tongan has a SUBJ category or not. I will offer some further comments on this issue in §4.3.

<sup>6</sup>Here and elsewhere, I assume the MARKING theory of Abeillé et al. (to appear) for the syntax of the case markers in Tongan, although nothing crucial hinges on it.

Lexical Sharing, the geometry is a bit non-standard at the lexical level, but above that level, the syntax works in an ordinary fashion.

Looking at the YIELD values of the daughters of [10], observe that there are two instances of [3]. However, they are adjacent. This, then, fulfills *unique*'s adjacency requirement, so, only one [3] is passed up to node [10]. Thus, lexically shared words are mutually constrained: first, from the lexicon via their INSTS value and, second, from the syntax, by the *unique* function's restriction to just apply to adjacent, identical YIELD list members.

## 3.2 Arguments Against a Lexical Sharing Analysis

The Lexical Sharing Analysis, however, suffers from a significant empirical problem: it incorrectly predicts how incorporating verbs will behave with respect to case marking and relativization, two phenomena sensitive to the number of arguments a verb has. Furthermore, corrections to fix this problem lead to other problems. Let us more closely examine these empirical facts and their theoretical ramifications below.

### 3.2.1 Evidence for Intransitivity

The first bit of evidence for intransitivity comes from the kind of case marking the external argument has. As mentioned earlier, in the discussion of example (2b), the external argument is in the absolutive case in the noun incorporation construction. This follows the pattern of other intransitive verbs, such as the one in (22), where the only (core) argument is marked with the absolutive.

- (22) Na'e 'alu nai 'a Sione?  
 PAST go maybe ABS (name)  
 'Sione went, didn't he?'

So, case marking shows that incorporating verbs pattern with intransitives. Furthermore, there is a second syntactic phenomenon that also shows that incorporating verbs pattern in the same way as intransitives: relativization.

In Tongan, transitive and intransitive clauses behave differently with respect to relativization. Transitive clauses require a resumptive pronoun (*ne* in (23)), and not a gap, if their subject is relativized. This is shown in (23).<sup>7</sup>

- (23) Kuo u sio ki he tangata na'a ne/\*\_\_ tō 'a e talo.  
 PERF 1SG see to DET man PAST 3SG/(gap) plant ABS DET taro  
 'I saw the man who planted the taro.'

In contrast, intransitive clauses require gap if their subject is relativized, as shown in (24):

- (24) Kuo u sio ki he tangata na'e \_\_/\*ne tangi.  
 PERF 1SG see to DET man PAST (gap)/3SG cry  
 'I saw the man who cried.'

<sup>7</sup>The location of the gap is not critical in this and the following examples.



In clauses with incorporation, a gap is also required, just like the intransitives.

- (25) Kuo u sio ki he tangata na'e \_\_\_/\*ne **fakatau kahoa**.  
 PERF 1SG see to DET man PAST (gap)/3SG sell necklace  
 'I saw the man who sold necklaces.' (cf. (Mithun, 1984, 851))

So, again, the data shows that clauses with incorporation pattern with intransitive clauses.

Additionally, there are a few bits of circumstantial evidence for the intransitivity of basic clauses with incorporation.<sup>8</sup> First, there is no possibility for doubling, as shown by (26).

- (26) \*Na'e **kaiha'a lolo** 'e Sione 'a e M&M's  
 PAST steal candy ERG (name) ABS DET (kind of candy)  
 Intended: 'Sione candy-stole the M&M's.'

There is also no possibility of "discontinuous stranding" (considering the adnominals discussed earlier as a kind of "continuous stranding"), as shown in (27).

- (27) \*Na'e **kai ika** 'a/e Sione 'a e lahi  
 PAST eat fish ABS/ERG (name) ABS DET big  
 Intended: 'Sione fish-ate the big (one).'

These properties of doubling and discontinuous stranding are frequently found with valence-maintaining noun incorporation (Rosen, 1989; Runner and Aranovich, 2003), and, as far as has been researched, have never been found with valence-reducing noun incorporation. To the extent that these trends reflect actual universals of human language, these also suggest that Tongan noun incorporation is valency-reducing.

Overall, these findings from the above match the claims by Runner and Aranovich (2003) and Rosen (1989) that Tongan has valence-reducing noun incorporation

### 3.2.2 Problems for Lexical Sharing

Given standard assumptions in HPSG about case marking (Przepiórkowski, 1999; Runner and Aranovich, 2003) and relativization (Bouma et al., 2001; Sag, this volume), both these phenomena must be constrained on the ARG-ST list and not on the VAL list. Since, as (21) shows, the crux of the Lexical Sharing analysis is that incorporating verbs are bivalent – and, by the argument realization principle, two-termed (transitive) on the ARG-ST list – the Lexical Sharing Analysis makes the wrong predictions about the behavior of the incorporating verbs.

Yet, there seems to be a possible fix. Under this possible alternative, the incorporated noun is realized as an argument of type *non-canonical* on the ARG-ST list (as suggested by Malouf (1999); also Runner and Aranovich (2003) for valence-maintaining incorporation). The constraints done on ARG-ST would then just need

---

<sup>8</sup>Clauses with incorporation are not universally intransitive in Tongan: they can be transitive if an oblique is "promoted" to object.

to treat the *non-canonical* argument as invisible for their purposes. However, regardless of how feasible such constraints may or may not be, this proposal suffers from a more fundamental, though theory-internal problem: If the incorporate is realized on the ARG-ST list, but not on the VAL list, there is no way to lexically integrate it into a schema – the incorporating verb will not select for the incorporate and it will hang there, unattached. Thus, these problems lead me to reject the Lexical Sharing Analysis and to seek an analysis that treats this construction as intransitive.

## 4 The Argument Inheritance Analysis

Having argued against the Lexical Sharing Analysis, I want to next consider an analysis that fixes the above problems. I will term this analysis the Argument Inheritance Analysis.<sup>9</sup> This analysis takes as a starting point Malouf (1999)’s analysis of West Greenlandic denominal verbs (arguably a kind of noun incorporation), and extends it to handle the facts surrounding Tongan noun incorporation. The key idea, as in Lexical Sharing, is that the incorporating verbs are a kind of “mixed category.” However, in the Argument Inheritance Analysis, this is implemented in a slightly different way: the incorporating verbs are categorically verbs, but, are special kinds of verbs with some of the combinatorial properties of nouns and as well as the combinatorial properties of verbs.

### 4.1 Background Assumptions

Critical to this analysis is how to analyze the relevant combinatorics of nouns: that is, how nouns combine with adnominal modifiers. I will follow recent work (Bouma et al. (2001), Przepiórkowski (1999), and especially Malouf (1999)) in viewing heads as the selectors of so-called adjuncts, in contrast to the proposal in Pollard and Sag (1994), where the adjuncts select for their heads. However, instead of straightforwardly following the “adjuncts-as-complements” analysis, I will assume that adnominals are selected via an ADJ(unct) feature,<sup>10</sup> which has a list as its value, and this list, in turn, is an value of the VAL feature. Thus, the geometry is closer to that presented in Sag et al. (2003), where modifiers are selected through a particular VAL feature.<sup>11</sup>

Turning now to the question of how adnominals appear on a given noun’s ADJ list, I assume that are placed there via the optional lexical rule given in (28), which closely follows the adjunct lexical rule of Malouf (1999, 56):

---

<sup>9</sup>A conceptually similar analysis would be to take the incorporating verbs as a mixed category that could be modified by adjectives. Due to space limitations, I won’t consider this analysis here.

<sup>10</sup>This bears a superficial resemblance to the theory of modifiers presented in Pollard and Sag (1987).

<sup>11</sup>I will assume that the elements on the ADJ list do not appear on the ARG-ST list, although this does not seem to be a critical assumption.

$$(28) \left[ \begin{array}{l} \text{RESULT} \\ \text{SOURCE} \end{array} \left[ \begin{array}{l} \text{HEAD } \textit{noun} \\ \text{VAL} \left[ \begin{array}{l} \text{COMPS } \boxed{C} \\ \text{ADJ} \left\langle \left[ \text{CONT } \boxed{5} \right] \right\rangle \end{array} \right. \\ \left. \text{CONT } \boxed{5} \left[ \text{ARG } \boxed{4} \right] \right. \end{array} \right] \right]$$

In short, (28) says that any syntactic unit that is a semantic functor of a noun can appear on that noun's ADJ list. Observe that (28) keeps the modifier-noun relationship as a functor-argument one in the semantics, even while the relationship is dependent-head in the syntax. Also, (28) is very general – it could be constrained further; for instance, to capture more fine-grained semantic relationships.

Having discussed how the adnominals appear with the noun, let me next discuss how they appear with incorporating verbs, and how the incorporating verbs are put together.

## 4.2 Analyzing Incorporating Verbs

The key analytic device of the Argument Inheritance Analysis is a descriptive lexical rule that says that for any transitive verb and semantically appropriate noun in Tongan, there can potentially be an incorporating verb, with a specific relationship to these two sources. The formal version of this rule is shown in (29):<sup>12</sup>

$$(29) \left[ \begin{array}{l} \text{RESULT} \\ \text{SOURCE} \end{array} \left[ \begin{array}{l} \text{FORM} \left\langle \boxed{1} + \boxed{2} \right\rangle \\ \text{HEAD} \textit{verb} \\ \text{VAL} \mid \text{ADJ} \left[ \boxed{B} \oplus \boxed{C} \right] \\ \text{ARG-ST} \boxed{A} \end{array} \right] \left[ \begin{array}{l} \text{FORM} \left\langle \boxed{1} \right\rangle \\ \text{HEAD} \textit{verb} \\ \text{VAL} \mid \text{ADJ} \boxed{B} \\ \text{ARG-ST} \left[ \boxed{A} \circ \left\langle \text{XP: } \boxed{3} \right\rangle \right] \\ \text{CONT} \left[ \begin{array}{l} \textit{act\_und\_rel} \\ \text{ACT} \textit{index} \\ \text{UND} \boxed{3} \end{array} \right] \end{array} \right], \left[ \begin{array}{l} \text{FORM} \left\langle \boxed{2} \right\rangle \\ \text{HEAD} \textit{noun} \\ \text{VAL} \mid \text{ADJ} \boxed{C} \\ \text{CONT} \boxed{3} \end{array} \right]$$

This lexical rule accomplishes four different things. First, it combines the FORM values of the source verb and noun. I will remain vague about precisely how this is

<sup>12</sup>The semantics are more complicated than just the linking shown here, but I will not discuss them in-depth here.

done, but I assume that the analysis would be no different that any other compound-ing construction in Tongan – incorporating verbs are head-initial, just as other compounds in the language – and that it wouldn’t be that different from compounding in other languages.

Second, (29) creates a verb, with the clausal syntax thereof. Third, it reduces the argument structure of the resulting verb, by not allowing the nominal argument functioning as the semantic undergoer to appear on the incorporating verb’s ARG-ST list.<sup>13,14</sup> This leaves one core argument on the incorporating verb’s ARG-ST list. This creates the right number of arguments for the analyses of the case-marking and relativization data discussed earlier. Fourth, the incorporating verb inherits any members of the noun’s ADJ list. Like in Malouf (1999)’s analysis, the incorporating verb not only inherits the adnominal dependents, but also inherits them in the same kind of valency function (in this case, ADJ) as they had with the noun.

### 4.3 An Example

To illustrate and further specify the elements of this analysis, let us consider an example. Given in (30) is yet another instance of the phrasal noun incorporation construction in Tongan, with an adjectival adnominal.

- (30) Na’e **kai ika lahi** ‘a Sione.  
 PAST eat fish big ABS (name)  
 ‘Sione ate big fish.’

To be accompanied by the adjectival modifier, *lahi*, ‘big,’ the noun *ika*, ‘fish,’ must have undergone the lexical rule in (28). This puts *lahi* on *ika*’s ADJ list. Then, this lexical description must have entered into the lexical rule in (29) with the verb, *kai*, ‘eat.’ This allowed *lahi* to be inherited by *kai-ika*, ‘eat-fish,’ and disallowed *kai*’s undergoer from being realized on *kai-ika*’s ARG-ST list. Finally, the argument realization principle (Manning and Sag, 1998) permitted the NP[*abs*] to be realized on the COMPS list.<sup>15</sup> This yields the lexical description given in (31):

- (31) 
$$\left[ \begin{array}{l} \text{word} \\ \text{FORM} \quad \langle \text{kai-ika} \rangle \\ \text{SYN} \quad \left[ \begin{array}{l} \text{HEAD} \quad \text{verb} \\ \text{VAL} \quad \left[ \begin{array}{l} \text{COMPS} \quad \langle \text{NP}[\textit{abs}] \rangle \\ \text{ADJ} \quad \langle \text{AP} \rangle \end{array} \right] \end{array} \right] \end{array} \right]$$

<sup>13</sup>As Runner and Aranovich (2003) suggest, this “removal” may be a consequence of the semantic mode of composition of the incorporated noun with the verb. Verifying this and making it precise I leave as open question for future research.

<sup>14</sup>This rule, though it restricts incorporation to semantic undergoers, doesn’t go quite far enough – Tongan does not allow any kind of subject to incorporate. A possible solution would be to have a constraint like LFG’s Subject Condition (Bresnan, 2001, 311) on possible verbal ARG-ST lists. Due to raising verbs, this constraint may need to apply to a verbal subtype, instead of to all verbs.

<sup>15</sup>Why this verb has no SUBJ value will be discussed below.

To put together (30), a pair of schemata will be needed. Like Dukes (2000), I will assume a flat structure for clauses in Tongan (putting aside the clause-initial TAM marker) to account for the VSO/VOS order. As far as I'm aware, there does not seem to be any evidence in Tongan for distinguishing between subjects and other grammatical relations among the non-pronominal arguments (see Dukes (1998) for an in-depth discussion of grammatical relations in Tongan). Therefore, I will not declare a SUBJ valent attribute. Instead, I will consider all verbal arguments as complements of the verb and have them combine with the verb all at once, through the *head-complements-schema*, given in (32) below:

$$(32) \left[ \begin{array}{l} \textit{head-complements-schema} \\ \text{MTR} \quad \left[ \begin{array}{l} \text{HEAD} \quad \boxed{1} \\ \text{COMPS} \quad \langle \ \ \rangle \end{array} \right] \\ \text{HD-DTR} \quad \boxed{2} \quad \left[ \begin{array}{l} \text{HEAD} \quad \boxed{1} \\ \text{VAL} \quad \left[ \begin{array}{l} \text{COMPS} \quad \boxed{A} \\ \text{ADJ} \quad \langle \ \ \rangle \end{array} \right] \end{array} \right] \\ \text{DTRS} \quad \langle \boxed{2} \rangle \circ \boxed{A} \end{array} \right]$$

As I will discuss further below, a key element of this schema is that the ADJ list of the HD-DTR is empty – this is what captures the verb-adjacent position of the adnominals. Although it is a non-standard assumption to have the adjuncts combine first (that complements combine first is usually a corollary of the fact that complements are seen to make a phrase semantically complete, while adjuncts just make a phrase a subtype of the same kind of phrase, see Dowty (2003) for a recent discussion), this part of the analysis has empirical support from the fact that all postverbal adverbs – prepositional phrase adverbials excepted – appear immediately after the verb in Tongan (Churchward, 1953, 146–149, 193–208).

To add adnominals, the incorporating verb must enter into the *head-adjunct-schema*, given below in (33).

$$(33) \left[ \begin{array}{l} \textit{head-adjunct-schema} \\ \text{MTR} \quad \left[ \begin{array}{l} \text{HEAD} \quad \boxed{1} \\ \text{ADJ} \quad \langle \ \ \rangle \end{array} \right] \\ \text{HD-DTR} \quad \boxed{2} \quad \left[ \begin{array}{l} \textit{word} \\ \text{HEAD} \quad \boxed{1} \\ \text{VAL} \mid \text{ADJ} \quad \boxed{B} \end{array} \right] \\ \text{DTRS} \quad \langle \boxed{2} \rangle \circ \boxed{B} \end{array} \right]$$

Finally, since there is no ordering constraints on the above schemata, I propose the linear precedence constraint in (34), where head daughters precede anything else within their phrases:

$$(34) \quad \text{HEAD-DTR} \prec X$$

Given Tongan’s head-initial profile, this is likely a constraint on all headed-schemata, and is just inherited by (32) and (33).

Putting together the lexical description in (31), the schemata in (32) and (33), and the constraint in (34) gives the tree in (35).

(35)

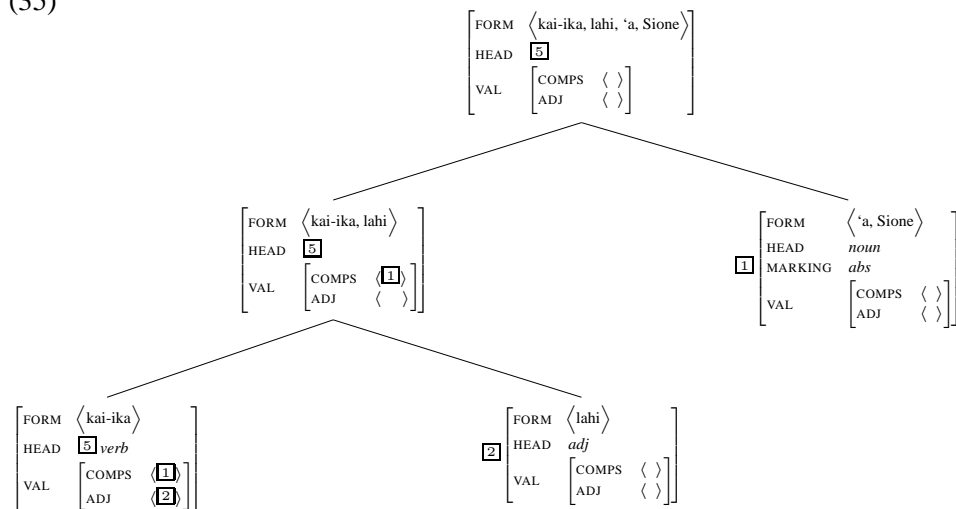

In (35),<sup>16</sup> the verb *kai-ika* and the adjective *lahi* combine to form a kind of verbal phrase via the *head-adjunct-schema*. This verbal phrase then combines with the term phrase *'a Sione* to make the top node of (35) via the *head-complements-schema*.

The interaction between the *head-complements-schema* and the *head-adjunct-schema* forces the adnominals to appear next to the verb. Reversing the order of combination would create a non-empty ADJ list in the HD-DTR of the *head-complements-schema*. This would violate the *head-complements-schema* in (32). In addition to getting the desired adjacency, this part of the analysis also allows for a straightforward analysis of the syntax of the verbal “particles.”

#### 4.4 The Syntax of “Particles”

Recall from the discussion in §2.3.2 that there is a class of adverbs I’m calling verbal “particles,” which appear after the verb in ordinary transitive clauses, and after the incorporate in the noun incorporation construction, as shown by (36).

- (36) Na'e **kai ika lahi** *nai* 'a Sione?  
 PAST eat fish big maybe ABS (name)  
 ‘Sione eats a lot of fish, doesn’t he?’ (repeats (18))

Under the Argument Inheritance Analysis, capturing the syntax of these “particles” is straightforward. If the verbal “particles” are to be analyzed as elements

<sup>16</sup>I (largely) use the framework of Sag (to appear) for (35), but, with slightly and noncrucial revisions, this tree is compatible with many different versions of HPSG.

selected via the verb’s ADJ list, the *head-adjunct-schema* (or perhaps just the specific schema that puts together incorporating verbs and modifiers) would need the linear precedence constraint in (37) to constrain the “particles” after the modifiers and the incorporating verb.

(37)  $X \prec [\text{HEAD } \textit{adverb}]$

If the “particles” are to be analyzed as being selected by the verb via the COMPS list as complements of the verb, then the *head-complements-schema* must be subject to the following LP constraint.

(38)  $[\text{HEAD } \textit{verb}] \prec [\text{HEAD } \textit{adverb}] \prec [\text{HEAD } \textit{noun}]$

It is not clear, presently, which analysis of the verbal “particles” the data support, but under either analysis of the “particles,” constraining their position is straightforward due to the configuration and dependency properties of the noun incorporation construction under the Argument Inheritance Analysis.<sup>17</sup>

#### 4.5 Further Issues

As is, the lexical rule in (29) overpredicts. First, it predicts that finite relative clauses (i.e. those not headed by *ke*) should be possible, but, in fact, finite relative clauses are impossible in noun incorporation in Tongan, as shown in (39):

(39) Finite Relative Clause  
 \*Na’e *inu kofi na’a ku ngaahi* ‘a Sione  
 PAST drink coffee PAST 1SG make ABS (name)  
 Intended: ‘Sione drank coffee that I made’

One solution to this problem is to treat the finite relative clauses as “true modifiers” and constrain them to only modify syntactically independent nouns, not parts of words. One such implementation would be to place this constraint as part of the schema that puts together the relative clause, given in (40):

(40) 
$$\left[ \begin{array}{c} \textit{finite-relative-clause-schema} \\ \text{DTRS} \left\langle \left[ \text{HEAD} \left[ \begin{array}{c} \text{FIN} + \\ \text{MOD} \left[ \text{HEAD } \textit{noun} \right] \right] \right] \right\rangle \right] \end{array} \right]$$

Since there is no syntactically independent noun present in noun incorporation, the finite relative clause can’t modify an incorporated noun.

It is possible, upon further semantic investigation, that the constraint given in (40) could be replaced or augmented by a semantic analysis that essentially says that the addition of a finite relative clause would make the semantics of the incorporate too “definite” (perhaps too individual-like) for noun incorporation. However,

<sup>17</sup>I realize this does not exhaust all the possibilities for analyzing the “particles,” but this configuration seems to work with a large number of analyses. Even under a Pollard and Sag (1994)-style MOD analysis, the analysis is straightforward: “particles” select for [HEAD *verb*] via their MOD value.

the exploration of this solution awaits future research in the semantics of the incorporation construction in Tongan.

The second problem for the lexical rule in (29) comes from the prenominal adjectives. As shown in (41), they can appear before an incorporating verb, but not as a semantic modifier of the incorporated noun.

- (41) Na'e ki'i tō manioke 'a Sione  
 PAST small plant cassava ABS (name)  
 #‘Sione planted small cassava.’  
 OK as: ‘Sione planted cassava for a short time.’

This behavior is not anomalous – as discussed by Churchward (1953, 206–207), some prenominal adjectives (including *ki'i*) can also appear before the verb in an adverbial role in ordinary transitive clauses.

However, examples like (41) raise the question of what rules out the prenominal adjectives from undergoing (29). The solution I will sketch below is a bit speculative, since it requires a more complete picture of the syntax and semantics of adjectives in Tongan, but is consistent with the current known facts.

The idea is that there is an asymmetry between pre-head and post-head “adjuncts.” Following ideas by Iida and Sells (to appear) and Toivonen (2003), a solution would be to treat *ki'i* as a word that does not project a phrase; that is, it is not underspecified for whether it is a word or phrase, but is specified to be a word. Then (29) could be restricted to allow only *phrasal* nominal adjuncts (including single words that can also serve as phrases) to be inherited by the incorporating verb, and not non-projecting words like *ki'i*.

This treatment does correspond to one independent difference between the two kinds of adjectives: postnominal (and incorporate-worthy) adjectives can appear as predicates, while prenominal (incorporate-incompatible) adjectives cannot. This is shown in (42) below:

- (42) a. 'Oku iiki 'a e talo.  
 PRES small ABS DET taro  
 ‘The taro is small.’  
 b. \*'Oku ki'i 'a e talo  
 PRES small ABS DET taro  
 Intended: ‘The taro is small.’

Given this data in (42), I think that this analysis is promising. However, further work on adjectives in Tongan is needed to decide the matter.

## 5 Conclusions

In this paper, I have shown that Tongan has a kind of “continuous stranding,” where adnominals, as syntactically separate phrases, can appear in the noun incorporation construction in Tongan and modify the morphologically-incorporated nouns. To integrate these facts into any grammatical theory, the incorporating verbs must be treated in some special fashion. The first special treatment I considered was the



Lexical Sharing Analysis. Though this analysis is straightforward in implementing the idea that the incorporating verbs belong to a “mixed” category, I have shown that this analysis is empirically inadequate. As the data from case marking and relativization show, incorporation clauses in Tongan pattern with intransitive ones, a fact that the Lexical Sharing Analysis does not capture.

I then considered a second analysis, the Argument Inheritance Analysis, which could capture the similarity of incorporation clauses with intransitive clauses, as well as offer a straightforward analysis of verbal “particles.” I then considered some of the Argument Inheritance Analysis’ present overpredictions and showed how additional constraints could be added to fix these apparent problems. However, some additional research is needed to verify the analyses suggested here.

Thus, Argument Inheritance Analysis offers a more adequate analysis of Tongan noun incorporation, and shows that the significant alterations to the HPSG architecture embedded in the Lexical Sharing Analysis are not necessary to capture the Tongan construction. Furthermore, given the success of this style of analysis for both Tongan noun incorporation and West Greenlandic denominal verbs, it remains an important analysis to consider in examining other languages purported to have stranding, since they might be amenable to a similar analysis.

## List of Abbreviations

ABS = absolutive; CAUS = causative; DEF = the definitive accent; DET = determiner; ERG = ergative; NMLZ = nominalizer; PERF = perfect; PL = plural; PRES = present; SG = singular; SBJV = subjunctive

## References

- Abeillé, Anne, Bonami, Olivier, Godard, Danièle and Tseng, Jesse. to appear. The Syntax of French *À* and *De*: An HPSG Analysis. In Patrick Saint-Dizier (ed.), *Syntax and Semantics of Prepositions*, Dordrecht: Kluwer.
- Ball, Douglas. to appear. Phrasal Incorporation in Tongan. In Jeffrey Heinz and Dimitrios Nteliheos (eds.), *Proceedings of the AFLA XII Conference, University of California, Los Angeles*, UCLA Working Papers in Linguistics.
- Bouma, Gosse, Malouf, Rob and Sag, Ivan A. 2001. Satisfying Constraints on Extraction and Adjunction. *Natural Language and Linguistic Theory* 19, 1–65.
- Bresnan, Joan. 2001. *Lexical-Functional Syntax*. Oxford: Blackwell Publishers.
- Bresnan, Joan and Mchombo, Sam A. 1995. The Lexical Integrity Principle: Evidence from Bantu. *Natural Language and Linguistic Theory* 13, 181–254.
- Chomsky, Noam. 1970. Remarks on Nominalization. In Roderick A. Jacobs and Peter S. Rosenbaum (eds.), *Readings on English Transformational Grammar*, pages 184–221, Waltham, Massachusetts: Ginn.

- Chung, Sandra and Ladusaw, William A. 2004. *Restriction and Saturation*. Cambridge, Massachusetts: MIT Press.
- Churchward, C. Maxwell. 1953. *Tongan Grammar*. London: Oxford University Press.
- Churchward, C. Maxwell. 1959. *Tongan Dictionary*. London: Oxford University Press.
- Dixon, R.M.W. and Aikhenvald, Alexandra Y. 2002. Word: a typological framework. In R.M.W. Dixon and Alexandra Y. Aikhenvald (eds.), *Word: A cross-linguistic typology*, pages 1–41, Cambridge: Cambridge University Press.
- Dowty, David. 2003. The Dual Analysis of Complements/Adjuncts in Categorical Grammar. In Ewald Lang, Claudia Maienborn and Cathrine Fabricius-Hansen (eds.), *Modifying Adjuncts*, Berlin: Mouton de Gruyter.
- Dukes, Michael. 1998. Evidence for Grammatical Functions in Tongan. In Miriam Butt and Tracy Holloway King (eds.), *Proceedings of the LFG98 Conference (Workshop on Voice and Grammatical Functions in Austronesian)*, CSLI Publications, <http://www.sultry.arts.usyd.edu.au/LFG98/austro/workshop.htm>.
- Dukes, Michael. 2000. The Morphosyntax of 2P Pronouns in Tongan. In Dan Flickinger and Andreas Kathol (eds.), *Proceedings of HPSG-2000 Conference*, pages 63–80, CSLI Publications, <http://csli-publications.stanford.edu/HPSG/1/>.
- Gerds, Donna B. 1998. Incorporation. In Andrew Spencer and Arnold M. Zwicky (eds.), *The Handbook of Morphology*, pages 84–100, Oxford: Blackwell.
- Iida, Masayo and Sells, Peter. to appear. Mismatches between Morphology and Syntax in Japanese Complex Predicates. In Wilhelm Geuder, Irina Nikolaeva and Andrew Spencer (eds.), *Mixed Categories and Morpho-Syntactic Mismatches*, Berlin and New York: Mouton de Gruyter.
- Kathol, Andreas. 2000. *Linear Syntax*. Oxford: Oxford University Press.
- Kim, Jong-Bok and Sells, Peter. this volume. Copy Constructions and their Interaction with the Copula in Korean.
- Kim, Jong-Bok, Sells, Peter and Wescoat, Michael T. 2004. Korean Copular Constructions: A Lexical Sharing Approach. In M. Endo Hudson, Sun-Ah Jun and Peter Sells (eds.), *Proceedings of the 13th Japanese/Korean Linguistics Conference*, Stanford, California: CSLI Publications.
- Malouf, Robert. 1999. West Greenlandic Noun Incorporation in a Monohierarchical Theory of Grammar. In Gert Webelhuth, Jean-Pierre Koenig and Andreas Kathol (eds.), *Lexical and Constructional Aspects of Linguistic Explanation*, pages 47–62, Stanford, California: CSLI Publications.
- Manning, Christopher D. and Sag, Ivan A. 1998. Argument Structure, Valence, and Binding. *Nordic Journal of Linguistics* 21, 107–144.

- Massam, Diane. 2001. Pseudo Noun Incorporation in Niuean. *Natural Language and Linguistic Theory* 19, 153–197.
- Mithun, Marianne. 1984. The Evolution of Noun Incorporation. *Language* 60, 847–894.
- Otsuka, Yuko. 2005. Syntax and/or Pragmatics: PP Scrambling and the Thematic Hierarchy, handout, AFLA XII, University of California-Los Angeles.
- Pollard, Carl J. and Sag, Ivan A. 1987. *Information-Based Syntax and Semantics*. CSLI Lecture Notes No. 13, Stanford, California: CSLI Publications.
- Pollard, Carl J. and Sag, Ivan A. 1994. *Head-driven Phrase Structure Grammar*. Chicago: University of Chicago Press.
- Przepiórkowski, Adam. 1999. On Case Assignment and “Adjuncts as Complements”. In Gert Webelhuth, Jean-Pierre Koenig and Andreas Kathol (eds.), *Lexical and Constructional Aspects of Linguistic Explanation*, pages 231–245, Stanford, California: CSLI Publications.
- Rosen, Sara Thomas. 1989. Two Types of Noun Incorporation: A Lexical Analysis. *Language* 65, 294–317.
- Runner, Jeffrey T. and Aranovich, Raúl. 2003. Noun Incorporation and Rule Interaction in the Lexicon. In Stefan Müller (ed.), *Proceedings of the HPSG-2003 Conference, Michigan State University, East Lansing*, pages 359–379, CSLI Publications, <http://csli-publications.stanford.edu/HPSG/4/>.
- Sag, Ivan A. this volume. Adverb Extraction: a defense of tracelessness.
- Sag, Ivan A. to appear. Remarks on Locality, manuscript, Stanford University. To appear in *Ohio State Working Papers in Linguistics*.
- Sag, Ivan A., Wasow, Thomas and Bender, Emily M. 2003. *Syntactic Theory: A Formal Introduction*. Stanford, California: CSLI Publications, second edition.
- Toivonen, Ida. 2003. *Non-Projecting Words: A Case Study of Swedish Verbal Particles*. Dordrecht: Kluwer.
- Wescoat, Michael T. 2002. *On Lexical Sharing*. Ph. D. thesis, Stanford University.

# Towards a semantic analysis of argument/oblique alternations in HPSG

John Beavers 

CSLI, Stanford University

Proceedings of the 12th International Conference on  
Head-Driven Phrase Structure Grammar

Department of Informatics, University of Lisbon

Stefan Müller (Editor)

2005

Stanford, CA: CSLI Publications

pages 28–48

Beavers, John. 2005. Towards a semantic analysis of argument/oblique alternations in HPSG. In Stefan Müller (ed.), *Proceedings of the 12th International Conference on Head-Driven Phrase Structure Grammar, Department of Informatics, University of Lisbon*, 28–48. Stanford, CA: CSLI Publications. DOI: 10.21248/hpsg.2005.2.



## Abstract

I examine the semantic contrasts exhibited by argument/oblique alternations (argument realization alternations where one or more participants may be realized either as a direct argument or an oblique). Previous HPSG accounts of these have proposed that alternating verbs are ambiguous, where each variant has a structured semantics that makes different participants more or less structurally prominent in the semantic representation. I argue that such accounts fail to capture the full richness of the contrasts exhibited by such alternations, and propose instead a model that derives alternations from the lexical entailments each verb associates with the alternating participant.

## 1 Introduction

In this paper I outline a semantic analysis of what I refer to as argument/oblique alternations, in which a verb selects for one or more participants that may be realized either as a direct argument or as an oblique (Levin 1993). Following Beavers (to appear b), I argue that when such alternations exhibit semantic contrasts it is always in terms of the relative number of entailments associated with the alternating participant and I sketch a framework for capturing this in HPSG.<sup>1</sup> I use as my primary case study the locative alternation (Fillmore 1968), as exemplified in (1).

- (1) a. John loaded the hay onto the wagon. (locatum=DO, location=oblique)  
b. John loaded the wagon with the hay. (location=DO, locatum=oblique)

In (1a) the locatum (the thing moved) is realized as the direct object and in (1b) it is realized as an oblique marked by *with*. Conversely, in (1a) the location is realized as an oblique but as the direct object in (1b). Many semantic properties associated with each participant are **invariant** across both variants, e.g. one participant is always a location that comes to contain the locatum, while the other is always a locatum that comes to rest in or on the location. However, the classic observation (see Anderson 1971) is that whichever participant is realized as the direct object receives a “holistically affected” interpretation (all moved or loaded up):

- (2) a. John loaded the hay onto the wagon, but left some space for the grain.  
b. #John loaded the wagon with the hay, but left some space for the grain.  
(3) a. John loaded the wagon with the hay, but left some to fill the truck.  
b. #John loaded the hay onto the wagon, but left some to fill the truck.

---

<sup>†</sup>I would like to acknowledge the support of NTT and the LinGO project at CSLI in the development of this work. I would also like to thank Doug Ball, Dan Flickinger, Valia Kordoni, Beth Levin, Carl Pollard, Mika Poss, Ivan Sag, and three anonymous reviewers for their comments.

<sup>1</sup>This is part of a larger study based on a theory of thematic roles as sets of entailments, following Dowty (1991). I use “entailment” in the sense of Dowty’s (1989) “lexical entailment”, i.e. properties a verb ascribes to an entity due to its role in the event. See Beavers (to appear b) for more details on the English data motivating this analysis and previous semantic work on alternations.

In (2b) and (3b) the direct object realizations of both participants are infelicitous in contexts in which holistic affectedness does not obtain for that participant. In (2a) and (3a), however, the oblique realizations are compatible with contexts in which holistic affectedness does not obtain (and those in which it does). Thus the oblique realizations are **underspecified** for holistic affectedness: it is neither entailed nor contradicted. Although the locative alternation and holistic affectedness have been discussed extensively in previous literature (usually with respect to the verbs *load* and *spray*), other verbs not normally considered to be locative alternating verbs participate in a morphosyntactically similar paradigm with a related but distinct semantic contrast, as shown in (4) for the verb *cut*.

- (4) a. John cut his hand on the rock. (hand affected; rock not necessarily)  
 b. John cut the rock with his hand. (rock affected; hand not necessarily)

Again there are locatum and location participants which appear to alternate between direct object and oblique realization, and again there is a semantic contrast having to do with affectedness. However, here the contrast is in simple affectedness: in both cases the direct objects are affected in some way, while the corresponding obliques are not necessarily affected at all. There is no sense in which “holistic” affectedness plays a role. However, the morphosyntactic similarities suggest that (1) and (4) may be two manifestations of the same alternation, as does the fact that both alternations involve underspecification of the degree of affectedness (similar points are also made by Fillmore 1977, Gawron 1986, and Dowty 1991).

We also see underspecificity contrasts in the dative alternation. Ditransitive verbs are subcategorized for an agent, a theme, and a goal/recipient that may be realized either as a first object or as a *to*-oblique. In both variants the goal/recipient is invariably a (physical or abstract) goal of the “motion” of the theme, but when it is a first object it carries the additional semantics of coming to possess the theme (Pesetsky 1995, Harley 2003). This is illustrated in (5), where an inanimate first object is infelicitous unless construed of as being somehow capable of possession.

- (5) a. John sent a letter to London. (Location or “London Office” reading)  
 b. John sent London a letter. (Only “London Office” reading).

The oblique variant is underspecified for possession (cf. (5a) is compatible with both a “London office” and a locational London reading) but the first object variant requires it (forcing a “London office” reading), while both variants invariably involve a goal of some sort (in both cases London corresponds to the endpoint of the movement of the letter). Similar underspecificity relationships in fact hold for numerous other alternations, including those in (6)-(12) (Beavers to appear b).

- (6) **Reciprocal alternation** (Underspecified motion)  
 a. The car and the truck collided. (car and truck in motion)  
 b. The car collided with the truck. (car in motion; truck not necessarily)

- (7) **Conative alternation I** (Underspecified holistic affectedness)  
 a. John ate the sandwich. (sandwich all eaten)  
 b. John ate at the sandwich. (sandwich not necessarily all eaten)
- (8) **Conative alternation II** (Underspecified affectedness)  
 a. John slashed the canvas. (canvas affected)  
 b. John slashed at the canvas. (canvas possibly not affected)
- (9) **Dative alternation w/Ballistic Motion** (Underspecified possession/goal)  
 a. John threw Mary the ball. (Mary a goal and possessor)  
 b. John threw the ball to Mary. (Mary not necessarily possessor)  
 c. John threw the ball at Mary. (Mary not necessarily goal or possessor)
- (10) **Preposition drop alternation** (Underspecified holistic traversal)  
 a. John climbed the mountain. (entire mountain traversed)  
 b. John climbed up the mountain. (mountain possibly not all traversed)
- (11) **Search alternation I** (Underspecified existence)  
 a. John hunted a unicorn in the woods. (unicorn presupposed to exist)  
 b. John hunted (in) the woods for a unicorn. (unicorn might not exist)
- (12) **Search alternation II** (Underspecified holistic coverage)  
 a. John searched the woods for deer. (woods totally searched)  
 b. John searched in the woods for deer. (woods maybe not all searched)

In each case the direct argument is specified for a semantic property left underspecified for the corresponding oblique, where the exact semantic contrast varies but includes motion, affectedness, possession, total traversal, etc. Thus an adequate analysis of alternations must capture the following generalization:

- (13) Direct argument variants entail more about the alternating participant than oblique variants.

Furthermore, the exact contrasts are simultaneously verb, verb-class, and alternation specific. For example, for all “locative” alternations the underspecified property is the degree of affectedness. But the exact degree of affectedness varies, and verbs cluster into classes. For *load* (also *spray* and *smear*) the contrast has to do with holistic affectedness, while for *cut* it has to do with simple affectedness. Finally, within a class, each verb associates different entailments with different variants. When the location participant of *spray* is the direct object it is specified for total surface area coverage by the locatum, whereas when the location participant of *load* is the direct object it is specified for having reached maximum containment (e.g. all filled up with the locatum). Ideally a theory of alternations should capture (13) in a way that admits lexical and alternation specific idiosyncrasy.

## 2 Previous HPSG Approaches

Previous HPSG analyses have generally failed to capture (13), typically by not providing a rich enough semantics to capture the contrasts. I focus here on the work of Davis and Koenig (Davis and Koenig 2000, Davis 2001, Koenig and Davis 2003, 2004), by far the most influential work on argument realization in HPSG. One of the key motivations for Davis and Koenig’s theory is the elimination of unnecessary and independently unmotivated constructs (such as thematic role hierarchies and complex predicate decompositions) in favor of the simplest possible link between lexical semantics and argument realization (see Davis 2001:25ff). In principle, such a theory involves only argument structure on the one hand and verb-specific entailments constituting the verb’s lexical semantics on the other, where the entailments determine how each participant is realized in the argument structure. Davis and Koenig (2000) and Davis (2001), however, argue that to capture certain generalizations an intermediate level of semantic representation is necessary, namely predicate decompositions that encode reified proto-roles in the Dowty (1991) sense. I do not focus here on their specific arguments for a tripartite linking theory, but instead on their analysis of the locative alternation to show that it does not provide a direct way of capturing the subtle contrasts argued for above.<sup>2</sup>

Following the predicate decomposition approaches of Levin and Rappaport (1988) and Pinker (1989) (among others), Koenig and Davis (2004) assume that locative alternating verbs are polysemous between a change of location reading (where the locatum comes to be moved) and a change of state by means of a change of location reading (where the location changes state because the locatum is moved into some configuration with it). They encode this via two lexical entries for each verb, as shown in (14) for *spray* (cf. Koenig and Davis 2004:30, Fig. 25).

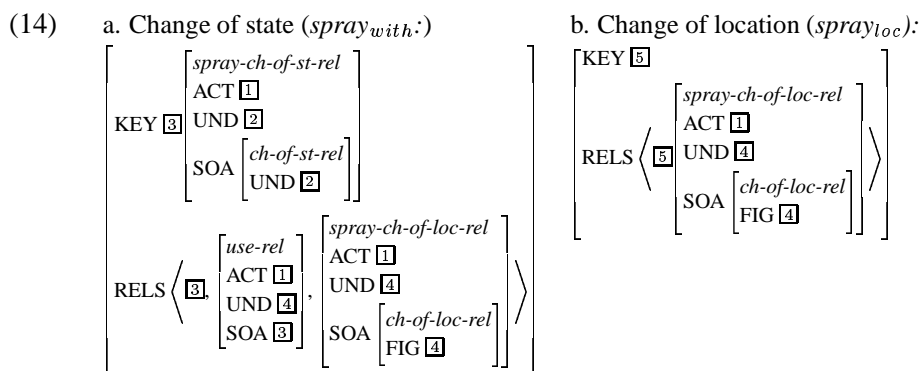

<sup>2</sup>Davis and Koenig (2000) and Davis (2001) bring up several arguments against purely entailment based linking theories, focusing almost entirely on Dowty (1991). They argue against such a theory based primarily on the fact that (a) some entailments, such as those having to do with causation, can outrank or trump others in subject selection, (b) there exist certain counterexamples to Dowty’s proposed proto-role entailments, and (c) Dowty’s theory only addresses transitive verbs. However, most of their criticisms are specific to Dowty’s proposal and do not necessarily constitute general arguments against a sufficiently fleshed out entailment based theory. This paper and Beavers (to appear b), in fact, specifically address point (c) in such a theory.



Each entry has a different *elementary-predication* (EP) from its REL(ATION)S list as its KEY value, representing the two possible meanings associated with such verbs. In (14a) the *spray-ch(ange)-of-st(ate)-rel* is the KEY value, whereas in (14b) it is the *spray-ch-of-loc-rel*. The different KEY choices mean that different participants are linked to the KEY.UND(ERGOER) attributes: in (14a) the location is the KEY.UND, while in (14b) it is the locatum. On Koenig and Davis’s approach, KEY.UND is always linked to the direct object on ARG-ST, meaning that each variant realizes a different participant as the direct object, thus capturing the alternation.<sup>3</sup> However, this approach so far fails to capture the semantic contrast since no entailment of holistic affectedness (or its absence) is encoded anywhere in (14).

In earlier work Davis and Koenig (2000) and Davis (2001) argue that the UND attribute is associated with various verb-specific “characteristic entailments”, roughly corresponding to Dowty’s (1991) proto-patient entailments (e.g. “incremental theme”). On this approach the presence of at least one such entailment is in fact a necessary condition for the presence of the UND attribute in the CONT value of the verb (e.g. Davis’s 2001:81 “attribute-to-entailment condition”). If such entailments underlie KEY.UND, we could simply stipulate that KEY.UND must be associated with characteristic entailments that are underspecified for other patientive attributes, thus capturing (13) (cf. a related, non-MRS analysis of alternations in causee realization in Spanish in Davis 2001, where linking to an UND feature at the highest level of decomposition corresponds to how affected the causee is).

However, this approach presents several problems. First and foremost, it fails to explain in a general way which entailments vary for each verb, verb class, or alternation. For example, it does not explain which entailments are associated with KEY.UND for *spray* vs. *load* vs. *cut*. Furthermore, it fails to explain which entailments are appropriate for different alternations (e.g. affectedness for conative and locative alternations, traversal for preposition drop alternations, etc.). The specificity condition on KEY.UND thus needs to be indexed to both the verb and alternation. Second, this approach fails to capture non-undergoer alternations. In the dative alternation the alternating participant is not necessarily linked to UND (Kordoni 2004 posits an additional macrorole) and in the reciprocal alternation in (6) there is not necessarily an UND attribute at all. Thus more KEY-based conditions must be stipulated for other attributes that mirror the one posited for UND. Third, this analysis involves considerable polysemy, something that is undesirable if it can be avoided, especially since the different variants in each alternation appear to share a considerable amount of invariant semantics despite the contrasts.

Although a key motivation for Davis and Koenig’s analysis is the elimination of unnecessary semantic constructs, their approach still relies on a mediating level of structure between entailments and argument structure. While none of the problems

---

<sup>3</sup>See Kordoni (2002) for related HPSG work on Greek, Davis (2001:135-140) for a non-MRS version of the same analysis, and Van Valin (2002) for a similar approach in Role and Reference Grammar. Note that *use-rel* and *spray-ch-of-state-rel*, present in the *spray<sub>with</sub>* variant, are absent from the *spray<sub>loc</sub>* variant, although these presumably are invariant across both uses of *spray* and should be present in both AVMs.

discussed here are insurmountable, they suggest that this level of structure does not provide the most natural way to capture the contrasts discussed above. Instead, we want to be able to state constraints directly on the lexical entailments.<sup>4</sup> Once we allow this, it may then even be possible to eliminate the intermediate semantic structure. I outline such a theory in the next section.<sup>5</sup>

### 3 A Purely Entailment Based Approach

I encode (13) in terms of a theory of thematic roles as sets of entailments as in Dowty (1989, 1991). I define first an **individual thematic role** (following the terminology of Dowty 1989:76), which is the set of entailments that constitutes the role a verb assigns to one of its participants:

- (15) For verb  $V$  describing situation  $s$ , the role participant  $x$  plays in  $s$  is a set of  $V$ -specific entailments  $R$ , which is  $x$ 's **individual thematic role**.

Thus the individual thematic role  $R$  of some participant  $x$  is the set of all things, from the very general to the quite specific, that  $V$  says about  $x$ 's role in  $s$ . Such thematic roles are quite rich in information. Two such roles are illustrated in (16) for the locatum participants of *load* and *spray* respectively.

(16)

	V-Specific	More General	Most General
LOCATUM <sub>load</sub>	{ $x$ loaded onto sth, ..., }	$x$ is moved, ...,	$x$ is affected, ..., }
LOCATUM <sub>spray</sub>	{ $x$ sprayed out of sth, ..., }	$x$ is moved, ...,	$x$ is affected, ..., }

At a very verb-specific level, these two locatum participants have idiosyncratic semantics associated with them that make them unique from one another, e.g. the locatum of *load* is loaded onto something while the locatum of *spray* is sprayed out of something onto something else. At a more general level, each of these participants is moved somewhere, an entailment that they share in common, and in fact the two more specific entailments of being moved onto or out of something imply this. Still more generally, we can say that in some way each participant is therefore affected somehow, i.e. changes its condition (in this case its position), an entailment again both share in common and one that is again implied by the more specific entailments. Thus individual thematic roles have two properties relevant here: (a) they contain very verb-specific entailments that differentiate them but also share quite a lot of more general entailments, and (b) the entailments within each role are at least partly structured in terms of implicational relationships.

Some (though not all) individual thematic roles can be related to one another in terms of what I refer to as **specificity**:

<sup>4</sup>Even if one replaces UND with attributes directly representing the characteristic entailments (as in Koenig and Davis 2003, e.g. positing an INCREMENTAL-THEME feature), this approach still fails to capture the variable behavior of the same alternation with different verbs.

<sup>5</sup>See Beavers (to appear b) for further discussion of why predicate decompositions as in Levin and Rappaport (Hovav) (1988, 1998), Pinker (1989), Jackendoff (1990), Davis (2001), *inter alia* are ill-suited to capture (13). See Koenig and Davis (2004) for a general critique of such approaches.

(17) For individual thematic roles  $R$  and  $Q$ ,  $R$  is more **specific** than  $Q$  if  $Q \subset R$ .

Role  $R$  is more specific than  $Q$  if  $R$  contains all the entailments of  $Q$  plus at least one more. Not all individual thematic roles stand in a specificity relationship (e.g. the two locatum roles in (16) do not), but once we define thematic roles as sets of entailments it is possible that some roles will stand in specificity relationships to one another. On the basis of (17), we can reformulate (13) as in (18).

(18) **Morphosyntactic Alignment Principle (MAP):** When participant  $x$  may be realized as either a direct or oblique argument of verb  $V$ , it bears role  $R$  as a direct argument and role  $Q$  as an oblique where  $Q \subset R$ .

Thus we now have a more explicit framework for capturing the underspecificity contrasts exhibited by argument/oblique alternations. However, this reformulation does not predict *which* roles  $x$  will bear for a given alternation and verb  $V$ . To make predictions about this we need a more limited and general notion of possible contrasts to which we can tie the MAP. Following Dowty (1989), I assume that broad argument-marking patterns such as argument/oblique contrasts are based on a more general kind of role called a **thematic role type** (where the term “type” here is not related to the HPSG notion of “type”):

(19) A **thematic role type** is a set of entailments shared across individual thematic roles.

A thematic role type is an intersection of individual thematic roles that serves to cross-classify individual thematic roles by means of shared entailments. Of course, there are numerous thematic role types (any intersection of any individual thematic roles is a thematic role type). As Dowty (1989) argues, only some thematic role types are linguistically interesting for describing generalizations about argument realization. The set of linguistically relevant thematic role types Dowty refers to as **L-thematic roles**. Exactly which thematic role types are L-thematic roles is not a question I intended to address here, but presumably these are very general thematic role types involving general entailments having to do with causation, affectedness, possession, etc., at the level of generality of the most general entailments in (16). For object alternations such as the locative alternation I propose the following L-thematic roles are relevant for capturing the appropriate generalizations, based only on a very general notion of “affectedness” that subsumes being changed, moved, created, destroyed, searched, or covered, i.e. different ways something can be dynamically acted upon (Beavers to appear b).

(20)	L-Thematic Roles	Informal Definition	Example Individual Thematic Roles
	TOTALLY AFFECTED	Affected to a specific degree	Completely loaded or moved entity ( $DO_{load}$ )
	AFFECTED	Affected to a non-specific degree	Loaded, moved entity ( $oblique_{load}$ ), or cut entity ( $DO_{cut}$ )
	PARTICIPANT	Unspecified for affectedness	Entity not known to be affected ( $oblique_{cut}$ )

Something is **TOTALLY AFFECTED** if its individual thematic role includes entailments involving being affected (e.g. moved or changed) to some particular degree (e.g. “holistically”) such as the roles of the location and locatum direct objects in (1). Something is **AFFECTED** if its individual thematic role contains entailments involving being changed, moved, created, etc., though not necessarily to a specific degree, as for instance the direct object of *cut* (which may be a little or a lot cut in the course of a cutting event). Finally, something is a **PARTICIPANT** if no particular affectedness is known at all, such as the oblique arguments of *cut* above.<sup>6</sup> The exact form of these L-thematic roles is not relevant here, although we could assume for now that they can be defined as in (22) in terms of two general entailments that form an implicational relationship as in (21).

(21)  $\iota d.x$  is affected to  $d$  degree  $\Rightarrow \exists d.x$  is affected to  $d$  degree

(22) 

TOTALLY AFFECTED		AFFECTED		PARTICIPANT
$\left\{ \begin{array}{l} \iota d.x \text{ is affected to } d \text{ degree} \\ \exists d.x \text{ is affected to } d \text{ degree} \end{array} \right\}$	$\supset$	$\left\{ \exists d.x \text{ is affected to } d \text{ degree} \right\}$	$\supset$	$\left\{ \right\}$

**TOTALLY AFFECTED** and **AFFECTED** share the entailment that there exist some degree to which the participant is affected, and **TOTALLY AFFECTED** additionally carries an entailment that the degree of affectedness is unique. **PARTICIPANT** is the empty role. Just like individual thematic roles, thematic role types also form specificity hierarchies as demonstrated by the subset relations in (22). The alternations of individual thematic roles in (1) and (4) (and other alternations) can thus be described as **minimal specificity contrasts in thematic role types** along (22):<sup>7</sup>

(23) 

General Contrast	:	TOTALLY AFFECTED		AFFECTED		PARTICIPANT
<i>load/spray</i>	:	DO	$\rightarrow$	OBL		
<i>cut/break</i>	:			DO	$\rightarrow$	OBL

In essence this represents a kind of relativized harmonic alignment of thematic roles to markedness, where the hierarchy in (22) represents a natural prominence hierarchy of thematic role types based on specificity/implication, and realization options are aligned along this hierarchy in terms of their relative markedness, where the less marked options (direct argument realizations) are aligned to the most prominent L-thematic role in the hierarchy and the more marked options (oblique realizations) align to the next most specific role (see Aissen 2003 on Silverstein 1976-style animacy and definiteness hierarchies in differential object marking; see Fillmore 1977 for more general discussion of prominence scales in argument realization). The notion of minimal specificity contrasts in L-thematic roles can be characterized set-theoretically via a function *min* from individual thematic roles to individual thematic roles as in (24), by which we can reformulate (18) as in (25).

<sup>6</sup>All of these concepts can be defined more precisely in the scalar approach to dynamic predicates in Beavers (to appear a). (cf. Hay et al. 1999) in terms of constraints dynamic predicates do or do not place on the scales that measure out the temporal structure of the event. In Hay et al. (1999) terms, total affectedness corresponds to quantized change and affectedness to non-quantized change.

<sup>7</sup>Presumably the most specific L-thematic role corresponds to Dowty’s (1991) proto-patient role as proposed in Beavers (to appear b), though I do not discuss this further here.

- (24) For L-thematic roles  $\tau_1$  and  $\tau_2$ ,  $\tau_1 \supset \tau_2$ , forming a minimal specificity contrast, and for individual thematic role  $R$  of type  $\tau_1$ , the role  $Q = \text{min}(R)$  is the maximal subset of  $R$  of type  $\tau_2$ .
- (25) **MAP (Revised):** When participant  $x$  may be realized as either a direct or oblique argument of verb  $V$ , it bears role  $R$  as a direct argument and role  $\text{min}(R)$  as an oblique.

For example, *the wagon* as a direct object in (1) has individual thematic role of type TOTALLY AFFECTED but an individual thematic role of type AFFECTED as an oblique, which contains all of the same entailments except those that would make its thematic role type TOTALLY AFFECTED. This is outlined in (26).

- (26) a. loaded the wagon with the hay      b. loaded the hay onto the wagon
- |  |  |
|--|--|
| $\left\{ \begin{array}{l} \mathbf{\text{all of } x \text{ is all filled up}} \\ \mathbf{\exists d.x \text{ is affected to } d \text{ degree}} \\ \dots \\ x \text{ is loaded} \\ \exists d.x \text{ is affected to } d \text{ degree} \\ \dots \\ x \text{ is a locational goal} \end{array} \right\}$ | $\left\{ \begin{array}{l} x \text{ is loaded} \\ \exists d.x \text{ is affected to } d \text{ degree} \\ \dots \\ x \text{ is a locational goal} \end{array} \right\}$ |
|--|--|

In (26a) the role assigned to the location participant involves numerous entailments of varying generality. This role has thematic role type TOTALLY AFFECTED since it contains all of the entailments of that role. The ones in boldface are those that are unique to the TOTALLY AFFECTED role or else imply the entailments that are unique to it. In the corresponding role in (26b) the only remaining entailments are those that are not unique to the TOTALLY AFFECTED type or do not imply such entailments, i.e. the boldfaced ones from (26a). What is left are entailments that include being affected to a non-specific degree and invariant entailments not part of the relevant L-thematic roles (e.g. being a location). This individual thematic role is of type AFFECTED but not type TOTALLY AFFECTED since it lacks the crucial entailment of being affected to a specific degree. Thus the individual thematic role contrast in (26) is keyed to L-thematic roles in a way that generates a cascade effect: verb-specific entailments that imply the more general ones (due to the implicational relationships between entailments) are also underspecified. In this manner, verb, verb class, and alternation specific contrasts are intrinsically captured since contrasts at one level of generality force contrasts at others.

## 4 Encoding in HPSG

I encode (25) as constraints on  $v\text{-}lxm$ , which I present in two parts: the constraints on linking direct arguments, and those for linking obliques. I first assume a feature ROLES in each verb's CONT value (assuming the MRS semantics of Copetake et al. 2003 but ignoring scoping-related features here):

$$(27) \text{ roles-mrs} \Rightarrow \text{mrs} \ \& \ \left[ \text{ROLES} \langle \text{set}(\text{entailments}) \rangle \right]$$

The type *roles-mrs* is the type of the CONT(ENT) value of verb lexemes (and, as we will see below, preposition lexemes), and the ROLES feature defines the list of roles a head assigns to its *direct* arguments. Role assignment is done via EPs of type *role-rel* on the head's RELS list:

$$(28) \quad \textit{role-rel} \Rightarrow \textit{elementary-predication} \ \& \ \left[ \begin{array}{l} \text{ARG1 } i \\ \text{ROLE } \textit{set}(\textit{entailments}(i)) \end{array} \right]$$

Assigning roles to the direct arguments of verbs is done by associating each NP argument directly with a role on the verb's ROLES list:<sup>8</sup>

$$(29) \quad \textit{Direct argument linking: } v\text{-}lxm \Rightarrow \left[ \begin{array}{l} \text{ARG-ST } \langle \text{NP}_{i_1}, \dots, \text{NP}_{i_n} \rangle \circ \textit{list}(\textit{non-NP}) \\ \text{CONT } \left[ \begin{array}{l} \text{ROLES } \langle \boxed{R_1}, \dots, \boxed{R_n} \rangle \circ \textit{list} \\ \text{RELS } \left\langle \left[ \begin{array}{l} \textit{role-rel} \\ \text{ARG1 } i_1 \\ \text{ROLE } \boxed{R_1} \end{array} \right], \dots, \left[ \begin{array}{l} \textit{role-rel} \\ \text{ARG1 } i_n \\ \text{ROLE } \boxed{R_n} \end{array} \right] \right\rangle \circ \textit{list} \end{array} \right]$$

Thus, each NP argument of any verb (but not non-NP arguments) is assigned some role from the verb's ROLES list, although not every role is necessarily assigned to some NP argument. Assigning roles to PP arguments of the verb is more complicated. As discussed in the previous section, ideally the role assigned to any PP argument is the output of *min* for some unassigned role on the ROLES list, i.e. a role that is minimally contrastive in terms of L-thematic roles to the role that a corresponding direct argument could be assigned.<sup>9</sup>

$$(30) \quad \textit{Oblique linking (preliminary): } v\text{-}lxm \Rightarrow \left[ \begin{array}{l} \text{ARG-ST } \langle \text{PP}_{j_1}, \dots, \text{PP}_{j_m} \rangle \circ \textit{list}(\textit{non-PP}) \\ \text{CONT } \left[ \begin{array}{l} \text{ROLES } \langle \boxed{Q_1}, \dots, \boxed{Q_m} \rangle \circ \textit{list} \\ \text{RELS } \left\langle \left[ \begin{array}{l} \textit{role-rel} \\ \text{ARG1 } j_1 \\ \text{ROLE } \textit{min}(\boxed{Q_1}) \end{array} \right], \dots, \left[ \begin{array}{l} \textit{role-rel} \\ \text{ARG1 } j_m \\ \text{ROLE } \textit{min}(\boxed{Q_m}) \end{array} \right] \right\rangle \circ \textit{list} \end{array} \right]$$

However, in addition to assuming that each oblique argument receives a minimally contrastive role, we also want to restrict which oblique markers occur for which arguments, i.e. be sure that not any PP can receive any role. To constrain

<sup>8</sup>For the remainder of the paper I ignore irrelevant features such as SS and LOC in the paths to the features of interest. The constraints I propose here are English specific. For a language with more elaborate case morphology we would need to distinguish not just between NPs and non-NPs but also between NPs marked with structural case and NPs marked with inherent (oblique) case, presumably in terms of a CASE feature. Note that these constraints are defaults; a particular verb can override the general linking if for instance it idiosyncratically selects a particular oblique marker.

<sup>9</sup>The constraints in (29) and (30) are presented separately only for presentational purposes. These are intended to be read together and the coidentification tags (the  $\boxed{R}$ s and  $\boxed{Q}$ s) are meant to be unique.

which obliques can bear which roles, I assume that oblique markers are semantically contentful and also have CONT values of type *roles-mrs*, contributing individual thematic roles that must be compatible with the role assigned by the verb, following in particular Gawron (1986) (see also Markantonatou and Sadler 1995, Wechsler 1995, and Davis 2001; see Pesetsky 1995:133 on “mediated  $\theta$ -selection”). For example, the PPs relevant for (1) are given in (31), where the individual thematic roles supplied by each preposition represent their inherent semantics.

$$(31) \quad \text{a.} \quad \left[ \begin{array}{l} \text{ORTH} \langle \textit{onto, the, wagon} \rangle \\ \text{CONT} \left[ \begin{array}{l} \text{ROLES} \langle \text{LOCATION}_{\textit{goal}} \rangle \\ \text{RELS} \langle \left[ \begin{array}{l} \textit{wagon-rel} \\ \text{ARG1 } i \end{array} \right], \dots \rangle \end{array} \right] \end{array} \right] \quad \text{b.} \quad \left[ \begin{array}{l} \text{ORTH} \langle \textit{with, the, hay} \rangle \\ \text{CONT} \left[ \begin{array}{l} \text{ROLES} \langle \text{CAUSALLY-INTERM.} \rangle \\ \text{RELS} \langle \left[ \begin{array}{l} \textit{hay-rel} \\ \text{ARG1 } i \end{array} \right], \dots \rangle \end{array} \right] \end{array} \right]$$

In each case the individual thematic role is rather general in nature, just specifying some basic conditions that its complement must satisfy. The role  $\text{LOCATION}_{\textit{goal}}$  simply defines a participant as a locational goal, i.e. a location of some sort (potentially abstract) to which some participant arrives.<sup>10</sup> Following Croft (1991:178), *with* assigns a role CAUSALLY-INTERMEDIATE, i.e. an entity that is intermediate in the event’s force-dynamic structure, as illustrated in the (simplified) Croft-style force-dynamic diagram in (32).

$$(32) \quad \begin{array}{ccccccc} \textit{John} & & \textit{hay} & & \textit{wagon} & & \text{(Participants)} \\ \bullet & \longrightarrow & \bullet & \longrightarrow & \bullet & & \text{(Force dynamic chain)} \end{array}$$

In other words, in a loading event John acts forcibly on the hay, and then this force is transmitted to the wagon, which becomes loaded with the hay. This very general thematic role in fact covers both the instrumental and locatum uses of *with* (cf. Levin and Rappaport 1988 on *with* as a “displaced theme” marker). To ensure compatibility between the individual thematic role licensed by the verb and the individual thematic role licensed by the preposition, I assume that the latter must be a superset of the former (similar to Gawron’s assumption that oblique arguments contribute semantics already determined by the verb):

$$(33) \quad \begin{array}{ccccc} \text{Role}_{\textit{Prep}} & & \text{Actual Role} & & \text{Role}_V \\ P & \subseteq & \textit{min}(Q) & \subset & Q \end{array}$$

That is, the actual role of the participant is a superset of what is contributed by the preposition but is a subset of what is contributed by the verb (determined by a minimal L-thematic role contrast as above). I encode this superset relation via a function *sup*, where  $\textit{sup}(P, Q) = Q$  if  $P \subseteq Q$  and  $\perp$  if  $P \not\subseteq Q$ , updating the constraints in (30) to incorporate this:<sup>11</sup>

<sup>10</sup>I assume that specific choices of prepositions, e.g. *on(to)*, *in(to)*, are pragmatically determined and not part of the thematic role per se.

<sup>11</sup>This function is only for presentational convenience, serving to co-identify each entailment in the preposition role with something in the verb role. Spelling this out explicitly reduces AVM readability.

(34) Oblique linking (final):  $v-lxm \Rightarrow$

$$\left[ \begin{array}{l} \text{ARG-ST} \left\langle \text{PP}_{j_1} \left[ \text{ROLES} \left\{ \boxed{P_1} \right\} \right], \dots, \text{PP}_{j_m} \left[ \text{ROLES} \left\{ \boxed{P_m} \right\} \right] \right\rangle \circ \text{list}(\text{non-PP}) \\ \text{CONT} \left[ \begin{array}{l} \text{ROLES} \left\langle \boxed{Q_1}, \dots, \boxed{Q_m} \right\rangle \circ \text{list} \\ \text{RELS} \left\langle \left[ \begin{array}{l} \text{role-rel} \\ \text{ARG1 } j_1 \\ \text{ROLE } \min(\text{sup}(\boxed{P_1}, \boxed{Q_1})) \end{array} \right], \dots, \left[ \begin{array}{l} \text{role-rel} \\ \text{ARG1 } j_m \\ \text{ROLE } \min(\text{sup}(\boxed{P_m}, \boxed{Q_m})) \end{array} \right] \right\rangle \circ \text{list} \end{array} \right] \end{array} \right]$$

The constraints in (29) and (34) determine the MAP in (18). In the next section I discuss how alternations are licensed based on this.

## 5 Generating Alternations

An alternation is licensed when a verb  $V$  licenses a role  $R$  for a participant  $x$  and there also exists an oblique marker  $P$  which inherently bears a role  $Q$  such that  $Q \subseteq R$ . Thus  $x$  may be realized either as a direct argument (getting its role directly from  $V$ ) or as an oblique marked by  $P$ , getting its role based on the roles licensed by  $V$  and  $P$ . The constraints on  $v-lxm$  and a language's lexical inventory determine (a) when there is an alternation and (b) what the semantics is. For (1), all that needs to be specified for *load* is a list of roles for direct arguments and an ARG-ST (which may ultimately be derivable from the roles; see §7). No explicit linking needs to be stated (though I stipulate subject linking since I am primarily concerned with objects in this paper):

$$(35) \left[ \begin{array}{l} \text{ORTH} \langle \text{load} \rangle \\ \text{ARG-ST} \langle \text{NP}_i, \text{NP}, \text{PP} \rangle \\ \text{CONT} \left[ \begin{array}{l} \text{ROLES} \langle \boxed{1} \text{LOADER}, \text{LOCATUM}_{\text{load}}, \text{LOCATION}_{\text{load}} \rangle \\ \text{RELS} \left\langle \left[ \begin{array}{l} \text{role-rel} \\ \text{ARG1 } i \\ \text{ROLE } \boxed{1} \end{array} \right], \dots \right\rangle \end{array} \right] \end{array} \right]$$

Thus *load* is subcategorized for two NP arguments and one PP argument and licenses three thematic roles: a LOADER, a totally affected LOCATUM (specific to *load*) and a totally affected LOCATION (also specific to *load*). The linking of the roles to ARG-ST (or the form of the prepositions) is not stipulated directly in the lexical entry. This allows one role to be linked to the remaining NP argument and the other to be linked to the PP but with an underspecified role. The preposition inventory of English restricts the possible manifestations of this lexeme in a *head-complement* structure to only two kinds:



- (36) 
$$\left[ \begin{array}{l} \text{ORTH} \langle \textit{loaded, the wagon, with the hay} \rangle \\ \text{DTRS} \langle \textit{V, NP}_j, \textit{PP}_k \left[ \text{ROLES} \left\{ \boxed{1} \text{CAUSALLY-INTERMEDIATE} \right\} \right] \rangle \\ \text{CONT} \left[ \begin{array}{l} \text{ROLES} \langle \dots, \boxed{2} \text{LOCATUM}_{\textit{load}}, \boxed{3} \text{LOCATION}_{\textit{load}} \rangle \\ \text{RELS} \langle \dots, \left[ \begin{array}{l} \textit{role-rel} \\ \text{ARG1 } j \\ \text{ROLE } \boxed{3} \end{array} \right], \left[ \begin{array}{l} \textit{role-rel} \\ \text{ARG1 } k \\ \text{ROLE } \textit{min}(\textit{sup}(\boxed{1}, \boxed{2})) \end{array} \right], \dots \rangle \end{array} \right]$$
- (37) 
$$\left[ \begin{array}{l} \text{ORTH} \langle \textit{loaded, the hay, onto the wagon} \rangle \\ \text{DTRS} \langle \textit{V, NP}_j, \textit{PP}_k \left[ \text{ROLES} \left\{ \boxed{1} \text{LOCATION}_{\textit{goal}} \right\} \right] \rangle \\ \text{CONT} \left[ \begin{array}{l} \text{ROLES} \langle \dots, \boxed{2} \text{LOCATUM}_{\textit{load}}, \boxed{3} \text{LOCATION}_{\textit{load}} \rangle \\ \text{RELS} \langle \dots, \left[ \begin{array}{l} \textit{role-rel} \\ \text{ARG1 } j \\ \text{ROLE } \boxed{2} \end{array} \right], \left[ \begin{array}{l} \textit{role-rel} \\ \text{ARG1 } k \\ \text{ROLE } \textit{min}(\textit{sup}(\boxed{1}, \boxed{3})) \end{array} \right], \dots \rangle \end{array} \right]$$

Acceptable structures similar to (37) are licensed by other locational goal markers (e.g. *in(to)*), but otherwise no other preposition (e.g. *about* or *with*) satisfies the criterion that the oblique marker role be a subset of the verb role. Likewise, presumably *with* is the only CAUSALLY-INTERMEDIATE marker in English (*by*, *via*, etc. mark more specific means/manner roles not subsets of  $\text{LOCATUM}_{\textit{load}}$ ). Any other oblique markers, or different linking with the same ones, would lead to a unification failure.<sup>12</sup> Furthermore, no verbal polysemy is required to license the alternation, which arises from the underspecified linking.<sup>13</sup>

Since the lexical and morphosyntactic inventory of argument realization devices determines the shape of alternations this approach also makes predictions about which alternations will or will not occur in a given language. For example, French and Spanish both appear to lack a dative alternation of the form in (5). However, both languages also generally lack any type of general allative marker comparable to English *to* for marking goals of motion that could alternate with dative *a* (Talmy 2000). Conversely, Finnish exemplifies the other alternative: all goal/recipient participants are marked in the allative case and there is no alternation, reflecting the general lack of a dative case or double object constructions in Finnish (Karlsson 1999). Thus the lack of alternations is correlated with the general lack of certain types of realization devices. A slightly more subtle example of such a correlation can be found with Japanese verbs of removal. In English, verbs of removal, like locative alternating verbs, allow either the location or the locatum to be realized as the direct object:

<sup>12</sup>For the first object position of double-object verbs, which has no (overt) oblique marker in English but bears possessional semantics (as discussed in §1), the oblique-like semantics could be defined as special type of ARG-ST with three NP arguments, the middle one being restricted to possessors, or else in terms of a special double object construction.

<sup>13</sup>See also Markantonatou and Sadler (1995), who likewise assume underspecified verbs but with a complex semantics involving reified proto-roles *causer/patient* similar to ACT/UND above.

- (38) a. John cleared the dishes from the table.  
 b. John cleared the table of the dishes.

In (38a), where the locatum is the direct object, the location is marked by the source marker *from*. In (38b) the location is realized as direct object but the locatum is marked by *of*, which is historically an erstwhile ablative (<Old English *æf*, related to *off* according to the OED) and has various functions marking separation/source semantics (e.g. *Little (be)came of it*, *We desired it of him*, *She died of disease*, *He partook of the salad*). Due to its function as both a locatum (akin to an instrument) and ablative marker, Hook (1983) refers to *of* as an “abstrument” marker. In Japanese, removal verbs also alternate (cf. Kageyama 1980:38, (10)):

- (39) a. *Ueetaa-wa syokutaku-kara syokki-o katazuketa.*  
 waiter-TOP table-from dishes-ACC cleared.  
 ‘The waiter cleared the dishes from the table.’  
 b. *Ueetaa-wa syokutaku-o (\*syokki-de/kara) katazuketa.*  
 waiter-TOP table-ACC (\*dishes-INST/from) cleared.  
 ‘The waiter cleared the table (of the dishes).’

In (39a) the locatum is the direct object and the location is marked by *-kara* ‘from’. But in (39), when the location is direct object, there is no grammatical way to realize the locatum as an oblique. This correlates, however, with a general lack of an abstrument marker in Japanese with the functionality of the English *of*. Thus these data reflect a general correspondence of the shape of the lexicon and the possibilities of alternations: if no marker independently realizes a role compatible with a certain verb’s, then furthermore there should be no alternation with that verb.

One potential problem for this analysis is so-called “default” prepositions that mark arguments when for some reason the governing head is unable to assign case (Chomsky 1981). If such prepositions exist they presumably are semantically vacuous (serving only a grammatical role), which would mean licensing an empty role on the approach outlined here. However, an empty role is a subset of any role assigned by any verb, and thus any direct argument should alternate with the default preposition.<sup>14</sup> Clearly this is not the case. So what, then, do we say about default prepositions? I again appeal to a lexical solution by suggesting that “default” prepositions simply do not exist, at least not in the verbal domain.

The most common candidate for a default preposition is English *of* since it occurs universally as a complement marker for nouns (e.g. *the destruction of the city/the Romans*; Chomsky 1970), adjectives (e.g. *fond of Mary*), and sometimes prepositions (e.g. *off of the rock*). Similar prepositions occur in other languages (e.g. Japanese *-no* likewise marks nearly all arguments of nouns; Martin 1975). However, as far as I am aware, most uses of *of* in the verbal domain are in its abstrument/source use, with some uses also as a material/topic role (e.g. *wrote of him*,

<sup>14</sup>I would like to thank an anonymous reviewer for pointing out this possibility to me.

*notified of the plans*) or as a comparative (e.g. *it tastes of mutton*). Thus while *of* is perhaps a few ways polysemous, it is not clear that it is semantically vacuous. As much as it is a default preposition in non-verbal domains it is in some sense a direct argument marker and thus should not be subject to constraints on obliques parallel to those in (34). A second candidate for “default” status is the agentive *by* that occurs with verbs in the passive voice marking demoted subjects. It is well known that virtually any subject of any active transitive verb in English can be marked by *by* in the passive (Fillmore 1968), suggesting that *by* carries no inherent semantics except as a general proto-agent marker. If this is the case then the theory outlined here would predict that we should see nominative/*by* alternations in the active voice, e.g. *John saw Mary* and *By John saw Mary*. This I suggest is ruled out by independent constraints on argument structure. Nearly every grammatical theory has some version of the GB Extended Projection Principle (EPP) (Chomsky 1981), such as the Final-1 Law in Relational Grammar (Perlmutter and Postal 1983), the Subject Condition in LFG’s Lexical Mapping Theory (Bresnan and Kanerva 1989), and constraints in HPSG that the first element of a verb’s ARG-ST be an NP (Ginzburg and Sag 2000). As much as it is true that languages tend to resist non-NP subjects (except CPs) then what rules out a *by* alternation are constraints on argument structure preventing oblique first arguments (except where lexically specified by the verb, i.e. dative subjects in Russian or Icelandic). Thus there does not appear to be any evidence of a truly default preposition in English for verbal argument marking, and I am not aware of any such evidence in any other languages.

## 6 Comparison to Ackerman and Moore

The approach proposed here bears some similarity to Ackerman and Moore’s (2001) approach to oblique realization, and a discussion of the differences is certainly in order. Ackerman and Moore (2001) propose that direct arguments are “more prototypical” than obliques relative to Dowty’s proto-roles according to their PARADIGMATIC ARGUMENT SELECTION PRINCIPLE (*ibid.*:169, (2)):

- (40) PARADIGMATIC ARGUMENT SELECTION PRINCIPLE:  
 Let  $P(\dots, arg_i, \dots)$  and  $P'(\dots, arg'_i, \dots)$  be related predicates, where  $arg_i$  and  $arg'_i$  are corresponding arguments. If  $arg_i$  and  $arg'_i$  exhibit different grammatical encodings and  $arg_i$  is more prototypical with respect to a particular proto-role than  $arg'_i$ , then  $arg_i$ ’s encoding will be less oblique than  $arg'_i$ ’s encoding.

Thus for Ackerman and Moore every alternation reflects a paradigmatic relationship between two verb forms with different thematic role and argument structure assignment. One form takes argument  $i$  as a direct argument, the second as an oblique, and the former assigns a “more prototypical” role to  $i$  than the latter. However, what Ackerman and Moore mean by “more” prototypical is not specified. The analyses they propose involve the direct argument bearing an additional proto-role entailment not borne by the oblique. However, nothing in their approach indicates (a) which proto-role entailments will vary for a given alternation and (b)

whether or not the less prototypical role contains any non-proto-role entailments not assigned to the more prototypical role, including even the negation of one of the relevant proto-role entailments. On my approach, the contrasts are assumed to follow from a more general notion of possible contrasts and “more prototypical” is given a specific interpretation in terms of underspecificity, making a stronger claim, as well as detailing how these entailments connect to more verb-specific ones.

Furthermore, my approach, though defining thematic roles as sets of entailments, is not wedded to proto-roles and thus captures a broader set of generalizations. For direct objects there is evidence for a proto-patient analysis given the variability in what can be an object, for instance all of the L-thematic roles above are found associated with the object of some verb in English:

- (41) a. John ate the bread. (TOTALLY AFFECTED)  
 b. John tore the bread. (AFFECTED)  
 c. John touched the bread. (PARTICIPANT)

The direct object may bear nearly any role provided it is the most like the proto-patient for a given verb, and similarly subjects show a wide range of thematic role variability, suggesting a proto-agent analysis for subjecthood. However, there is no evidence for a corresponding “proto-recipient” role for first objects of ditransitive verbs, since first objects are categorically possessors (or perhaps more generally the subject of some kind of HAVE predicate as in Green 1974). No ditransitive verb selects a first object that does not meet this requirement, i.e. there is no ditransitive taking a goal as a first object. However, the MAP given in (18) nonetheless predicts the semantics of dative alternation as discussed in §1, since it makes claims about the roles assigned to direct arguments vs. obliques regardless of whether a proto-role is involved in the analysis. It is not clear how Ackerman and Moore’s approach explains this, suggesting that the analysis proposed here has broader application.

## 7 Conclusion

The approach to argument/oblique alternations proposed here has three advantages over previous work. First, it captures the general underspecificity contrasts that govern such alternations and does so in a way that transparently links verb, verb class, and alternation specific generalizations. Individual thematic roles inherently cluster together at different levels of granularity in terms of shared entailments, predicting that verbs will cluster together into classes that behave similarly for certain semantic contrasts. Alternations operate at a very high level of generality (the level of L-thematic roles) and thus large numbers of loosely connected verbs may undergo the “same” alternations keyed to very general semantic criteria but manifest these alternations in different ways. Second, this approach reduces the amount of polysemy needed to capture alternations. Third, the form-to-meaning mapping is encoded without intermediate structure such as predicate decompositions or structured EPs as in Koenig and Davis (2004). This approach does assume

thematic role types, an additional construct needed to develop a general theory of possible contrasts. However, the existence of thematic role types follows naturally from assuming that thematic roles are sets of entailments, since sets of entailments may inherently share members (though as noted above only certain thematic role types, the L-thematic roles, are relevant for linguistic generalizations). The additional semantic constructs posited by predicate decomposition theories, however, involve a type of structure that does not fall organically out of the entailments verbs associate with their arguments.

However, this analysis is by no means complete; I have ignored several issues here. First of all, there is the question of how subject and object linking happen more generally, and for this we presumably still need a proto-role theory as in Dowty (1991). In this sense the approach outlined here represents a step towards bringing obliques into the theory of Dowty. Second, I have not dealt here with verbs that do not undergo alternations (e.g. *put* and *fill* are English locative verbs that do not alternate). However, these can be analyzed in terms of proto-roles as well, where for a verb like *load* the two participants are equally as proto-patientive, while *put* and *fill* asymmetrically associated more proto-patient entailments with one argument, ensuring that it is always the direct object. For more on these two points see Beavers (to appear b). Third, I have not dealt with non-semantically based alternations, i.e. those that do not mark a difference in interpretation (e.g. *John blamed Jo for his problems/his problems on Jo*). However, it is well known that other factors may govern alternations, such as animacy, referentiality, heaviness, definiteness, etc. (Erteschik-Shir 1979, Wasow 2002, Aissen 2003). Thus the MAP is just one of many harmonic alignment principles, and a more general theory of argument realization must integrate all of these factors (as suggested also by Fillmore 1977 and Davis and Koenig 2000).

Finally, I make no predictions about which argument structures a given verb may have (having assumed e.g. that *load* takes one PP and two NP arguments). However, degrees of affectedness are known to partly govern transitivity cross-linguistically (cf. Hopper and Thompson 1980, Tsunoda 1981, Testelec 1998), and ditransitivity is cross-linguistically correlated with transfer of possession (Croft et al. 2001). Thus some aspects of argument structure, which I assume is partly independent of linking (cf. Davis 2001), may be predictable by the same criteria that govern alternations. How these interact is a matter of future investigation.

## References

- Ackerman, Farrell and Moore, John. 2001. *Proto-Properties and Grammatical Encoding: A Correspondence Theory of Argument Selection*. Stanford, CA: CSLI Publications.
- Aissen, Judith. 2003. Differential Object Marking: Iconicity vs. Economy. *Natural Language and Linguistic Theory* (21), 435–483.

- Anderson, Stephen R. 1971. On the Role of Deep Structure in Semantic Interpretation. *Foundations of Language* 7(3), 387–396.
- Beavers, John. To appear a. Scalar Complexity and the Structure of Events. In Johannes Dölling and Tatjana Heyde-Zybatow (eds.), *Event Structures in Linguistic Form and Interpretation*, Berlin: Mouton de Gruyter.
- Beavers, John. To appear b. Thematic role specificity and argument/oblique alternations in English. In *Proceedings of WECOL 2004*, University of Southern California, Los Angeles.
- Bresnan, Joan and Kanerva, Jonni M. 1989. Locative Inversion in Chicheŵa. *Linguistic Inquiry* 20(1), 1–50.
- Chomsky, Noam. 1970. Remarks on Nominalization. In Roderick A. Jacobs and Peter S. Rosenbaum (eds.), *Readings in English Transformational Grammar*, pages 184–221, Waltham, MA: Ginn.
- Chomsky, Noam. 1981. *Lectures on Government and Binding*. Dordrecht: Foris.
- Copestake, Ann, Flickinger, Dan, Sag, Ivan and Pollard, Carl. 2003. Minimal Recursion Semantics: An Introduction, <http://www.cl.cam.ac.uk/~acc10/papers/newmrs.ps>.
- Croft, William. 1991. *Syntactic Categories and Grammatical Relations: The Cognitive Organization of Information*. Chicago: University of Chicago Press.
- Croft, William, Barðdal, Jóhanna, Hollmann, William, Nielsen, Maike, Sotirova, Violeta and Taoka, Chiaki. 2001. Discriminating Verb Meanings: The Case of Transfer Verbs, handout, LAGB Autumn Meeting, Reading.
- Davis, Anthony. 2001. *Linking by Types in the Hierarchical Lexicon*. Stanford, CA: CSLI Publications.
- Davis, Anthony and Koenig, Jean-Pierre. 2000. Linking as constraints on word classes in a hierarchical lexicon. *Language* 76(1), 56–91.
- Dowty, David. 1989. On The Semantic Content of the Notion ‘Thematic Role’. In Gennaro Chierchia, Barbara H. Partee and Raymond Turner (eds.), *Properties, Types, and Meaning*, Dordrecht: Kluwer Academic Publishers.
- Dowty, David. 1991. Thematic Proto-Roles and Argument Selection. *Language* 67(3), 547–619.
- Erteschik-Shir, Nomi. 1979. Discourse Constraints on Dative Movement. In Talmy Givón (ed.), *Discourse and Syntax*, pages 441–468, New York: Academic Press.
- Fillmore, Charles J. 1968. The Case for Case. In Emmon Bach and Robert T. Harms (eds.), *Universals in Linguistic Theory*, New York: Holt.

- Fillmore, Charles J. 1977. The Case for Case Reopened. In Peter Cole and Jerrold M. Sadock (eds.), *Grammatical Relations*, pages 59–82, New York: Academic Press.
- Gawron, Jean Mark. 1986. Situations and Prepositions. *Linguistics and Philosophy* 9, 327–382.
- Ginzburg, Jonathan and Sag, Ivan A. 2000. *Interrogative Investigations: The Form, Meaning, and Use of English Interrogatives*. CSLI Publications.
- Green, Georgia. 1974. *Semantic and Syntactic Regularity*. Bloomington, IN: Indiana University Press.
- Harley, Heidi. 2003. Possession and the Double Object Construction. In Pierre Pica and Johan Rooryck (eds.), *Linguistic Variation Yearbook 2*, pages 31–70, Amsterdam: John Benjamins.
- Hay, Jennifer, Kennedy, Christopher and Levin, Beth. 1999. Scalar Structure Underlies Telicity in Degree Achievements. In *The Proceedings of SALT IX*, pages 127–144.
- Hook, Peter. 1983. The English Abstrument and Rocking Case Relations. In *Proceedings of CLS 19*, pages 183–194.
- Hopper, Paul J. and Thompson, Sandra A. 1980. Transitivity in Grammar and Discourse. *Language* 56(2), 251–299.
- Jackendoff, Ray. 1990. *Semantic Structures*. Cambridge, MA: MIT Press.
- Kageyama, Taro. 1980. The Role of Thematic Relations in the *Spray Paint* Hypallage. *Papers in Japanese Linguistics* 7, 35–64.
- Karlsson, Fred. 1999. *Finnish: An Essential Grammar*. New York: Routledge.
- Koenig, Jean-Pierre and Davis, Anthony. 2003. Semantically Transparent Linking in HPSG. In Stefan Müller (ed.), *Proceedings of the 2003 HPSG Conference*, Stanford, CA: CSLI Publications.
- Koenig, Jean-Pierre and Davis, Anthony. 2004. The KEY to lexical semantic representations, unpublished ms., University at Buffalo, the State University of New York.
- Kordoni, Valia. 2002. Valence Alternations in Greek: an MRS Analysis. In Jong-Bok Kim and Stephen Wechsler (eds.), *Proceedings of the HPSG 2002 Conference*, pages 129–146, Stanford, CA: CSLI Publications.
- Kordoni, Valia. 2004. Between Shifts and Alternations: Ditransitive Constructions. In Stefan Müller (ed.), *Proceedings of the HPSG 2004 Conference*, pages 151–167, Stanford, CA: CSLI Publications.

- Levin, Beth. 1993. *English Verb Classes and Alternations: A Preliminary Investigation*. Chicago: University of Chicago Press.
- Levin, Beth and Rappaport, Malka. 1988. What to do with  $\Theta$ -Roles. In Wendy Wilkins (ed.), *Thematic Relations*, San Diego, CA: Academic Press.
- Levin, Beth and Rappaport Hovav, Malka. 1998. Morphology and Lexical Semantics. In Andrew Spencer and Arnold Zwicky (eds.), *The Handbook of Morphology*, Oxford, UK: Blackwell.
- Markantonatou, Stella and Sadler, Louisa. 1995. Linking Indirect Arguments and Verb Alternations In English. In Francis Corblin, Danièle Godard and Jean-Marie Marandin (eds.), *Empirical Issues in Formal Syntax and Semantics*, pages 103–125, Berne: Peter Lang.
- Martin, Samuel. 1975. *A Reference Grammar of Japanese*. New Haven: Yale University Press.
- Perlmutter, David M. and Postal, Paul. 1983. Some Proposed Laws of Basic Clause Structure. In David M. Perlmutter (ed.), *Studies in Relational Grammar I*, Chicago, IL: University of Chicago Press.
- Pesetsky, David. 1995. *Zero Syntax: Experiencers and Cascades*. Cambridge, MA: MIT Press.
- Pinker, Stephen. 1989. *Learnability and Cognition*. Cambridge, Mass: MIT Press.
- Silverstein, Michael. 1976. Hierarchy of Features and Ergativity. In R.M.W. Dixon (ed.), *Grammatical Categories in Australian Languages*, pages 112–171, Canberra: Australian Institute of Aboriginal Studies.
- Talmy, Leonard. 2000. *Toward a Cognitive Semantics: Typology and Process in Concept Structuring*. Cambridge, Mass.: MIT Press.
- Testelec, Yakov G. 1998. On Two Parameters of Transitivity. In Leonid Kulikov and Heinz Vater (eds.), *Typology of Verbal Categories*, pages 29–45, Tübingen: Niemeyer.
- Tsunoda, Tasaku. 1981. Split Case-Marking in Verb-Types and Tense/Aspect/Mood. *Linguistics* 19, 389–438.
- Van Valin, Robert D. 2002. The Role and Reference Grammar Analysis of Three-Place Predicates, unpublished ms., The State University of New York at Buffalo.
- Wasow, Thomas. 2002. *Postverbal Behavior*. Stanford, CA: CSLI Publications.
- Wechsler, Stephen. 1995. *The Semantic Basis of Argument Structure*. Stanford, CA: CSLI Publications.



# Integrating pragmatic information in grammar: An analysis of intersentential ellipsis

Núria Bertomeu

Saarland University

Valia Kordoni 

Saarland University

Proceedings of the 12th International Conference on  
Head-Driven Phrase Structure Grammar

Department of Informatics, University of Lisbon

Stefan Müller (Editor)

2005

Stanford, CA: CSLI Publications

pages 49–69

Bertomeu, Núria & Valia Kordoni. 2005. Integrating pragmatic information in grammar: An analysis of intersentential ellipsis. In Stefan Müller (ed.), *Proceedings of the 12th International Conference on Head-Driven Phrase Structure Grammar, Department of Informatics, University of Lisbon*, 49–69. Stanford, CA: CSLI Publications. DOI: 10.21248/hpsg.2005.3. 

## Abstract

In this paper we present a proposal to integrate pragmatic information, both from the preceding discourse and the extra-linguistic context, in the grammar. We provide an analysis of elliptical fragments according to how they are anchored to the context and the kind of resolution they require. We also present an alternative view about the syntax of fragments.

## 1 Introduction

The minimal independent unit of meaning is a message containing an event/state state-of-affairs. In human communication meaning is usually expressed by linguistic means. However, often meaning is only expressed implicitly, that is, certain pieces of meaning are omitted and must be recovered from the context or even inferred. This is also the case for intersentential ellipsis, where the previous discourse usually provides the contextual anchor for the fragment and sometimes even tells us how to resolve it. But not seldom it is the communicative context which provides the contextual anchor for the fragment. Sometimes, even knowledge is required for the resolution.

The grammar explicitly defines what is a root sentence. Root sentences have as content a proposition with an illocutionary force relation which takes as argument a message, as proposed by Ginzburg et al. (2003). Elliptical fragments are also interpreted as performing a speech act over a message. They are, thus, root sentences. However, their content cannot be built up only with the content of its parts, that is, compositionally, but must be recovered from the context or be partially inferred. For this to be possible, fragments have to necessarily be uttered within the appropriate context. If this is not the case, they cannot be raised to the category of sentence and are mere constituents. Stand-alone constituents which cannot be raised to sentences are infelicitous, if not ungrammatical, since as argued above the minimal independent unit of meaning is the sentence. In our opinion grammar should define not only what is syntactically well-formed, but also what is semantically well-formed. In the case of fragments semantic well-formedness can only be defined with respect to the context and other pragmatic issues.

One of our aims in this paper is to present a grammar/pragmatics interface which allows us to place constraints on the use of stand-alone constituents. We propose a unified account of a wide range of fragments based on the notion of focus of attention. We present a new dimension for the classification of fragments based on the kind of resolution they require and on their anchoring to the context.

Another aim of this paper is to show, contrary to what previous approaches to the analysis of fragments claim, that the remnant/s is not the head-daughter of the fragment, and that this is phonetically empty. We will also claim, contrary to the established views too, that no constraint is needed for ensuring syntactic parallelism between the remnant of the fragment and some parallel element in the source. Furthermore, we argue that there is no such syntactic parallelism.

In the next section we will discuss previous approaches to the resolution of intersentential ellipsis and explain how our proposal differs from them. In section 3 we propose an alternative to the syntax of fragments. In section 4 we give a general overview of the overall architecture for discourse understanding/production in which our analysis of elliptical fragments is framed. In section 5 we present a proposal for the formalization and in section 6 we summarize and conclude.

## 2 Previous approaches to the resolution of fragments

In the present section we are discussing two previous approaches to the analysis of fragments in dialog proposed within the framework of HPSG (see Pollard and Sag (1994)).

### 2.1 The grammar-based approach

In Ginzburg and Sag (2001), a.o., an account of fragment resolution is proposed, which covers short answers, clarification requests and sluices. Our approach shares with it the view that the felicitous use of fragments must be constrained from within the grammar. However, in our opinion their analysis is not straightforwardly extendible to account for fragments lacking an explicit linguistic source, like in (1), since their resolution procedure takes only into account semantic structural information.

- (1) > Has Anastacia released any CDs in the last year?
  - Yes, "Left outside alone".
  - > Any prizes?

In this approach it is explicitly stated how a fragment should be resolved. This is achieved by structure-sharing of the  $\text{CONT(ENT)|SOA|NUCL}$  values of the  $\text{MAX(IMAL)-Q(UESTION)U(NDER)D(ISCUSSION)}$  and the mother of the fragment. The remnant of the fragment is its head-daughter and shares values for  $\text{CONT(ENT)}$  and  $\text{CAT(EGORY)}$  with the  $\text{SAL(IENT)-UTT(ERANCE)}$ , which has as value a singleton or empty set and is defined as the parallel element in the source.  $\text{MAX-QUD}$  has as value an object of type question whose value for the feature  $\text{PARAM(ETER)S}$  usually corresponds to the salient utterance. The Maximal Question under Discussion is defined as the issue currently being talked about. Every new utterance raises a Maximal Question under Discussion, which is the question at the top of the stack of  $\text{Q(UESTIONS)-U(NDER)-D(ISCUSSION)}$ .  $\text{QUD}^1$  determines the structure of the discourse and its stack behavior allows questions to become maximal once sub-questions depending on them have been resolved.  $\text{MAX-QUD}$  is taken to be the source upon which the fragment is resolved.

---

<sup>1</sup>QUD is part of the DGB (Dialog Game-board) together with  $\text{FACTS}$ , a set of facts corresponding to the information taken for granted by the CPs, and  $\text{LATEST-MOVE}$ , the content of the latest move made, an illocutionary fact.

But the antecedent of a fragment doesn't always correspond to the Maximal Question under Discussion. This is not the case for genuine information-seeking elliptical questions, as the one shown in (2):

- (2) > How much is the new U2-CD?  
- 20 Euros.  
> And the one from 2Pac?  
"How much is the new 2Pac-CD?"

Ginzburg is aware of this and, having direct sluices in mind, states another place for holding antecedents, namely FACTS|TOPICAL (see Ginzburg (1997)). TOPICAL, concerns soas belonging to questions under discussion at that point in the dialog. Questions which get down-dated from QUD also get down-dated from TOPICAL. There is, however, a one move lag between the down-dating of questions from QUD and the disappearance of the addresses they provide in TOPICAL. However, in (2) the source doesn't fall under the definition of TOPICAL.

The theory assumes that a CP always tries to accommodate elliptical utterances as filling the abstracted slot in some question to which the fragment is a relevant answer given the current information state and according to some definition of question-answer relevance. Being able to resolve the fragment involves being able to accommodate a question. However, little is said about the reasoning involved in deciding which question is to be accommodated. Moreover, this question as well as the resolved fragment are represented at the semantic-structural level, however in examples like (3) we cannot have as the result of resolution a semantic-structural representation, since this would involve to choose a particular predicate for the relation in the soa, which would be an arbitrary decision.

- (3) - Einen Kaffee, bitte.  
A coffee<sub>acc.masc.sg.</sub>, bitte.  
'- A coffee, please.'

## 2.2 The coherence-based approach

Unlike in the previous approach, Schlangen (2003) considers the resolution process as something external to the grammar. The grammar gives us an analysis of the fragment which is underspecified for all the resolution possibilities. The remnant contributes to the compositional semantics of the fragment independently of what the resolved fragment turns out to be. The only information provided by the construction type licensing fragments is that the remnant is an argument or adjunct of an event unknown relation.

Schlangen explains within the framework SDRT (Asher & Lascarides, 1993, 2003) how the underspecified semantics of fragment is resolved in dialog. In SDRT rhetorical relations constrain where new information can attach, adopting the Right-Frontier Constraint<sup>2</sup>. Interpretation amounts to inferring rhetorical relations and maximizing discourse coherence, that is, defining a partial order on

<sup>2</sup>This issue is discussable. See Alcántara and Bertomeu (2005) for examples where this is not the case.

the resulting interpretations, the maximum of which will be the pragmatically preferred reading.

Schlangen distinguishes between two kinds of fragments: those which can be resolved via-identity, that is, where there is an explicit linguistic source sharing structural identity with the fragment, and upon which the fragment can be resolved; and those which have to be resolved via-inference, that is, when there is no linguistic source or only a partial one and some inference has to be done in order to resolve the fragment.

Most resolution via-identity is based on structural similarity between the source and the fragment. Saturation constraints ensure that there is a mapping between the focus-background partition of the source and the fragment. Each rhetorical relation involves a different saturation constraint. So fragment resolution amounts to inferring the rhetorical relation which holds between fragment and source and choosing the solution which maximizes the discourse coherence. Once a fragment-source pair is chosen substitution of the focused parts is carried out. But, if resolution via-identity is achieved in the end by substitution of structurally identical representations, why do we need to infer any rhetorical relations?

One of the problems of this approach is that the grammar doesn't constrain the use of fragments at all. Moreover, the output of the parser is a description which denotes an infinite set containing all the possible resolutions. To infer all possible relations and then rank them upon their coherence is a computationally costly process. We believe that in the parsing stage implausible interpretations are already ruled out. However, this is only possible if the grammar takes context into account and interfaces with other modules. Although the grammar cannot contain full information about how a fragment should be resolved because of uncertainty, it should restrict as much as possible the set of possible resolutions. In this sense, HPSG is an adequate framework to formalize this, since it allows to express constraints from the different linguistic levels in a single representation, including, thus, pragmatics.

### **3 The syntax of fragments**

#### **3.1 The head-daughter of fragments**

Both approaches discussed in the previous section consider that the remnant is the head-daughter of the fragment. The GHFP, which states that mother and daughter must share values for the feature HEAD by default, is, thus, overridden. This is, however, problematic when we want to account for fragments formed by more than one constituent independent from each other (gapping), like those shown in (4). Upon which reasons can we here decide which constituent is the head-daughter?

- (4) > When did 2-Pac release "All eyez on me"?
- > And Michael Jackson "Thriller"?

In Ginzburg and Sag (2001)'s approach the sole requirement that the salient utterance be the singleton or empty set already hinders an account of fragments presenting gapping.

Also in the psycholinguistic literature it has been claimed that the most psychologically plausible parsing mechanism is left-corner parsing, as stated in Crocker (1999). The human parser already begins building structure as soon as it encounters a new item. For fragments this would mean that the parser posits an empty head which is then semantically filled when resolving the fragment. This is less costly than analyzing the constituent provided in the fragment as the head and then reanalyzing when a sister or the real semantic head is encountered. From the point of view of the syntax-semantics interface it is also desirable that there is parallelism between the syntactic and semantic structures.

Unlike in previous approaches, in our analysis for fragments remnants will be non-head daughters, while the feature head-daughter will be phonetically empty. This approach is in the same line as the analysis of intra-sentential gapping proposed by Gregory and Lappin (1997), where the elliptical clause has a phonetically-null head-daughter and the remnants are, thus, non-head-daughters.

### 3.2 Syntactic parallelism

These two approaches share the view that the remnant must share some syntactic features with some parallel element in the source. Ginzburg and Sag (2001) account for this by constraining the values for the feature CAT of the salient utterance and the remnant of the fragment to be the same.

However, especially for adjuncts this is not always the case. Adjuncts can be propositional phrases, subordinated clauses and adverbs, and so it's not difficult to find parallel elements which differ in category like in the following example.

- (5) > How should I eat this?  
- With your hands. / As slowly as you can. / Enjoying it.

As pointed out by Schlangen (2003), one has to allow some degrees of freedom in what counts as the salient utterance, in order to account for the optionality of PP/NP in some fragments like the following:

- (6) > Where do you come from?  
- Germany. / From Germany.

To account for categorial congruence between source and fragment, Schlangen introduces a syntactic constraint. If the semantic constraints of a certain relation force a resolution that is semantically very close to an antecedent, then syntactic congruence is also demanded. If the syntactic parallelism is violated, the semantically close resolution cannot be the intended one.

However, we think that no such constraints requiring syntactic parallelism between the remnant and some parallel element in the source are required. Note that

optional arguments not present in the source are also subject to subcategorization requirements.

(7) Peter was reading when I saw him. A book about Montague semantics, I think.<sup>3</sup>

Syntactic parallelism seems to be just a consequence of the SUBCATEGORIZATION PRINCIPLE. In cases where resolution via-identity is required, a little extension of the SUBCATEGORIZATION PRINCIPLE in which it is stated that remnants must fulfill the subcategorization requirements of the predicate with which they are resolved would be enough to ensure the syntactic appropriateness of remnants.

The example in (3) from German shows that remnants must have certain syntactic features, be in a certain category and case, even when there is no explicit linguistic source and, thus, no parallel element. We don't think this kind of fragments must be resolved with a lexical predicate, since there are several possibilities and to choose a particular one would be arbitrary. They must be rather resolved with a much more general default predicate at the semantic-conceptual level.

Wierzbicka (1988) proposes that syntactic constructions and morphology have a semantics on their own. This is also true for category and case. A particular case can appear in a wide variety of constructions, but one can find a core meaning, a common theme which links all different constructions in which this case can appear.

Considering this, the only thing we need in order to ensure syntactic appropriateness of remnants without source is a principle similar to the SUBCATEGORIZATION PRINCIPLE, which states that remnants must be realized in the surface form corresponding to the semantics of the role they fill in the semantic-conceptual representation. Note that this requires a transparent interface between deep semantics and syntax.

#### **4 Overall architecture: context, knowledge and focus of attention<sup>4</sup>**

We will distinguish between two types of ellipsis resolution: *resolution via-identity* and *resolution via-inference*<sup>5</sup> and two levels of representation at which the resolution can take place: semantic-structural and semantic-conceptual. (2), (4) and (5) are typical examples of fragments which require *resolution via-identity*. (1) is an example of a fragment requiring *resolution via-inference*. The first type finds its antecedent in the previous source, however for the second type there seem to be two sources of context anchoring: the previous discourse and the surrounding physical environment<sup>6</sup>.

---

<sup>3</sup>This example is taken from Schlangen (2003).

<sup>4</sup>The discourse model presented here is part of Núria Bertomeu's PhD work.

<sup>5</sup>We will adopt the terminology proposed by Schlangen (2003).

<sup>6</sup>For empirical evidence on this see Alcántara and Bertomeu (2005).

## 4.1 Resolution at the semantic-structural level: the discourse-record

The discourse-record keeps track of the utterances performed. It is a memory buffer containing representations of the utterances in the order in which they have been uttered.

Surface and structural information rapidly decays from memory while semantic information remains for a longer time, see i.e. Kintsch and van Dijk (1978). This effect of decay of the surface representation of sentences from memory is reflected in our discourse-record. We will distinguish the following levels of utterance representation: phonological-positional (a serially-ordered, phonologically-specified string), functional or semantic-structural (an abstract linguistic representation with lexical-predicates and the assignment of their particular argument roles), semantic-conceptual (a deep semantic representation with conceptual predicates and the assignment of their particular argument roles), and meta-information about the utterance (the speech act performed with it and the speaker who contributed it). The phonological-positional representation is the first to be forgotten, followed by the functional representation. The other two levels remain longer in memory. As the discourse advances the representation of utterances may disappear from the memory buffer in a more or less first-in first-out fashion, although more important general issues may remain longer than more specific less important information. As discourse entities are introduced in the discourse they also enter a pool. In this pool there are no utterance representations as such, but representations of objects being talked about and part of the properties being assigned to them during the discourse as well as the inferences drawn on them. These objects are what in LuperFoy (1991) are called *pegs*. This accounts for the fact that after some time we don't remember exactly what we said in a conversation, but we remember the things we talked about.

Those sentences whose semantic-structural representation is still in the discourse-record are available as antecedents for ellipsis resolution via-identity at the semantic-structural level. We assume that at least the semantic-structural representation of the two previous utterances is retained. This accounts for follow-up questions like the one in (2).

## 4.2 Resolution at the semantic-conceptual level

There are cases of greater distances between fragment and source where we cannot consider that the semantic-structural representation of the source is still available in memory. Sometimes even there is no such explicit linguistic source. Ellipsis resolution, then, is carried out at the semantic-conceptual level.

### 4.2.1 Attention

Focus of attention can be understood as activation. Mental representations whose activation degree is over some threshold can be considered to be in focus of attention. There is a partial order of activation degrees. As the discourse advances a



common activation path is defined for all CPs<sup>7</sup>. When a speaker chooses to refer to something elliptically he believes that the hearer has his focus of attention placed in the same mental representation as he does and, thus, will be able to understand the utterance.

Recency is one of the factors influencing activeness, however goals and associated knowledge too. Ellipsis is a local phenomenon, so the source of ellipsis will be the most active representation in the focus of attention or else a representation whose structural semantics is still in memory. Of course, it can be the case that a sentence's structural-semantic representation is in memory and it is also in focus of attention. In such cases, the resolution will take place at the semantic-structural level of representation. It also can be the case that the semantic-structural representation of a sentence is still available in memory but it is not the thematic focus at that point in the dialog. In those cases we can still say that the representation is somehow active because it has been recently uttered, but it is not at the top of the focus of attention.

Our notion of top of the focus of attention will be thematic and will correspond to the things being talked about at a certain point in the conversation. There will be the following conceptual-semantic representations in the top of the focus of attention<sup>8</sup>:

- an open issue: the representation of an utterance whose associated goals have not been fully achieved, but whose achievement is a priority at that point.
- an issue which given the situation and task carried is the associated with a domain-relevant goal which has to be resolved at that point.
- a discourse-object recently uttered.
- an object in the communicative context.

#### 4.2.2 The action plan

An issue remains open if upon the goals of the CPs enough information about that issue has not yet been provided/obtained. Keeping track of the discourse goals of the CPs captures the activeness of certain utterances.

We agree with Carberry (1985) on the view that the discourse goals are necessary to keep track of issues under discussion<sup>9</sup>. Discourse goals take as arguments the semantic representations of issues. They are pushed into a stack. When goals are achieved, issues aren't any more under discussion, they can be hacked out as closed and they aren't any more accessible as sources for ellipsis unless their

---

<sup>7</sup>Of course, there can be divergences from this path, which cause misunderstandings.

<sup>8</sup>Ellipsis of representations which are not any more on the top of the focus of attention is also possible, but the utterer must provide some retrieval cue by repeating a part of the representation or pointing to the particular object.

<sup>9</sup>We don't agree with the view that understanding ellipsis always requires complex inferences on the task-related goals of the speaker. As we will explain below the knowledge base already allows us to interpret fragments which presuppose some knowledge of the world.

semantic-structural representation is still in the memory buffer. This allows to simulate the stack behavior of QUD in a memory buffer without needing any extra data-structure for utterances which aren't any more under discussion but which are still accessible as sources for ellipsis.

For example, before some question is posed the utterer has the goal: `obtain information` which leads him to carry out the action `ask question`. Once the question is posed the addressee's goal will be `answer question`, a subgoal of it can be `provide information`. If he needs extra information to answer the question his goals will be `obtain information` and the subsequent `ask question`. A possible goal also can be `reject question` if he doesn't want to discuss the issue, which can be achieved by saying it explicitly or by changing the topic. If he chooses one of the first two alternatives the question will be open until he achieves `answer question`. When this happens the utterer of the question will have achieved `obtain information` and the issue will be closed<sup>10</sup>. If the question is rejected it will be closed immediately. Examples like (8) are accounted for in this way:

- (8) > How long do you want to keep the movie?
- Is it closed on Sunday?
- > Yes.
- Then, until Monday.

### 4.2.3 Knowledge

Each CPs has a knowledge-base whose intersection are the Shared Beliefs. The communicative context as well as the information exchanged during the dialog are also part of the Shared Beliefs.

We agree with LuperFoy (1991) in the view that the information exchanged during the interaction must be kept separated from the rest of information in the knowledge base. There are several reasons for that. First of all, one may choose not to incorporate certain asserted propositions into his set of beliefs. And second, one needs to ground conceptually what is being talked about and make inferences on it upon the knowledge base, but one must still be able to distinguish what has been said during the discourse and what not. Keeping track conceptually of what has been said creates expectations about further utterances and decides on their interpretation. In our model this is accounted for in a straightforward way, since, as we will see, the entities in our discourse pool are the same kind of objects as those in the knowledge base. We assume that the objects in the discourse pool have a pointer to the corresponding objects in the knowledge-base, which makes all the facts holding of them available for inference.

The knowledge-base contains general knowledge of the world, domain knowledge and situational scripts. The communicative context is part of the knowledge

---

<sup>10</sup>This corresponds to the update/downdate of QUD in the grammar-based approach.

of the world. The knowledge is represented like a network where concepts and entities are linked to each other through relations.

We distinguish three kinds of fragments whose contextual dependence is in the knowledge-base (discourse pool, physical environment and the proper knowledge-base) and which may depend on the knowledge base for their resolution:

- when there is some salient entity in the pool of discourse entities about which the fragment says something or to which the remnant stands in some kind of relation upon the knowledge base (see (1));
- when there is some salient entity or action in the communicative context about which the fragment says something or to which the fragment stands in some kind of relation upon the knowledge base;

(9) Looking at a necklace: "So nice! How much?"

(10) Two persons in a room, one is hanging a picture on the wall, the other says: "Higher." (Hang) it higher.

- script-like situations: when the fragment has to be resolved with a salient issue provided by the communicative context and its associated goals upon the knowledge-base.

(11) Uttered by a customer at the travel agency: "Flights to Paris".

We can present a uniform account of this kind of fragments. In the first two cases we have to do with some semantic-conceptual representation, whose origin may be in the discourse or in the environment, which is in focus of attention and, thus, can be omitted. Further knowledge from the knowledge base allows to do the necessary inferences to resolve the fragment. In the third case it is the situational environment which activates some script in the knowledge-base, in which it is stated which goal associated with which issue the CPs pursues at that point. The issue associated with the goal is, thus, in focus of attention and can be elided. Since both representations of the contextual anchors and of the objects in the proper knowledge-base are mental representations, no interface problems arise. The linguistic input, the fragments themselves, are translated into semantic-conceptual representations and the result of the resolution is, of course, a semantic-conceptual (mental) representation.

## 5 Analysis and formalization

To formalize our notion of context dependency we will introduce two sub-features into the feature C(ON)T(E)XT: DISC(OURSE)-REC(ORD) and FOC(US-OF)-ATT(ENTION). We will also adopt the feature B(A)CKGR(OUN)D, proposed by Green (1996), with some modifications.

The feature DISC-REC will have as value a list of *ms(a)g(e)-sem(antic)-obj(ect)s*, a subtype of *sem(antic)-obj(ect)*. Figure 1 shows the hierarchy of *sem(antic)-obj(ect)s* with their feature-values specifications.

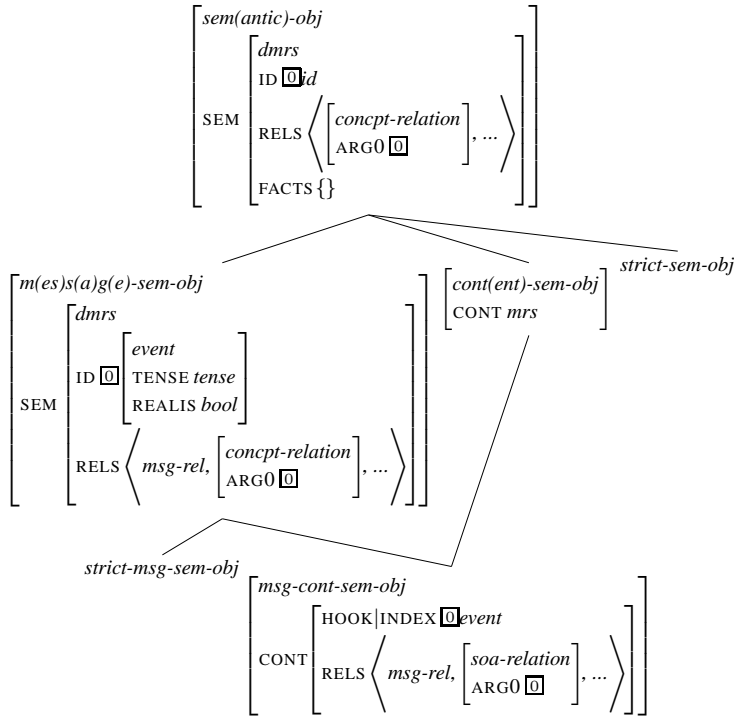

Figure 1: Type hierarchy of semantic objects

A d(eep)-mrs is a semantic-conceptual representation. We will express them in mrs-like format, but one has to keep in mind that there is no lexical or structural information in them. They are thoughts or mental representations of entities or events/states. The value of the feature ID(ENTIFIER) is similar to an index in a linguistic representation, but here it points to some individual/event in the knowledge sphere of the CP. The value for the feature REL(ATION)S is not a lexical predicate, but a conceptual predicate and the value of ARG0 is the entity which this predicate instantiates. The value of the feature FACTS is a possibly empty set of facts which hold of the semantic object in the knowledge base. If some utterance is grounded it means that it is matched against the knowledge base and all the facts holding of it and of the entities referred to in it are available for inference. *Sem-objs* is underspecified for semantic representations of entities/events in the knowledge-base, included those in the discourse pool and the situational environment, and representations of utterances in the discourse record. We have a subtype *strict-sem-obj* to designate those objects which are non-linguistic, i.e. those in SIT-OBJs.

The subtype *msg-sem-obj* is further specified to have as member of RELS a message relation and an ID of type event. This type corresponds to a full event/state mental representation. This kind of representations are the ones we have in the discourse-record when the structural form of the sentences is lost. This type has a further subtype *strict-msg-sem-obj*, about which we will say more when we talk

about open issues.

*Sem-cont-objs* have an additional feature CONT which has as value a semantic-structural representation and are, thus, still linguistic objects. The objects in the discourse pool which haven't lost their structural-lexical information will be of this type.

Finally, to the type *msg-cont-sem-obj* will belong the representations of recent utterances in the discourse-record which haven't lost their structural information yet. So the discourse-record will contain an ordered list of objects of the type *msg-sem-obj*, which is underspecified for semantic-conceptual representations and semantic-structural representations of sentences. The representation of older sentences will be a *msg-sem-obj*, not defined for the feature CONT, and newer sentences will be objects of the type *msg-cont-sem-obj*, which it is specified for the feature CONT.

The feature B(A)CKGR(OUN)D, as proposed by Green (1996), contains a set of true propositions which have to hold in the intersection of the beliefs systems of the CPs for a certain utterance to be pragmatically felicitous. The objects in BCKGRD are also of the type *sem-obj*. Within BCKGRD we will have two features for the dynamical sub-sets of the knowledge base, DISC(OURSE)-OBJ(ECT)S and SIT(UATIONAL)-OBJ(ECT)S. The first one will correspond to the pool of discourse objects. The value of DISC-OBJs will be a set of entities of the types *sem-obj* and *sem-cont-obj*, if they have been uttered recently. SIT-OBJs, on the other hand, contains a set of *strict-sem-objs* which are objects and actions in the communicative context and have no linguistic form. It also includes contextual indices. So we don't adopt the feature C-INDICES, and take its value to be part of our SIT-OBJs. The feature FACTS contains a set of pointers to the soas of the facts in BCKGRD which are available once the semantic-objects are matched against the knowledge-base.

DISC-REC, SIT-OBJs and DISC-OBJs contain the linguistic/mental representations in the context, to which the fragment can be anchored and which can be omitted.

The feature FOC-ATT will take, thus, as value an ordered list of *sem-objs* and fragments will be felicitous if their source, contextual anchor or some associated semantic-object upon the knowledge-base is the first element in the list. Fragments are also felicitous if there is a *msg-cont-sem-obj* in DISC-REC upon which they can be resolved.

## 5.1 Fragment analysis

We present a new dimension in the classification of fragments, **res(olution)-type**, based on their anchorage to the context and resolution type. We assume that this dimension will cross with the dimensions **msg-type** (with sub-types for the different types of messages), **frag-type** (distinguishing between modified and non-modified fragments) and **frag-arg-type** (with sub-types for the different syntactic categories of remnants and their function within the resolved sentence) similar to the ones

proposed in Schlangen (2003). The upper types in the four dimensions inherit from the general type *frag(ment)-cl(ause)*, whose specification is shown below. The hierarchy of fragment types in our dimension is shown in Figure 2.

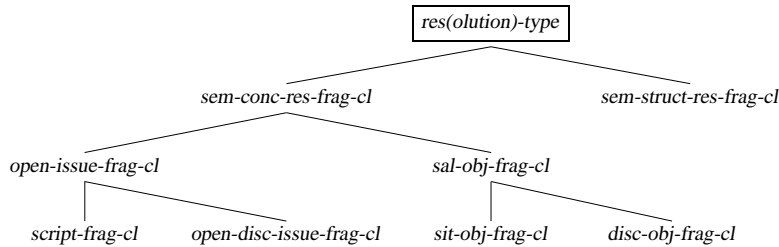

Figure 2: The **res-type** dimension

The general type *frag(ment)-cl(ause)*, which contains general specifications about the syntax and deep semantics of fragments and from which the types in the four dimensions inherit has the specification shown in (12). We introduce a new feature SEM in the sign, which stands for its semantic-conceptual representation<sup>11</sup>. What this supertype says is that there is a NON-HEAD-DTR which is linguistically realized, hence the specification for the feature SYNSEM. The type contributes a message and a soa-relation to the semantic-conceptual representation of the sentence. The mother, that is, the resolved fragment, is represented also at the semantic-conceptual level and has as value for the feature ID an event and for the feature RELS the relation contributed by the NON-HEAD-DTR and the relations contributed by C-SEM (a feature analogous to C-CONT in MRS).

$$(12) \left[ \begin{array}{l} \text{frag-cl} \\ \text{SEM} \left[ \begin{array}{l} \text{dmrs} \\ \text{ID} \quad \boxed{\text{event}} \\ \text{RELS} \quad \boxed{A} \oplus \boxed{B} \end{array} \right] \\ \text{C-SEM} \left[ \begin{array}{l} \text{dmrs} \\ \text{RELS} \quad \boxed{A} \left\langle \text{msg}, \left[ \begin{array}{l} \text{soa} \\ \text{RELN } \textit{soa-relation} \\ \text{ARG0} \quad \boxed{\text{event}} \end{array} \right] \dots \right\rangle \end{array} \right] \\ \text{NON-HEAD-DTRS} \left\langle \left[ \begin{array}{l} \text{sign} \\ \text{SYNSEM } \textit{synsem} \\ \text{SEM|RELS} \quad \boxed{B} \end{array} \right] \right\rangle \end{array} \right]$$

The sub-type *sem(antic)-struct(ural)-res(olution)-frag-cl* is further specified at the semantic-structural level as shown in (13). The mother gets the REL(ATIONS)S

<sup>11</sup>SEM is at the same level like SYNSEM because we assume that all signs have a meaning, however their surface realization may differ. Linguistic signs will be specified for the feature SYNSEM, but non-linguistic signs will be specified for a surface realization in a different modality. This is a first step towards having a unique format for the representation of the different modality signs which are employed in human communication.

and H(ANDLE)-CONS(TRAINTS) from the construction constraints and from the non-head-daughter. The G(LOBAL-)TOP has the same value as the label on an elementary predicate containing the message type and this, in turn, has as value for the feature SOA a handle which is *geq*<sup>12</sup> with the label of a soa, whose index, in turn, is the main index of the sentence. The feature CTXT contains a sub-feature DISC-REC which has as value a structural semantic-object of type *msg-cont-sem-obj* containing one elementary predicate, a soa-relation. We use the feature REL(ATIO)N as in Pollard and Sag (1994) and co-index the values of it for the soa-relation and the elementary predicate in the antecedent. We choose to represent the relation with a feature instead of being the type of the elementary predicate because this allows to say that both relations are of the same type, but without saying that they are the same event and have the same arguments.

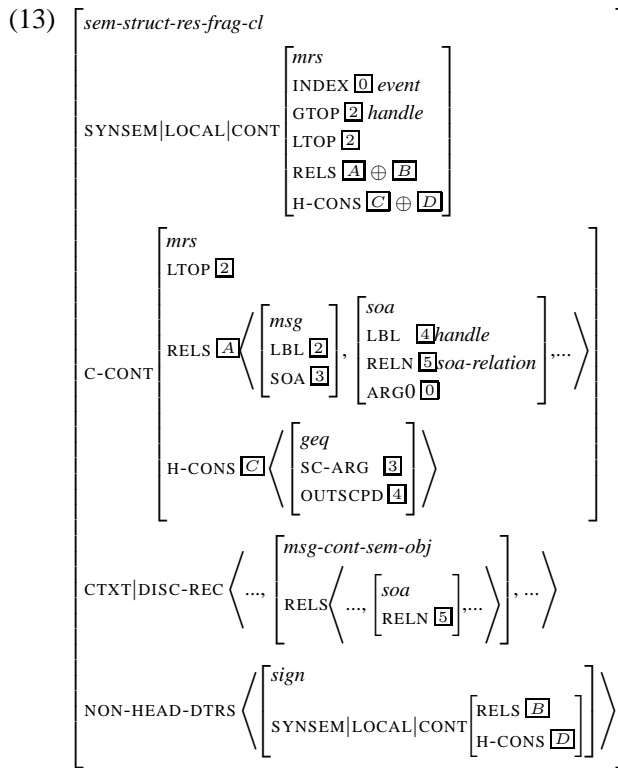

The other type of fragments that we have are resolved upon some representation in the focus of attention. The specification for the type *sem(antic)-conc(eptual)-res(olution)-frag-cl* is shown in (14). This supertype says that there is some object of type *sem-obj* in focus of attention whose value for RELS as well as the value for RELS of the remnant are shuffled with each other and belong to the RELS value of the mother together with the RELS provided by C-SEM.

<sup>12</sup>Greater or equal. See Schlangen (2003).

$$\begin{array}{l}
(14) \left[ \begin{array}{l}
\text{sem-conc-res-frag-cl} \\
\text{SEM} \left[ \begin{array}{l}
\text{dmrs} \\
\text{ID} \quad \boxed{0} \text{ event} \\
\text{RELS} \quad \boxed{A} \oplus \boxed{D} \text{ (where } \boxed{D} = \boxed{E} \oplus \boxed{B} \text{)}
\end{array} \right] \\
\text{C-SEM} \left[ \begin{array}{l}
\text{dmrs} \\
\text{RELS} \quad \boxed{A} \left\langle \text{msg}, \left[ \begin{array}{l}
\text{soa} \\
\text{RELN } \text{soa-relation} \\
\text{ARG0 } \boxed{0}
\end{array} \right] \dots \right\rangle
\end{array} \right] \\
\text{CTXT|FOC-ATT} \left\langle \left[ \begin{array}{l}
\text{sem-obj} \\
\text{SEM|RELS } \boxed{E}
\end{array} \right] \right\rangle \\
\text{NON-HEAD-DTRS} \left\langle \left[ \begin{array}{l}
\text{sign} \\
\text{SYNSEM } \text{synsem} \\
\text{SEM|RELS } \boxed{E}
\end{array} \right] \right\rangle
\end{array} \right] \\
\\
(15) \left[ \begin{array}{l}
\text{open-issue-frag-cl} \\
\text{SEM} \left[ \begin{array}{l}
\text{dmrs} \\
\text{ID} \quad \boxed{0} \text{ event} \\
\text{RELS} \quad \boxed{A} \oplus \boxed{D} \text{ (where } \boxed{D} = \boxed{E} \oplus \boxed{B} \wedge (\boxed{E} \equiv \boxed{F}) \text{)}
\end{array} \right] \\
\text{C-SEM} \left[ \begin{array}{l}
\text{dmrs} \\
\text{RELS} \quad \boxed{A} \left\langle \text{msg}, \boxed{F} \left[ \begin{array}{l}
\text{soa} \\
\text{RELN } \boxed{E} \text{soa-relation} \\
\text{ARG0 } \boxed{0}
\end{array} \right] \dots \right\rangle
\end{array} \right] \\
\text{CTXT|FOC-ATT} \left\langle \left[ \begin{array}{l}
\text{strict-msg-sem-obj} \\
\text{SEM|RELS} \left\langle \left[ \begin{array}{l}
\text{question-m-rel} \\
\text{PARAMS } \{ \boxed{1} \} \\
\text{MARG } \boxed{6}
\end{array} \right], \left[ \begin{array}{l}
\text{prpstn-m-rel} \\
\text{ARG0 } \boxed{6} \\
\text{MARG } \boxed{0}
\end{array} \right], \boxed{E} \left[ \begin{array}{l}
\text{soa} \\
\text{RELN } \boxed{E} \\
\text{ARG0 } \boxed{0}
\end{array} \right], \dots \right\rangle
\end{array} \right] \\
\text{NON-HEAD-DTRS} \left\langle \left[ \begin{array}{l}
\text{sign} \\
\text{SYNSEM } \text{synsem} \\
\text{SEM} \left[ \begin{array}{l}
\text{ID } \boxed{1} \\
\text{RELS } \boxed{E}
\end{array} \right]
\end{array} \right] \right\rangle
\end{array} \right]
\end{array}
\end{array}$$

A sub-type of this type is the *open-issue-frag-cl*, shown in (15), which will account for open questions which have been overtly expressed in the discourse, more general open issues of discussion, and issues which are relevant in the current situation. The type *open-issue-frag-cl* is specified to have a *strict-msg-sem-obj*, concretely a question, in the focus of attention. We have chosen the type *strict-msg-sem-obj* as the value of FOC-ATT because we want to prevent fragments whose semantic-structural representation is still in memory to resolve in this way<sup>13</sup>. The remnant corresponds to the abstract parameter in the question and the question provides the soa-relation with which the fragment is to be resolved. This is achieved by stating equivalence between the soa-relation in the question and the soa-relation

<sup>13</sup>However, we may add a further sub-type under *sem-struct-res-frag-cl* with a specification that both soa-rels, in DIS-REC and in C-CONT are equivalent. We leave this issue open for the moment.



provided by C-SEM. We adhere to the traditional analysis of questions, also adopted in Ginzburg and Sag (2001), in which a question contains a proposition<sup>14</sup>.

The further sub-type *open-disc(ourse)-issue-frag-cl* will add the specification that the question has been uttered in the preceding discourse. Resolution of the fragment is achieved via-identity. It will account for fragments like (8).

$$(16) \left[ \begin{array}{l} \textit{open-disc(ourse)-issue-frag-cl} \\ \text{CTXT} \left[ \begin{array}{l} \text{DISC-REC} \langle \dots, \boxed{7}, \dots \rangle \\ \text{FOC-ATT} \langle \boxed{7}, \dots \rangle \end{array} \right] \end{array} \right]$$

$$(17) \left[ \begin{array}{l} \textit{script-frag-cl} \\ \text{FOC-ATT} \langle \text{SEM|RELS} \boxed{17} \rangle \\ \text{BCKGRD|SIT-OBJS} \left[ \begin{array}{l} \textit{sem-obj} \\ \text{SEM} \left[ \begin{array}{l} \text{ID} \boxed{10} \\ \text{RELS} \textit{utterance} \end{array} \right], \left[ \begin{array}{l} \textit{sem-obj} \\ \text{SEM} \left[ \begin{array}{l} \text{ID} \boxed{8} \\ \text{RELS|RELN} \textit{utterer} \end{array} \right], \left[ \begin{array}{l} \textit{sem-obj} \\ \text{SEM} \left[ \begin{array}{l} \text{ID} \boxed{6} \\ \text{RELS} | \text{RELN} \textit{addressee} \end{array} \right] \end{array} \right] \\ \textit{sem-obj} \\ \text{SEM} \left[ \begin{array}{l} \text{ID} \boxed{10} \\ \text{RELS} \left[ \begin{array}{l} \text{RELN} \boxed{10} \textit{location} \\ \text{ARG1} \boxed{0} \end{array} \right] \end{array} \right] \\ \text{FACTS} \left\{ \left[ \begin{array}{l} \textit{generic-soa} \\ \text{RELN} \textit{have} \\ \text{ARG1} \boxed{7} \oplus \boxed{7} \\ \text{ARG2} \boxed{7} \textit{goal} \\ \text{ARG3} \boxed{7} \end{array} \right] \wedge \left[ \begin{array}{l} \textit{generic-soa} \\ \text{RELN} \boxed{7} \\ \text{ARG1} \boxed{17} \end{array} \right], \dots \right\} \\ \textit{sem-obj} \\ \text{SEM} \left[ \begin{array}{l} \text{ID} \boxed{8} \\ \text{RELS|RELN} \boxed{7} \textit{rol1} \end{array} \right], \left[ \begin{array}{l} \textit{sem-obj} \\ \text{SEM} \left[ \begin{array}{l} \text{ID} \boxed{6} \\ \text{RELS|RELN} \boxed{7} \textit{rol2} \end{array} \right] \\ \text{FACTS} \left\{ \boxed{13} \wedge \boxed{14}, \dots \right\} \end{array} \right] \end{array} \right] \end{array} \right]$$

The subtype *script-frag-cl* will account for cases like in (3) and (11). What these fragments have in common is that they are uttered in situations in which the CPs are committed to a joint action. Each CP plays a different role and each role has associated with it different goals, but these goals are complementary<sup>15</sup>. This kind of tasks are prototypical and their associated action plan is part of our knowledge-base. Our approach is to state that the location of the interaction and the roles of the CPs in it, both semantic-objects in SIT-OBJS, activate some script in the knowledge base. This is formalized by means of the feature FACTS of the semantic

<sup>14</sup>In MRS question-relations do not contain a PARAMS feature, but a *which-rel* which has the same index as an abstract relation (*place-rel*, *person-rel*). Since our representation is a non-linguistic semantic representation we need this feature to express abstraction. We will also adopt the feature M(AIN)ARG(UMENT) which in MRS has as value a label, however here it will have as value the value of the ARG0 of the relation taken as argument, since we don't have labels. We think that at this level of representation we don't have scope ambiguities, so we don't need labels to underspecify these ambiguities.

<sup>15</sup>For example, in a shop the shop-assistant's goal is to sell something to the customer and the customer's goal is to buy something from the shop-assistant.

objects. This feature has as value a set of pointers to the soas of asserted facts in the knowledge-base. These soas are generic in the sense that they don't say anything about individuals, but about conceptual predicates. They are assertions about classes. If we take predicates to denote sets, then, the arguments of these generic-soas are all individuals which, upon the knowledge-base, are members of a certain set. In our analysis the arguments of generic-soas will be the values of the feature RELN. The location of the interaction and the roles of the CPs will have some facts associated with them which can be paraphrased as follows: "In such a location where the CPs play each a certain role the CPs will have at that point a common goal. This goal has as argument a certain semantic object". Goals exist respect to some semantic object. This semantic object corresponds in this case to a question which will be in focus of attention, since it is associated with the current goal of the CPs upon the knowledge-base. The goal itself will be a relation underspecified for the particular goals of the CPs, since, as explained before, each one has a particular goal corresponding to the role he plays, but these goals are complementary. The argument of their particular goals will be the same, that is, the question in focus of attention<sup>16</sup>. For the rest, this type behaves like its supertype *open-issue-frag-cl* and the remnant corresponds to the parameter, which depending on the role of the utterer, will be provided or asked for.

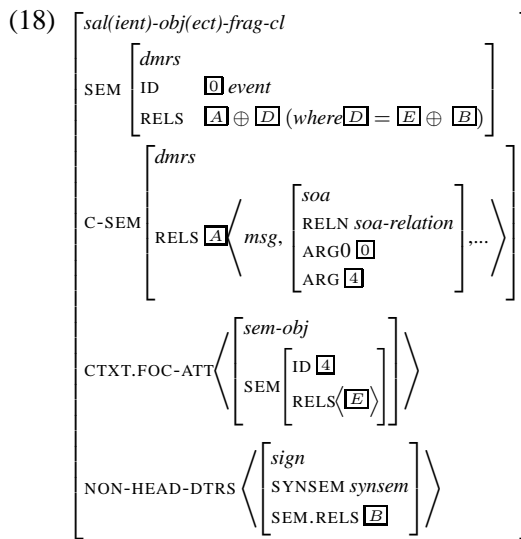

The type *sal(ient)-obj(ect)-frag-cl*, shown in (18), is a supertype which accounts for fragments which are contextually anchored to an entity, previously introduced in the discourse or present in the communicative context, to which the remnant stands in some kind of relation. Fragments like the ones in (1), (9) and (10) are accounted by sub-types of this type. Fragments like (1) can be resolved by inference upon the knowledge-base, as we will show below. However, fragments

<sup>16</sup>For example, in a taxi, the taxi-driver will have the goal obtain parameter(where to go?), while the customer will have the goal provide parameter(where to go?).

like (9) and (10), where the remnant provides an adjective predicated of the anchor or an adverb modifying the action in focus of attention, respectively, cannot be resolved like this. The type says that there is a semantic-object in the focus of attention which is an argument of the *soa*-relation with which the fragment is resolved. Both the relations of this semantic-object and of the remnant are part of the semantics of the mother, together with the semantics provided by C-SEM.

The sub-types *sit(uation)-obj(ect)-frag-cl* and *disc(ourse)-obj(ect)-frag-cl*, presented in (19), further specify the semantic-object in focus of attention to be an element of SIT-OBJS and to be of type *strict-sem-obj*, and an element of DISC-OBJS, respectively.

$$(19) \left[ \begin{array}{l} \textit{sit(uation)-obj(ect)-frag-cl} \\ \text{CTXT} \left[ \begin{array}{l} \text{FOC-ATT} \langle \boxed{6}, \dots \rangle \\ \text{SIT-OBJS} \{ \boxed{6}, \dots \} \end{array} \right] \end{array} \right] \quad \left[ \begin{array}{l} \textit{disc(ourse)-obj(ect)-frag-cl} \\ \text{CTXT} \left[ \begin{array}{l} \text{FOC-ATT} \langle \boxed{6}, \dots \rangle \\ \text{DISC-OBJS} \{ \boxed{6}, \dots \} \end{array} \right] \end{array} \right]$$

$$(20) \left[ \begin{array}{l} \textit{disc-obj-nm-np-frag-cl} \\ \text{C-SEM} \left[ \begin{array}{l} \text{RELS} \langle \textit{msg}, \left[ \begin{array}{l} \textit{soa} \\ \text{RELN} \boxed{7} \textit{soa-relation} \\ \text{ARGA} \boxed{4} \\ \text{ARGB} \boxed{1} \end{array} \right], \dots \rangle \end{array} \right] \\ \text{CTXT} \left[ \begin{array}{l} \text{FOC-ATT} \langle \boxed{6} \rangle \\ \text{SEM} \left[ \begin{array}{l} \textit{sem-obj} \\ \text{ID} \boxed{4} \\ \text{RELS} \langle \text{RELN} \boxed{F} \rangle \\ \text{FACTS} \left\{ \left[ \begin{array}{l} \textit{soa} \\ \text{RELN} \boxed{7} \\ \text{ARGA} \boxed{F} \\ \text{ARGB} \boxed{G} \end{array} \right], \dots \right\} \end{array} \right] \end{array} \right] \\ \text{DISC-OBJS} \{ \boxed{6}, \dots \} \end{array} \right] \\ \text{NON-HEAD-DTRS} \left[ \begin{array}{l} \textit{sign} \\ \text{SYNSEM} \textit{synsem} \\ \text{SEM} \left[ \begin{array}{l} \text{ID} \boxed{1} \\ \text{RELS} \langle \text{RELN} \boxed{G} \rangle \\ \text{FACTS} \{ \boxed{5}, \dots \} \end{array} \right] \end{array} \right] \end{array} \right]$$

The type *disc-obj-nm-np-frag-cl* how resolution upon the knowledge-base is modeled. We lack empirical evidence for deciding whether this kind of resolution is introduced in this specific type or in a more general type. At the moment all fragments encountered in which this kind of resolution is required where syntactically NPs and the anchor was previously introduced in the discourse. For illustrative purposes we will present the formalization of this type of resolution within a more specific type which is the result of crossing the types *np-frag-cl*, *non-mod-frag-cl* and *disc-obj-frag-cl*. This type accounts for the fragment in (1).

The semantic-object in focus of attention is an element of DISC-OBJS and has in its set of FACTS a pointer to a generic-*soa* in the knowledge-base in which it is

asserted that between the concept of which this semantic-object is an instance and the conceptual relation instantiated by the remnant holds a relation. This relation will be the value of the feature RELN in the soa with which the fragment is resolved. Both the anchor and the remnant are arguments of this soa-relation<sup>17</sup>.

## 6 Conclusion

In this paper we have discussed two previous approaches to the analysis of fragments: a grammar-based one and a coherence-based one. With the former we share the view that the use of fragments must be constrained from within the grammar. However, the discourse-structure assumed in this theory is very rigid and doesn't fully predict which previous utterances are accessible for ellipsis resolution. With the later approach we agree on the view that there are two kinds of ellipsis resolution: *via-identity* and *via-inference*. However, in this approach, as well as in the grammar-based one, the output of resolution is always a semantic-structural representation. This is in our view not always possible, since in fragments requiring some inference to be done, certain pieces of meaning have never been uttered and, thus, there is no linguistic semantic-structural representation of them at all. Moreover, when there is a long distance between source and fragment structural information may not be any more available for resolution. Unlike these approaches we are in favor of a treatment of remnants as non-head daughters, and against the existence of syntactic parallelism.

We model accessibility for ellipsis resolution *via-identity* by means of a discourse-record and the focus of attention. The discourse-record is a memory buffer containing different level representations of previous utterances. The structural representation is rapidly forgotten, while the semantic-conceptual representation remains longer in memory. Utterances whose semantic-structural representation is still in memory are accessible for ellipsis resolution. On the other hand, the discourse goals determine whether the topic addressed by a certain utterance is still open, in which case it may be in focus of attention and available for ellipsis resolution.

The contextual anchors of fragments which are resolved *via-inference* are semantic-objects either in the discourse-pool or in the physical environment, the dynamic sub-sets of the CP's Shared Beliefs. When these objects are in focus of attention, knowledge about them is activated, which allows to infer their relation to the remnant of the fragment.

## References

Alcántara, Manuel and Bertomeu, Núria. 2005. Ellipsis in Spontaneous Spoken

---

<sup>17</sup>For example, if upon the knowledge-base the relation between musicians and prizes is *obtain*, the fragment is resolved "obtain(Anastacia, prizes)", since the knowledge-base also contains the assertion that Anastacia is a musician.

- Language. In Petra Hendrix and Jennifer Spenader (eds.), *Workshop on Cross-modular Approaches to Ellipsis*, ESSLLI 2005, Edinburgh.
- Carberry, Sandra. 1985. A pragmatics-based approach to understanding intersentential ellipsis. In *Proceedings of the 23rd annual meeting on Association for Computational Linguistics*.
- Crocker, Matthew W. 1999. Mechanisms for sentence processing. In Garrod and Pickering (eds.), *Language Processing*, Psychology Press.
- Ginzburg, Jonathan. 1997. *A Semantics for Interaction in Dialogue*, Chapter 6: Querying and Assertion in Dialogue, II: defeasible presuppositions, fact ellipsis, and non-cooperativity. forthcoming from CSLI Publications and University of Chicago Press.
- Ginzburg, Jonathan and Sag, Ivan A. 2001. *Interrogative investigations, the form meaning and use of English interrogatives..* CSLI Publications.
- Ginzburg, Jonathan, Sag, Ivan A. and Purver, Matthew. 2003. *Perspectives on Dialogue in the New Millennium*, volume 114 of *Pragmatics Beyond, New Series*, Chapter Integrating Conversational Move Types in the Grammar of Conversation, pages 25–42. John Benjamins.
- Green, Georgia M. 1996. The structure of CONTEXT: The representation of pragmatic restrictions in HPSG. In James Yoon (ed.), *Proceedings of the 5th annual meeting of the Formal Linguistics Society of the Midwest*, Studies in the Linguistic Sciences.
- Gregory, Howard and Lappin, Shalom. 1997. A computational model of ellipsis resolution. In *Proceedings of the Conference on Formal Grammar*, ESSLLI 1997, Aix-en-Provence.
- Kintsch, W. and van Dijk, T.A. 1978. Toward a model of text comprehension and production. *Psychology Review* 85.
- LuperFoy, Susann. 1991. *Discourse pegs: A computational analysis of context-dependent referring expressions*. Ph. D.thesis, The University of Texas at Austin.
- Pollard, Carl and Sag, Ivan A. 1994. *Head-driven Phrase Structure Grammar*. University Chicago Press.
- Schlangen, David. 2003. *A Coherence-Based Approach to the Interpretation of Non-Sentential Utterances in Dialogue..* Ph. D.thesis, Institute for Communication and Collaborative Systems, School of Informatics, University of Edinburgh.
- Wierzbicka, Anna. 1988. *The semantics of grammar*, volume 18 of *Studies in Language Companion Series*. John Benjamins.

# The Tswana infinitive as a mixed category

Denis Creissels 

Université Lyon 2

Danièle Godard 

CNRS et U. Paris 7

Proceedings of the 12th International Conference on  
Head-Driven Phrase Structure Grammar

Department of Informatics, University of Lisbon

Stefan Müller (Editor)

2005

Stanford, CA: CSLI Publications

pages 70–90

Creissels, Denis & Danièle Godard. 2005. The Tswana infinitive as a mixed category. In Stefan Müller (ed.), *Proceedings of the 12th International Conference on Head-Driven Phrase Structure Grammar, Department of Informatics, University of Lisbon*, 70–90. Stanford, CA: CSLI Publications. DOI: 10.21248/hpsg.2005.4.



## Abstract

After studying the morphological and syntactic properties of Tswana infinitives in some detail, we argue that a mixed category approach is more adequate than a phrasal approach to account for the combination of their common properties with the two different uses they are found in.

## 1 Introduction

Expressions which, like English verbal gerunds, share properties with both nouns and verbs have received renewed attention recently. There is a debate concerning the best way to represent their mixed properties: one possibility is to rely on phrase structures characterized by category switch (Pullum 1991), possibly enriched with functional structure sharing (Bresnan 1997); another one is to set up a new category (head value), which is neither verb nor noun, but inherits from less specified nominal and verbal categories at the same time (Malouf 2000). We think that the question cannot be solved without a detailed examination of specific phenomena. We argue here that the Tswana infinitive favors the mixed category analysis, because it combines a unique mixed morphology with two different uses (called here ‘nominal’ and ‘verbal’) of the form.<sup>1</sup>

## 2 The Properties of Tswana Infinitives

### 2.1 Mixed morphology

In all of its uses, the Tswana infinitive has the same mixed morphology, exhibiting both verbal and nominal properties.

It patterns like a verb with respect to the three following properties:<sup>2</sup>

(i) It shows the same TAM distinctions (tense-aspect-modalities) as an indicative: it is inflected for the *present / perfect / future / potential / continuative*.

(ii) It shows the same polarity distinctions: *positive / negative*.

We give some examples in (1)-(3):

---

<sup>1</sup> Tswana (Setswana) is a Bantu language spoken by 4 million speakers in Botswana and South Africa.

<sup>2</sup> APPL= applicative; CAUS= causative; DEM= demonstrative; FIN= final vowel; GEN= genitive; INF= infinitive; LK= linker; LOC= locative; NEG= negative; O1S= 1pSg object agreement index, etc. O3:X= 3rdp index agreeing with n-class X; PFT= perfect; POT= potential; PRO1S= 1stpSg pronoun, etc.; PRO3:X= 3rdp pronoun, agreeing with NCLASS X; PSV= passive; S1S= 1stp subject agreement index, etc.; S3:X= 3rdp subject index, agreeing with n-class X, SEQ: sequential.

- (1)a. *o lema*  
 ú- lím-á  
 S3:1-plough-FIN  
 ‘(s)he ploughs / is ploughing’
- b. *go lema*  
 χù- lím-à  
 INF-plough-FIN  
 ‘to plough’
- (2)a. *ga a leme*  
 χá-a- lím-í  
 NEG-S3:1-plough-FIN  
 ‘(s)he does not plough / is not ploughing’
- b. *go sa leme*  
 χù-sá- lím-í  
 INF-NEG-plough-FIN  
 ‘not to plough’
- (3)a. *o ka lema*  
 ú-ká- lím-à  
 S3:1-POT-plough-FIN  
 ‘(s)he can / may plough’
- b. *go ka lema*  
 χù-ká- lím-à  
 INF-POT-plough-FIN  
 ‘to be able to plough’

(iii) It can include object markers exactly in the same way as verb forms.

- (4)a. *ke e lema*  
 kí-i- lím-à  
 S1S-O3:9-plough-FIN  
 ‘I plough / am ploughing it’
- b. *go e lema*  
 χù-i- lím-à  
 INF-O3:9-plough-FIN  
 ‘to plough it’

And it patterns like nouns with respect to the following three properties:

(iv) The initial syllable *go-* is a noun class prefix (15), as is made clear by nominal dependents: they take a prefix (for the demonstrative and the genitive), or a linker (for the relative clause), or both a prefix and a linker (for the adjective) which agree with the prefix *go-*.

- (5)a. *mosadi yo moša*                      mò-sádi jó              mò-ǰá  
 ‘new woman’                              1-woman 1.LK 1-new
- b. *go bina mo goša*                      χù-      bín-à              mo χù-ǰá  
 ‘new dance /dancing’                      INF/15-danser-FIN 15.LK 15-new

(v) The locative suffix -ng [ŋ] can be attached to them.

- (6) *Mo [go akanyeng mo ga gagwe]*  
 mó      χù-ákáŋ-e-ŋ              mo      χá-χáχwé  
 PREP INF-think-FIN-LOC 15.DEM 15.GEN-PRO3:1  
*ga a a lemoga                      fa              o sa dire                      tiro              sentle*  
 NEG-S1S-PFT-notice-FIN COMP S3:1-NEG-do-FIN 9.work 7-good  
 ‘While he was thinking in this way (lit. in this thinking of him) he did not notice that he was not doing the work properly’



(vi) They cannot include a subject marker.

- (7) *[Go (\*ba) nwa bojalwa mo mebileng]*  
 χ̣ù-nw-á bú-dzálwá mó mí-bìlé-ŋ  
 INF-drink-FIN 14-beer PREP 4-street-LOC  
*ga go a siama* NEG-S3:15-PFT-be.good-FIN  
 ‘It is not good (for them) to drink beer in the streets’

These properties are summarized as follows:

(8)

verbal morphology	nominal morphology
tam markers	n-class prefix
polarity marker	locative suffix
(possible) object markers	no subject marker

Even in the nominal uses, the infinitive shows the same tam inflection as a verb. In this, Tswana contrasts with the cognate Bantu language Kikuyu, whose infinitives have an impoverished morphology (Mugane 2003).

## 2.2 Syntactic properties common to all uses

All uses of the Tswana infinitive share the following two properties:

(i) The phrase it heads cannot contain a subject NP. In this, of course, the infinitive contrasts sharply with verb forms, such as the indicative:

- (9)a. *Basadi \*(ba) nwa bojalwa mo mebileng*  
 bà-sádí bá-nw-á bú-dzálwá mó mí-bìlé-ŋ  
 2-woman S3:2-drink-FIN 14-beer PREP 4-street-LOC  
 ‘Women drink beer in the streets’
- b. *\*[Go nwa bojalwa Basadi mo mebileng]*  
 χ̣ù-nw-á bú-dzálwá bà-sádí mó mí-bìlé-ŋ  
 INF-drink-FIN 14-beer 2-woman PREP 4-street-LOC  
*ga go a siama* NEG-S3:15-PFT-be.good-FIN  
 ‘Women drinking beer in the streets is not proper’
- c. *\*[Basadi go nwa bojalwa mo mebileng]*

This property is unexpected, given the Deverbalization Hierarchy, well-supported cross-linguistically (see Malouf 2000: 96, commenting on Croft 1991), which says that, if a form inflects for tam like a verb, it also takes direct arguments (including the subject) like a verb. However, Tswana does not represent a true counter-example to this generalization, since the impossibility of a subject can be traced to a conflict between its morphology and the requirement that the occurrence of a subject be correlated with a subject marker on the verb. As illustrated in (9a), the sentence is ungrammatical if the verb form does not contain the marker *ba*. We note this requirement with the following implicational constraint:

(10) [SUBJ <canonical-synsem-i >] => [MORPHIFORM < ..., aff-i , ...>]

On the other hand, the subject marker cannot be present on the infinitive (7). Although Tswana verbal morphology results from a complex function taking into account a number of different properties, and cannot be said to be concatenative (Creissels 2005), it is realized as a template, where the n-class prefix *go-* occupies the same slot as the subject affix marker would. If this is the case, there is no way that constraint (10) can be satisfied, and the impossibility of a subject NP in a infinitival phrase follows.

(ii) An infinitival phrase includes the same dependents as the corresponding verb (excluding the subject). Thus, the infinitive combines with an object NP, locatives, PP not marked by a linker (Tswana nouns do not take PP complements), and adverbs. This is the case even in the presence of nominal dependents, such as an adjective, a genitive or a demonstrative. Example (10) illustrates the co-occurrence of an object NP (*nama*) with a demonstrative (*mo*), a genitive (*ga gago*) and an adjective (*goša*). Example (11) illustrates the co-occurrence of an object NP and an adjective.

(10) *Ke rata [go apaya nama*  
*kì-rát-á      χù-ápáj-à      nàmà*  
 S1S-like-FIN    INF-cook-FIN    9.meat  
*mo ga gago mo goša]*  
*mó      χá-χáχù      mó      χù-ǰá*  
 15.DEM    15.GEN-PRO2S    15.LK    15-new  
 ‘I like this new way you have to cook meat’

(11) *go-lets-a katara mo go-ntle*  
*χù-lìts-à      katará      mó      χù-ntle*  
 INF-cry.CAUS-FIN    guitar    15.LK    15-nice  
 ‘a nice guitar playing’

It is worth noting immediately that nominal and verbal dependents are interspersed. For instance, in (12), the genitive occurs between two verbal dependents, the object NP and the PP.

(12) *Ga ke rate*  
 NEG-S1S-like-FIN  
*[go nwa bojalwa ga basadi mo mebileng]*  
*χù-nw-á      bú-dǰalwa      χá-bà-sádí      mó      mí-bìlé-ṅ*  
 INF-drink-FIN    14-beer      15.GEN-2-woman    PREP    4-street-LOC  
 ‘I do not like women’s drinking beer in the streets’

In this respect, Tswana infinitives contrast with the well-known case of English gerunds, but they are not isolated. Not only is it the case for infinitives in other Bantu languages (see Kikuyu, Mugane 2003), but also

in West African languages (see Dagaare, Bresnan 1997). We come back to this property in section 3, since it has played a role in the discussion concerning the best way (phrasal or lexical) to represent such hybrid expressions.

### 2.3 The nominal use of the infinitive

As is the case for several other Bantu languages, Tswana infinitives are found in two types of uses, ‘nominal’ and ‘verbal’ (see a detailed discussion of Xhosa in du Plessis 1982, Visser 1989, du Plessis and Visser 1992, of Kikuyu in Mugane 2003, and a brief presentation of Tswana in Creissels 2003). Each is characterized by a set of correlated properties, which clearly contrast the two uses. We begin with nominal infinitives:

(i) They may include nominal dependents; we have already seen genitives (10)-(12), adjectives (5b), (10), and demonstratives (10) in preceding examples; we illustrate the relative clause in (13):

- (13) *go bina mo ke go ratang*  
 χù-bín-à mó kí-χù-rát-à-ŋ  
 INF-danser-FIN 15.LK S1S-O3:15-like-FIN-REL  
 ‘a dance I like’

(ii) They assume all the grammatical functions in which one finds NPs: subject (9b), object (10), (12), genitive (14), complement of a preposition (6), (15).

- (14) *nako [ya go goroga ga baeng]*  
 nākò já-χú-χóŋχ-à χá-bá-éŋ  
 9.time 9.GEN-INF-arrive-FIN 15.GEN-2-guest  
 ‘the time of the arrival of the guests’

- (15) *Ba ne ba utlwa [ka [go koma ga gagwe]]*  
 bá-nè bà-útlw-à ka χù-kóm-à χá-χáχwé  
 S3:2-AUX S3:2.SEQ-feel-FIN PREP INF-moan-FIN 15.GEN-PRO3:1  
*gore o lwala thata* COMP S3:1-be sick-FIN very  
 ‘They felt from his moaning that he was very sick’

(iii) What is understood as the first argument is realized as a genitive or unrealized, in which case it has an arbitrary or pragmatic interpretation (16): it is neither controlled nor raised. Thus, in (6) the genitive pronoun *ga gagwe* is obligatory to get the interpretation where the first argument of the infinitive is co-indexed with the matrix subject.

- (16) *[Go mpotsa] go a ntapisa.*  
 χṽ-m-púts-a χṽ-á-n-táp-is-à  
 INF-O1S-ask-FIN S3:15-DJT-O1S-be tired-CAUS-FIN  
 Questioning makes me tired  
 ‘It’s tiring that people ask (me) questions’

(iv) When used as object NPs, they observe the same linearization constraint as ordinary objects: they cannot be separated from the V.

- (17)a *Ke itse monna yo sentle.*  
 kí-íts-í mù-nná jó sí-ntlè  
 S1S-know-FIN 1-man 1.DEM 7-good  
 ‘I know this man well’

b. \**Ke itse sentle monna yo.*

- (18)a *O rata [go letsa katara mo ga gago] thata.*  
 ú-rát-à χṽ-líts-à kátará mó χá-χáχṽ t<sup>h</sup>átà  
 S3:1-like-FIN INF-cry.CAUS-FIN 9.guitar 15.DEM 15.GEN-PRO2S  
 much  
 lit. He likes this playing (the) guitar of yours very much  
 ‘He likes your playing the guitar a lot’

b. \**O rata thata [go letsa katara mo ga gago].*

(v) When used as object NPs with intransitive verbs, they trigger the applicative form, like ordinary NPs. The applicative *el* affix is boldface.

- (19)a *O **gakgamalela** bopelokgale jwa mosimanee.*  
 ú-χáq<sup>h</sup>amál-èl-à bú-pílúq<sup>h</sup>áǎlì dǎwá-mò-símàní  
 S3:1-be surprised-APPL-FIN 14-courage 14.GEN-1-boy  
 ‘He is surprised by the courage of the boy’

b. \**O gakgamala bopelokgale jwa mosimanee.*

- (20)a *O **gakgamalela** [go bua Setswana ga Lekgoa le].*  
 ú-χáq<sup>h</sup>amál-èl-à χṽ-bú-á sí-tswana  
 S3:1-be surprised-APPL-FIN INF-speak-FIN 7-Tswana  
 χá-lì-q<sup>h</sup>úà lé  
 15.GEN-5-European 5.DEM  
 lit. He is surprised by the speaking Tswana of this European  
 ‘He is surprised by the fact that this European speaks Tswana’

b. \**O gakgamala [go bua Setswana ga Lekgoa le].*

(vi) They can be pronominalized in the same way as ordinary NPs. In particular, they give rise to the object affix appropriate for n-class 15.

- (21) *A o utlule [go bua Setswana ga Lekgoa le] ?*  
 INTER S2S-hear-PFT-FIN INF-speak-FIN 7-Tswana 15.GEN-5-  
 European 5.DEM  
 –*Ee, ke go utlule.*  
 èè kǐ-χù-utlù-l-è  
 yes, S1S-O3:15-hear-PFT-FIN  
 ‘Did you hear this European speak Tswana ? – Yes, I heard it’

## 2.4 The verbal use of the infinitive

On all these aspects, the verbal use of Tswana infinitives, characterized by the following correlated properties, contrasts with the nominal one.

- (i) They do not include nominal dependents.  
 (ii) They are either subject or object of verbs, or purpose modifiers; in these functions, they may alternate with *gore* finite clauses. Thus, the *gore* clause in (22b) is possible in the same environment as the verbal infinitive (no genitive), while the nominal infinitive is excluded (22c).

- (22)a *Re aga maraka [go sireletsa dikgomo mo dibataneng].*  
 rǐ-áχ-á ma-raká χù-síreléts-à ðǐ-q<sup>h</sup>òmú mó ðǐ-bàtànè-ǐ  
 S1P-build-FIN 6-kraal INF-protect-FIN 8/10-cow PREP 8/10-beast  
 of prey-LOC  
 ‘We build kraals so as to protect cows from beasts of prey’
- b. *Re aga maraka [gore dikgomo di sirelediwe mo dibataneng].*  
 rǐ-áχ-á ma-raká χùrǐ ðǐ-q<sup>h</sup>òmú ðǐ-sírelèd-ìw-é  
 S1P-build-FIN 6-kraal COMP 8/10-cow S3:8/10-protect-PSV-FIN  
 mo ðǐ-bàtànè-ǐ  
 ‘We build kraals so that cows are protected from beasts of prey’
- c. \* *Re aga maraka [go sirelediwa ga dikgomo mo dibataneng].*  
 S1P-build-FIN 6-kraal INF-protect-PSV-FIN 8/10-cow PREP 8/10-  
 beast of prey-LOC

- (iii) The subject is never realized; it is controlled (23a) or raised (23b).<sup>3</sup>

- (23)a *O rata [go letsa katarà].*  
 ú-rát-á χù-łits-à kàtárà  
 S3:1-like-FIN INF-cry.CAUS-FIN 9.guitar  
 ‘He likes playing (the) guitar’

<sup>3</sup> We cannot exclude, at this stage, that the subject of a verbal infinitive can also be pragmatically interpreted. The subject of a nominal infinitive still differs in that it cannot be controlled or raised.

- b. *Ba mo leta [go goroga].*  
 bá-mú-lít-á χύ-χόρòχ-à  
 S3:2-O3:1-wait-FIN INF-arrive-FIN  
 ‘They are waiting for him to arrive’

(iv) It can be separated from the V, even when it is the complement of the verb, in the same way as a clause introduced by the complementizer *gore*.

- (24)a *O rata thata [go letsa katara].*  
 ú-rát-à t<sup>h</sup>átá χύ-líts-à kàtárà  
 S3:1-like-FIN much INF-cry.CAUS-FIN 9.guitar  
 ‘He likes very much playing (the) guitar’

- b. *Ke itse sentle [gore Mpho o tsamaile].*  
 kí-ítsí sí-ntlé χóri mp<sup>h</sup>ó ú-tsámà-ìl-è  
 S1S-know-FIN 7-good COMP 1.Mpho S3:1-go away-PFT-FIN  
 ‘I know well that Mpho has gone’

(v) They can be complements of intransitives without obligatorily triggering the applicative form, like *gore* clauses.

- (25)a *O gakgamala [go utlwa Lekgoa le mmuisa ka Setswana].*  
 ú-χáq<sup>h</sup>ámál-à χύ-útlw-á lí-q<sup>h</sup>úá  
 S3:1-be surprised-FIN INF-hear-FIN 5-European  
 lí-m-mú-ís-á ká sí-tswánà  
 S3:5-O3:1-speak-CAUS-FIN PREP 7-Tswana  
 ‘He is surprised to hear the European speaking to him in Tswana’

- b. *O gakgamala [gore Lekgoa le le bua Setswana].*  
 ú-χáq<sup>h</sup>ámál-à χóri lí-q<sup>h</sup>úá lé lí-bú-á sí-tswánà  
 S3:1-be surprised-FIN COMP 5-European 5.DEM S3:5-parler-FIN 7-  
 tswana  
 ‘He is surprised that this European speaks Tswana’

(vi) They cannot be represented by an object affix on the verb, like *gore* clauses.

- (26)a *A o rata [go letsa katara]?*  
 –Ee, \*o go rata thata.  
 èè \*ú-χύ-rát-à t<sup>h</sup>átá  
 yes S3:1-O3:15-like-FIN much  
 ‘Does he likes playing (the) guitar? –Yes, he likes it a lot’

- b. *A o utlule [gore Mpho o rekile koloj]?  
 –Ee, ke utlule jalo / \*ke go utlule.  
 èè kī-útlú-l-è dʒalù / \*kī-χú-útlú-l-è  
 yes S1S-hear-PFT-FIN thus S1S-O3:15-hear-PFT-FIN  
 ‘Did you hear that Mpho bought a car? –Yes, I heard that / it’*

The data are summarized in the following table:

(27)

nominal Infinitives	verbal Infinitives
may include nominal deps	may not include nominal deps
the first argument is realized as a genitive or pragmatically interpreted	the first argument is controlled or raised
if object, cannot be separated from the V	can be separated from the V
trigger applicative form (with intr.)	does not obligatorily trigger applicative form (with intr.)
pronominalized like NP	not pronominalized like NP

### 3 Phrasal Analyses for Hybrid Expressions

The data raise two questions: how do we analyze the relation between ordinary verb forms such as indicatives and the verbal infinitive, and how do we analyze the relation between the verbal and the nominal infinitives?

There is a certain rationale in taking the infinitives in their two uses to be completely separate items: in their verbal use, they syntactically behave like a verb (see (27)). However, if we look at the morphological properties, we see that the infinitive, even in its verbal use, contains the prefix *go-*, which is a n-class prefix in the nominal use.

Starting with this observation, there are two possible ways to go. The first analysis chooses to ignore this striking common morphology. Consequently, it treats the infinitive in its verbal use as a verb (the infinitive is a verb form which happens to have a prefix homonym with a n-class prefix), and the relation between the two uses can be described with a Lexical Rule, given in (28).

(28) Lexical Rule : verbal infinitive => nominal infinitive

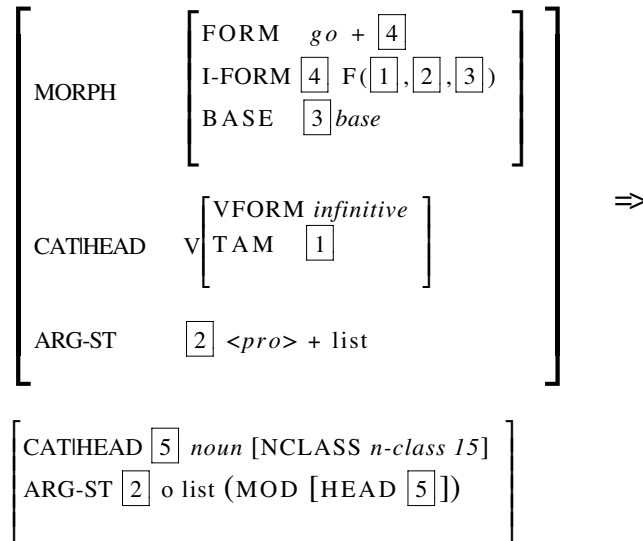

This is not satisfactory. First, it is very strange that the same prefix *go-* which has nothing nominal in the verb form, miraculously transforms itself into a n-class prefix in the output of the rule. Second, the noun itself is a very strange noun, in that it is inflected like a verb, and it combines with dependents which are found nowhere else in Tswana with nouns: object NP, PP complements and adverbs. Thus, although the solution is technically possible, it completely misses the common properties of the two uses (see sections 2.1 and 2.2).

The second type of analysis attempts to account for the common morphological and syntactic properties, using a phrasal representation which relies both on nominal and verbal categories. A simple category switch analysis would look as in (29) for the verbal infinitive (cf. (7), ‘to drink beer in the street’). In order to account for the nominal prefix, we add an edge feature (such as ‘[Nomin +]’, see e.g. Tseng 2003 on edge features), which is shared by the V, and realized as the prefix *go-*.

(29)

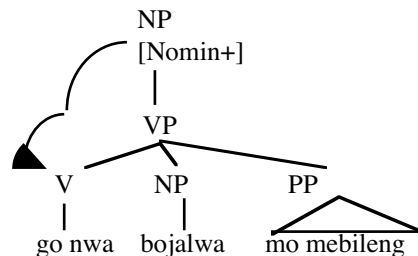

There are two problems. First, within the HPSG framework, this is not an ordinary phrase; it drastically violates the Head Feature Principle, so



that we have to set up a new construction devoted to that case. Second, this corresponds to the verbal use of the form; in spite of its containing both nominal and verbal categories, it does not help with representing the nominal use.

A more flexible version of the phrasal solution is offered in LFG by Bresnan (1997), and applied to Kikuyu by Mugane (2003). The infinitive would be an N taking a (verbless) VP complement, the N and the VP sharing their functional structure (in particular, the predicate and its arguments defined by their grammatical function).

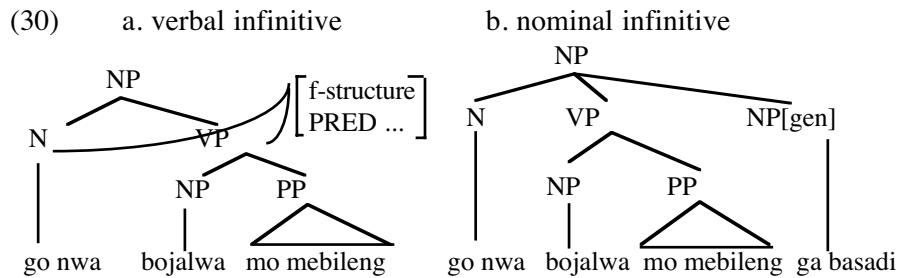

This analysis can account for the mixed morphology: the n-class prefix would follow from the category N, while the verbal inflexion would depend on the f-structure inherited from the VP. It can also account for the fact that infinitives can take both verbal and nominal dependents (see (30b)).

However, the definition of head sharing on which the analysis relies amounts to void the categorial distinction between N and V. It requires an extension of the extended head theory. The latter says that a ‘functional’ category (like Infl) can be an extended head if (i) it shares its functional structure with its lexical sister, and (ii) the two syntactic categories are ‘non distinct’ (like Infl and VP). In our case (see (30)), we have (a) to allow for functional structure sharing between a lexical head (the N) and its sister (the VP), and (b) to say that N and VP are ‘non distinct’. An appeal seems to be made to morphology to justify this extension (“the extended head [can be] a morphological derivative of a category identical / nondistinct from the phrase”, Bresnan 1997:14). But, of course, morphological derivation involving a verb and a noun is supposed to construct items belonging to different syntactic categories.

So, the representation in (30a) is better seen as a different configuration for head sharing, independent of the cases appealing to the notion of an ‘extended head’. In other words, (30a) is a phrasal representation of a nominalization, with a head N sharing its functional structure with a verbless VP sister. From an HPSG point of view, at least, this raises the question of how to license headless phrases: it is not clear how it can be done, given that it does not correspond to a deletion configuration. In fact, the problem is severe, when one considers infinitives without a complement as in (16). This implies a dangling VP, dominating nothing or dominating an empty category whose status is unclear.

The distinction between the two uses of infinitives is problematic for phrasal analyses of such hybrid constituents, precisely because they suppose that the constituent is always an NP. Certainly, it is a useful idea to say that the two uses differ semantically (as is done in Bresnan 1997, following an unpublished proposal by A. Spencer; we take up this proposal in section 4.2). However, the two uses also differ syntactically, as shown in sections 2.3 and 2.4. In particular, they are not found in the same environments (although there is a certain intersection). Verbal uses are found as arguments of subject control / raising verbs (23). It is an unusual property for nouns to allow for control or raising of their first argument; this characterizes nouns which form a complex predicate with the verb (as in ‘light verb constructions’). However, we have no indication that this is indeed the case. In addition, this analysis would mean that the two uses of infinitives correspond not only to different semantics, but also to different syntax, a loss of generalization if there is a way to preserve their syntactic unity.

Word order is also a source of a potential difficulty for phrasal analyses. As stressed by Mugane (2003) for Kikuyu, in the nominal use, we find that nominal and verbal dependents are interspersed (see section 2.1). The order for the phrase ‘for women to drink beer in the street’ (30b) usually contains the genitive between the object NP and the PP, see (12). A phrase structure such as (30b) does not immediately offer a way to get such an ordering. However, the problem disappears if we adopt domain union as proposed by Reape (1994), where the word order domain (the value of the feature DOM) can be bigger than the constituency domain. We can say that the VP which shares its functional structure with its N sister is not compacted (does not form a unit with respect to word order), a property noted by the feature [UN+]. Accordingly, the elements of the VP belong to the same word order domain as the genitive, at the NP level. In this proposal, (12) is analyzed as in (31).

(31)

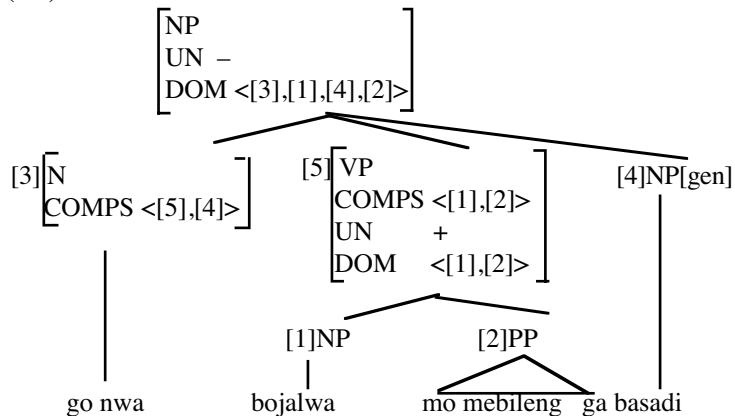

Let us summarize the difficulties that the phrasal analyses face with the Tswana infinitives. Either they treat the verbal use of the infinitive as a pure verb form, thus failing to account for the nominal aspect of its

morphology, which is viewed as a pure accident. Or, they account for it with a special construction using both nominal and verbal categories, but this construction goes against the usual categorial properties (either it violates the Head Feature Principle, or it downplays the usual distinction between verbs and nouns), and the solution still has to be supplemented with a way to represent the distinction between the two uses, and an appeal to domain union.

## 4 A Mixed Category Analysis

In this section, we show that the lexical solution proposed by Malouf (2000), which relies on setting up a mixed category, or part-of-speech which is neither N nor V, but inherits from more general verbal and nominal parts-of-speech, is superior to the phrasal analyses explored in the preceding section. It can account directly for the common properties of the two uses, without setting up a special phrase or blurring the distinction between N and V, and without appealing to domain union.

### 4.1 The common properties

First, we analyze the infinitive word itself. We propose that it has the same HEAD value in its verbal and nominal uses, which we call ‘infinitive’. The partial hierarchy of HEAD values that we need for Bantu languages is given in (32).

(32) A (partial) hierarchy of HEAD values for Bantu languages

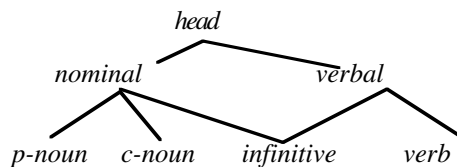

The value *infinitive* inherits both from *verbal* and from *nominal*. As argued above, we want to account for the common, mixed morphology of Tswana infinitives. We do that with the following constraints which are associated with the underspecified values *verbal* and *nominal*:

$$(33) \text{ a. } verbal \Rightarrow \left[ \text{HEAD|TAM} \left[ \begin{array}{l} tam \\ \text{VFORM } vform \\ (\text{TENSE } tense) \\ (\text{POL } pol) \end{array} \right] \right]$$

$$\text{b. } nominal \Rightarrow [\text{HEAD|NCLASS } noun-class]$$

It must be stressed that, contrary to some presentations of this set up (e.g. Bresnan 1997), there is nothing more ‘indeterminate’ in mixed categories (head values) than in the more standard ones. Nothing prevents a precise specification of the properties attached to each value in the domain, including the ones which inherit from two underspecified values. According to (33), a word with infinitive head value has tam specifications, which correlate with a certain morphology, and also a n-class specification, which is more precisely *15*, which correlates with prefix *go-*. Next, we account for the relation between the infinitive words and the verb. We distinguish between verb-lexemes, which are [HEAD *verbal*], and the words which are built on this lexeme, and can be either [HEAD *verb*] or [HEAD *infinitive*]. Since, in this analysis, infinitive is a head value, we propose that it constrains the VFORM value, which we call ‘infinitival’.

The relation between the syntactic properties of the verb and its morphology are specially complex in Tswana (see Creissels et al. 1997, Creissels 2005). We suppose that they result from two different functions, F1 and F2, as in (34).

$$(34) \text{ infinitive-word} \Rightarrow \left[ \begin{array}{l} \text{MORPH} \left[ \begin{array}{l} \text{FORM} \quad F_1(\boxed{1}, \boxed{5}) \\ \text{I-FORM} \quad \boxed{1} \quad F_2(\boxed{4}, \boxed{2}, \boxed{3}) \\ \text{BASE} \quad \boxed{2} \end{array} \right] \\ \text{CATIHEAD} \quad \textit{infinitive} \left[ \begin{array}{l} \text{TAM} \quad \boxed{4} \\ \text{NCLASS} \quad \boxed{5} \quad / \quad 5 \end{array} \right] \\ \text{ARG-ST} \quad \boxed{3} \quad \langle \textit{pro} \rangle + \textit{list} \end{array} \right]$$

The *tam* and the *vform* values are further specified as in (35):

$$(35) \text{ a. } \left[ \begin{array}{l} \textit{tam} \\ \text{VFORM} \quad \textit{vform} \\ \text{TENSE} \quad \textit{tense} \\ \text{POL} \quad \textit{pol} \end{array} \right]$$

b. *vform* = {*indicative, subjunctive, imperative, relative, circumstantial, sequential1, sequential2, infinitival*}

The complex functions that relate the properties of verbal words (verbs or infinitives) to their morphology result in a template that is organized around the root, and can be schematized as follows:

(36) Tswana verbal template

-4	-3	-2	-1	0	+1	+2	+3	+4
pol-1	subj-affix, n-class 15	tense, pol	obj-affix, refl.	root	caus, appl., recipr	perfect (pos)	passive	final vowel

Note that the base which appears in (34) is the combination of the root with the processes mentioned in (36), which modify the argument structure of the basic lexeme (causative, applicative, passive).

Finally, we note that the domain for head values in (32), as well as the distinction between lexemes and words, allows us to state an important cross linguistic tendency concerning nominalizations. It has been observed that words showing mixed verbal and nominal properties 'arise' from verbs, not from nouns. That is, we find verbs which are derived from nouns, but they are fully fledged verbs, they do not show mixed properties. Mixed properties characterize words which are associated with verbal lexemes. This generalization follows if, cross-linguistically, lexemes are or can be verbal (that is, underpecified, and giving rise to verb words and a mixed category like English gerunds and Tswana infinitives), while they cannot be nominal (nominal lexemes are already specified as common nouns, proper nouns etc.).

## 4.2 Verbal and nominal uses

The next question is how to account for the differences between the two uses of the Tswana infinitive, contrasted in sections 2.3 and 2.4. We propose that the two phrase types differ semantically, and we examine the constructions whose head is an infinitive word.

### 4.2.1 Denotation types

Essentially, we propose that the two uses of the infinitive differ semantically. Although the semantics of infinitive phrases in Tswana certainly requires a more in depth study, we present two arguments in favor of this hypothesis. First, when the infinitive phrase is a purpose clause, as in (22), it denotes an abstract object, presumably an 'outcome' in the typology of Ginzburg and Sag 2000, that is, a subtype of message. Thus, it is crucial to note that, in this case, the phrase cannot contain a nominal dependent such as a genitive. This indicates that a nominal use of the infinitive cannot be associated with an abstract object.

The second argument is as follows. There are some environments in which both nominal and verbal infinitives can occur. For instance, we have seen this with the psychological verb 'to be surprised' in (20) and (25), which are repeated below as (37a) and (37b).

- (37)a *O gākgamalela [go bua Setswana ga Lekgoa le].*  
 ú-χáq<sup>h</sup>ámál-èl-á χü-bú-á si-tswana  
 S3:1-be surprised-APPL-FIN INF-speak-FIN 7-Tswana  
 χá-lì-q<sup>h</sup>úà lé  
 15.GEN-5-European 5.DEM  
 ‘He is surprised by the fact that this European speaks Tswana’
- b. *O gākgamala [go utlwa Lekgoa le mmuisa ka Setswana].*  
 ú-χáq<sup>h</sup>ámál-à χü-utlw-á lì-q<sup>h</sup>úà  
 S3:1-be surprised-FIN INF-hear-FIN 5-European  
 lí-m-mú-ís-á ká sì-tswana  
 S3:5-O3:1-speak-CAUS-FIN PREP 7-Tswana  
 ‘He is surprised to hear the European speaking to him in Tswana’

Thus, we can ask what the intuition of the speakers is, when asked to compare a sentence such as (37a) with a nominal infinitive phrase, and a sentence such as (37b), with a verbal infinitive phrase. As these examples attempt to show, the interpretation associated with the two complement types is somewhat different, although it is difficult to pinpoint exactly where the difference lies. In (37b), the infinitive phrase seems to denote an eventuality, while in (37a), this eventuality is reified, hence the translation with ‘the fact that’. In addition, nominal infinitives, just like French or English derived nominals, can easily denote the manner in which an action is accomplished, as in (10), rather than the eventuality itself.

Now, eventualities are not abstract objects, but parts of the world. So, we cannot say that verbal infinitive phrases are always associated with abstract objects, although they can be. On the other hand, they are not associated with reified eventualities or manner of action, like nominal infinitive phrases. If we adopt the hypothesis sometimes defended (Asher 1993) that the object denoted by derived nominals is not exactly the same as the eventuality associated with the verb, we have the type ‘reified eventuality’, and we tentatively propose the following (partial) domain of semantic objects, where the abstract objects are as in Ginzburg and Sag 2000:

(38) A (partial) hierarchy of semantic objects

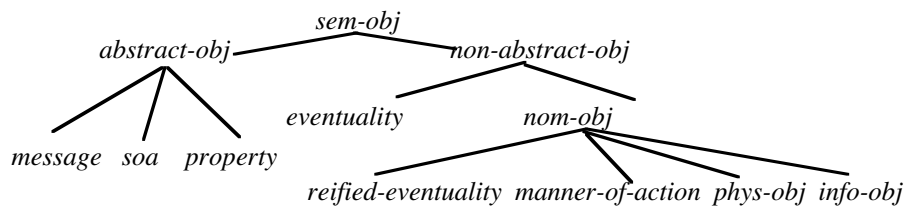

We propose that verbal infinitive phrases denote either an eventuality or an abstract object, while nominal infinitive phrases denote a nom-object. The latter will be either a reified eventuality or a manner-of-action,

because these are the nom-objects compatible with the relation associated with the verbal lexeme.

How do we go from the infinitive word denotation to the phrase denotation? We assume that infinitive words are underspecified in the lexicon: they denote a non-abstract-object, which can be further resolved into eventuality or nom-object. Let us assume that it is an eventuality: the phrase is verbal. At the level of the phrase, it can remain an eventuality (as in (37b)), or it can be raised to an abstract object, as in (22) (a type of message) or as in (23b) (if phrases whose subject is raised denote a property). If the denotation of the phrase were always raised to an abstract object, we could assume that it is a property of verbal infinitive constructions to turn the type from eventuality to abstract object. However, if we are right in assuming that the larger infinitive phrase in (37b) is an eventuality, this move is not adequate. Moreover, examining the same example (37b), we note that the larger Inf phrase includes an Inf phrase argument of a perception relation, and it is certainly usual to consider that the complement of perception verbs is an eventuality. In order to get the two denotations, we have two constructions, to which we come back in the following section. On the other hand, nominal infinitive phrases are associated with a nom-obj, like their head word.

#### 4.2.2 Infinitive constructions

We analyze all the dependents of the infinitive word as complements, whether they are subcategorized or not. The subcategorized ones are inherited by the infinitive word from the verbal lexeme: hence, they are shared by the infinitive and the verb words (such as the indicative forms). The others are modifiers which are turned into complements by the head-complements-construction. Regarding adverbs and locative PPs, we can assume either that they are modifiers which modify a verbal word (hence either a verb or an infinitive), or that they are optional complements of the verbal lexeme, and inherited as such by the infinitive. As for the nominal dependents, we analyze them all as nominal modifiers, that is, as elements which bear the specification [MOD *nominal*]. This is the case for the demonstrative, the adjective, the genitive (which, in this case, is co-indexed with the non-canonical *pro* subject of the head) and the relative clause.

Infinitive expressions can be words (as in (16)) or phrases. As for words, it remains to be seen whether it is better to treat them as lexical items directly entering the syntax, or as dominated by a head-only-construction. The question exceeds the scope of this paper, since the situation is frequent in Tswana. When they combine with complements, they are constrained by the head-complements-construction (39). As in e.g. Bouma et al. 2001, the modifiers are turned into complements.

(39) *head-complements-construction* =>

$$\left[ \begin{array}{l} \text{MOTHER} \quad [\text{CATIHEAD } \boxed{1}] \\ \text{HEAD-DTR} \quad [\text{ARG-ST } \langle \boxed{2} \rangle + \boxed{3}] \\ \text{NON-HD-DTRS} \quad \boxed{3} + \text{list}([\text{MOD } [\text{HEAD } \boxed{1}]]) \end{array} \right]$$

We can now semantically specify infinitive phrases, relying on three constructions.

(40) a. *infinitive-verbal-construction* =>

$$\left[ \begin{array}{l} \text{MOTHERICONTENT} \quad \boxed{1} \textit{eventuality} \\ \text{HEAD-DTR} \quad \left[ \begin{array}{l} \text{HEAD } \textit{infinitive} \\ \text{CONTENT } \boxed{1} \end{array} \right] \end{array} \right]$$

b. *infinitive-nominal-construction* =>

$$\left[ \begin{array}{l} \text{MOTHERICONTENT} \quad \boxed{1} \textit{nom-obj} \\ \text{HEAD-DTR} \quad \left[ \begin{array}{l} \text{HEAD } \textit{infinitive} \\ \text{CONTENT } \boxed{1} \end{array} \right] \end{array} \right]$$

c. *infinitive-propositional-construction* =>

$$\left[ \begin{array}{l} \text{MOTHERICONTENT} \quad \textit{abstract-object} \\ \text{HEAD-DTR} \quad \left[ \begin{array}{l} \text{HEAD } \textit{infinitive} \\ \text{CONTENT} \quad \textit{eventuality} \end{array} \right] \end{array} \right]$$

An expression allowed by one of the constraints in (40) is also allowed either as a word (possibly, a head-only-construction) or as a head-complements-construction. In (40a) and (40b), the content of the construction is identified with that of the infinitive head. Thus, the description in (34) is the underspecified description common to the two uses of the infinitive, which correspond to two lexical items, differentiated solely by their semantics. Alternatively, we could set up an analysis where the infinitive word itself would be a single lexical item, associated with a relation, semantic objects such as eventuality, abstract-object and nom-object being the content of the construct that enters into the syntax. We have chosen here a more conservative analysis, which moreover does not force us to set up head-only-constructions all over Tswana syntax. Note



that an infinitive denoting an eventuality can be the head either of an eventuality or a ‘propositional’ denoting construction.<sup>4</sup>

We must ensure that no nominal dependent appears in an infinitive-verbal-construct. In fact, this follows from their analysis as modifiers turned into complements. Their feature MOD specifies not only the part of speech of the expression they modify, but other properties such as content. Thus, we can say that demonstratives, genitives, adjectives and relative clauses specify that the expression they modify denote a nom-object.

Finally, let us look at word order. As indicated by the head-complements-construction, we assume that infinitive phrases have a flat structure: the head and all its complements are at the same level. It is thus completely expected that nominal dependents and dependents inherited from the verbal lexeme be interspersed, as long as linearization constraints are observed. The following are constraints on the order of the constituents in a head-complements-phrase. In addition to the initial position of the infinitive, we must ensure that the object NP (which we characterize as accusative, for simplicity) is not separated from the head, and that the nominal dependents are ordered among themselves. A relative clause comes last.

(41) Linearization constraints in the head-complements-construction

- a. Head **precedes** X
- b. NP[acc] **precedes** ¬[NP[acc]]
- c. demonstrative **precedes** NP[gen] **precedes** adjective
- d. X **precedes** [MOD *nominal*, HEAD *verb*]

An instance of a phrase which is allowed by (39), (40b) and (41) is given below.

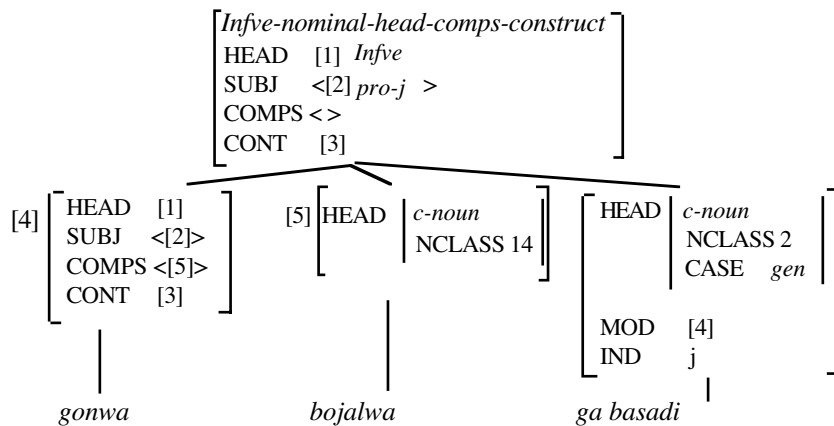

<sup>4</sup> We use ‘proposition’ as a cover term, not restricted to the denotation of a ‘proposition’, as a type of message (Ginzburg and Sag 2000). It remains to be seen how the denotation of the propositional infinitive construction is further restricted to some subtypes.

## 5 Conclusion

Phrasal and lexical analyses of hybrid nomino-verbal constructions are often believed to be equivalent. However, Tswana infinitives raise problems for phrasal analyses, and must be supplemented by an appeal to domain union. On the other hand, their common morpho-syntactic as well as word order properties follow straightforwardly from a domain of head values including a mixed category, while the differences between the nominal and the verbal uses are attributed solely to their semantics.

## References

- Asher, Nicolas. 1993. *Reference to Abstract Objects in English: a Philosophical Semantics for Natural Language Metaphysics*, Dordrecht: Kluwer.
- Bouma, Gosse; Robert Malouf and Ivan A. Sag. 2001. Satisfying constraints on extraction and adjunction, *Natural Language and Linguistic Theory* 19, 1-65.
- Bresnan, Joan. 1997. Mixed categories as head sharing constructions. In M. Butt and T.H. King (eds), *Proceedings of the LFG97 Conference*, Stanford: on line CSLI Publ.
- Cole, D. T. 1955. *An introduction to Tswana Grammar*. Cape Town: Longman.
- Creissels, Denis. 2003. Présentation du tswana. *Lalies* 23, 5-128.
- Creissels, Denis. 2005. Tswana verb morphology and the Lexical Integrity Principle, Fifth Mediterranean Morphology Meeting, Fréjus, (ms).
- Creissels, D., A.M. Chebanne and H.W. Nkhwa 1997. *Tonal Morphology of the Tswana Verb*. LINCOM Studies in African Linguistics.
- Du Plessis, J. A. 1982. Sentential Infinitives and Nominal Infinitives. *South African Journal of African Languages* 2/1.
- Du Plessis, J. A. and M. Visser 1992. *Xhosa Syntax*. Pretoria: Via Africa.
- Ginzburg, Jonathan and Ivan A. Sag. 2000. *Interrogative Investigations*. Stanford: CSLI Publ.
- Malouf, Robert P. 2000. *Mixed categories in the hierarchical lexicon*. Stanford: CSLI Publ.
- Mugane, John M. 2003. Hybrid constructions in Gikuyu: agentive nominalizations and infinitive-gerund constructions. In M. Butt and T. H. King (eds.), *Nominals: inside and out*, 235-265. Stanford: CSLI Publ.
- Pullum, Geoffrey. 1991. English nominal gerund phrases as noun phrases with verb-phrase heads. *Linguistics* 29, 763-799.
- Reape, Michael. 1994. Domain union and word order variation in German. In J. Nerbonne, K. Netter, and C. Pollard (eds), *German in Head-driven Phrase Structure Grammar*, 151-197. Stanford: CSLI Publ.
- Tseng, Jesse. 2003. Edge Features and French Liaison. J-B. Kim and S. Wechsler (eds), *Proceedings of the HPSG02 conference*, 313-333, Stanford: CSLI on line Publ.
- Visser, M. 1989. The Syntax of the Infinitive in Xhosa. *South African Journal of African Languages*. 9-4, 154-183.

# Syncretism in German: A unified approach to underspecification, indeterminacy, and likeness of case

Berthold Crysmann 

Universität des Saarlandes

Proceedings of the 12th International Conference on  
Head-Driven Phrase Structure Grammar

Department of Informatics, University of Lisbon

Stefan Müller (Editor)

2005

Stanford, CA: CSLI Publications

pages 91–107

Crysmann, Berthold. 2005. Syncretism in German: A unified approach to underspecification, indeterminacy, and likeness of case. In Stefan Müller (ed.), *Proceedings of the 12th International Conference on Head-Driven Phrase Structure Grammar, Department of Informatics, University of Lisbon*, 91–107. Stanford, CA: CSLI Publications. DOI: 10.21248/hpsg.2005.5. 

## Abstract

In this paper I address the phenomenon of syncretism in German and show how Flickinger (2000)'s approach to related issues in English can be adapted to provide a compact, disjunction-free representation of German nominal paradigms by means of combined case/number/gender type hierarchies. In particular, I will discuss the issue of case identity constraints in German coordinate structures, which has so far prevented successful application of Flickinger's proposal to German, and show how likeness constraints targetting individual inflectional dimensions of a combined type hierarchy can be expressed by means of typed lists that abstract out the relevant dimension.

I further show that current type-based approaches to feature neutrality are unable to combine the treatment of this phenomenon with the virtues of underspecification. I will then propose a revised organisation of the inflectional type hierarchies suggested by Daniels (2001), drawing on a systematic distinction between inherent and external (case) requirements.

## 1 Introduction

Nouns, adjectives and determiners in German inflect for case, number and gender. However, as is typical for inflectional languages, these morphosyntactic feature dimensions are not expressed by discrete, individually identifiable affixes. Rather, affixes realise complex feature combinations. Although four case, three gender and two number specifications can clearly be distinguished, the morphological paradigms of the language are characterised by heavy syncretism.<sup>1</sup>

	Singular	Plural
(1) Nom	der alte Computer	die alten Computer
Gen	des alten Computers	der alten Computer
Dat	dem alten Computer	den alten Computern
Acc	den alten Computer	die alten Computer

As illustrated by the paradigm in (1), German inflected nouns and adjectives are highly ambiguous at the word level. At the phrase level, however, ambiguity is somewhat reduced owing to the fact that, first, German NPs are subject to agreement in case, number, and gender, and second, determiners, adjectives and nouns are subject to different patterns of ambiguity.

---

<sup>†</sup>I would like to thank Stefan Müller and Michael Jellinghaus for fruitful discussion of several aspects of this work. I am also indebted to the audiences at the HPSG 2005 and FG-MoL 2005 conferences for comments on and discussion of the ideas presented here, in particular Carl Pollard and Shuichi Yatabe. A great many thanks also to the anonymous reviewers for their invaluable comments.

The work presented in this article was partially supported by research grants from the German Federal Ministry of Education, Science, Research and Technology (BMBF) to the DFKI project Quetal (FKZ 01 IW C02).

<sup>1</sup>See the Surrey Morphology Group syncretism database for a cross-linguistic overview (<http://www.surrey.ac.uk/LIS/SMG/>).

Often, syncretism cannot be resolved to disjunctive specification or underspecification within a single feature, but it cuts across the three inflectional dimensions: in our example above, the base noun *Computer*, can express either nominative, dative, and accusative singular, or nominative, genitive, and accusative plural. Likewise, the adjectival form *alten* can fill any cell in the (weak masculine) paradigm, except nominative singular. Although in principle, it is possible to provide a compact description of the set of readings in terms of nested disjunctions, one is actually forced to make an arbitrary decision as to which of the dimensions one wants to encode as the outer or inner disjunction (cf. (2) and (3))

$$(2) \left[ \begin{array}{cc} \text{CASE} & \textit{nom} \vee \textit{dat} \vee \textit{acc} \\ \text{NUM} & \textit{sg} \end{array} \right] \vee \left[ \begin{array}{cc} \text{CASE} & \textit{nom} \vee \textit{dat} \vee \textit{acc} \\ \text{NUM} & \textit{pl} \end{array} \right]$$

$$(3) \left[ \begin{array}{cc} \text{CASE} & \textit{nom} \vee \textit{acc} \end{array} \right] \vee \left[ \begin{array}{cc} \text{CASE} & \textit{dat} \\ \text{NUM} & \textit{pl} \end{array} \right] \vee \left[ \begin{array}{cc} \text{CASE} & \textit{gen} \\ \text{NUM} & \textit{sg} \end{array} \right]$$

A possible way to circumvent this problem is to revert to disjunctive normal form, as in (4): as a result, however, one will lose the generalisation that all six paradigm cells are actually expressed by one and the same form.

$$(4) \left[ \begin{array}{cc} \text{CASE} & \textit{nom} \\ \text{NUM} & \textit{sg} \end{array} \right] \vee \left[ \begin{array}{cc} \text{CASE} & \textit{dat} \\ \text{NUM} & \textit{sg} \end{array} \right] \vee \left[ \begin{array}{cc} \text{CASE} & \textit{acc} \\ \text{NUM} & \textit{sg} \end{array} \right] \vee \left[ \begin{array}{cc} \text{CASE} & \textit{nom} \\ \text{NUM} & \textit{pl} \end{array} \right] \vee \left[ \begin{array}{cc} \text{CASE} & \textit{gen} \\ \text{NUM} & \textit{pl} \end{array} \right] \vee \left[ \begin{array}{cc} \text{CASE} & \textit{acc} \\ \text{NUM} & \textit{pl} \end{array} \right]$$

This is even more unsatisfactory, if the linguistic expression under consideration is actually the unmarked citation form, as in the case of *Computer*.

Yet, typed feature formalisms, as argued in Flickinger (2000), offer an alternative to the use of disjunction, both within a dimension and across dimensions, namely type underspecification. Flickinger (2000) suggests to combine the inflectional dimensions of number and person in English to arrive at a compact representation of third singular and non-third singular agreement without the use of negation or disjunction. The key is to combine all the inflectional dimensions involved in syncretism into a single over-arching hierarchy.

Currently, one of the major obstacles for applying this strategy to the case of German is the kind of likeness constraints operative, e.g., in coordinating constructions, where agreement between conjuncts targets only a single inflectional dimension, namely case, to the exclusion of gender and number. I will show, in the first part of this paper, how list types can be fruitfully put to use to abstract out individual featural dimensions from combined case/number/gender type hierarchies, permitting the expression of likeness constraints, or type identity in coordinate structures.

Ambiguous nominal forms in German are also subject to indeterminacy or feature neutrality. Again, indeterminacy is not restricted to individual inflectional

dimensions, but rather follows the patterns of syncretism. Although the notions of ambiguity and indeterminacy are intimately related, there is currently no analysis at hand that is capable of combining the machinery necessary to cover feature indeterminacy with the benefits of underspecification.

In the second part of this paper, I will propose an entirely type-based approach to syncretism that will successfully reconcile Daniels (2001)'s approach to feature indeterminacy with morphosyntactic underspecification across features. As a result, the current proposal presents an entirely disjunction-free approach to syncretism, addressing indeterminacy, underspecification and likeness constraints.

## 2 Underspecification

In the context of grammar implementation, Flickinger (2000) compares disjunctive and type-based disjunction-free approaches to English verb agreement, in particular non-third singular agreement. Here, the problem is entirely parallel to German case/number/gender syncretism: like with German adjectives as *alten* in table (1), bare simple present forms in English can express every person/number specification except one: third singular. In order to provide a compact description of this unmarked form, one needs nested disjunctions as in (5), if person and number dimensions are to be represented by distinct features.

$$(5) \left[ \begin{array}{c} \textit{non-3rd-sg-verb} \\ \text{AGR} \left[ \begin{array}{cc} \text{NUM} & \textit{sg} \\ \text{PER} & 1 \vee 2 \end{array} \right] \vee \left[ \text{NUM} \quad \textit{pl} \right] \end{array} \right]$$

Flickinger then showed that by exploiting types it is possible to keep with a very concise representation of non-third singular verbs while at the same time eliminate all disjunctions: the key idea here is to give up the idea of having person and number dimensions of a paradigm represented as individual features, but instead represent these dimensions as part of a single type hierarchy (see (6)), the nodes of which corresponds to linguistically interesting groups of cells in an inflectional paradigm.

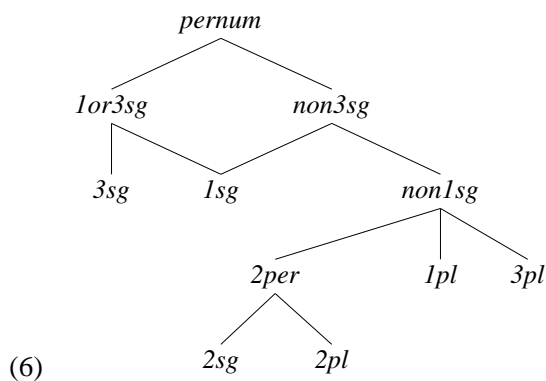

Combined with the fact that complementation within finite sets can always be captured by introducing appropriate supertypes into the hierarchy which subsume the relevant partition of (leaf) types ( $non3sg = pernum \wedge \neg 3sg$ ), the natural class of non-third singular verbs can be described most compactly, without any need for descriptive devices such as disjunction or negation.

$$(7) \left[ \begin{array}{l} non\text{-}3rd\text{-}sg\text{-}verb \\ AGR \left[ \begin{array}{l} PERNUM \\ non3sg \end{array} \right] \end{array} \right]$$

Most interestingly, the compactness of linguistic description achieved by the elimination of disjunctive features also pays off very well in terms of processing efficiency: comparing the performance of the disjunctive and the type-based approach, Flickinger (2000) shows that the latter outperforms the former by a factor of 3–4, with an otherwise unchanged grammar (the LinGO English Resource Grammar; ERG Copestake and Flickinger, 2000) running on the same processing platform (PAGE; Uszkoreit et al., 1994).

In the context of more strongly inflecting languages, such as German, where syncretism is the norm rather than the exception, underspecification of inflectional features across different dimensions is probably even more pressing: recall that a typical noun such as *Computer* can express any case/number combination, except genitive singular and dative plural, i.e. 6 in total. Using combined case/number/gender hierarchies, the syncretism between nominative/dative/accusative singular and nominative/genitive/accusative plural can be represented compactly as one entry. The very same holds for German determiners and adjectives: if only disjunctions within a single dimension are eliminated by means of type abstraction, we can still find a residual local ambiguity within each NP, of typically two readings per determiner, adjective, or noun. With disjunctive normal form, local ambiguity would be much higher indeed. Using a combined hierarchy of case/number/gender specifications, local ambiguity can be brought down to 1. Furthermore, such a move will avoid the motivational pitfalls of arbitrary decisions as to the relative nesting of disjunctions.

### 3 Likeness constraints in coordination

It has been argued by Müller (p.c.) that one of the main obstacles for exploiting combined case-number-gender hierarchies to provide an entirely disjunction-free representation of German syncretism surfaces in certain coordinate structures. It is a well-known fact about German that likeness of category in coordinate structures includes likeness of case specification, but excludes, as a rule, requirements concerning the likeness of gender or number specifications in the conjuncts, a pattern which is quite neatly predicted by HPSG’s segregation of HEAD features and INDEX features. However, in free word order languages like German, case arguably serves not only a categorial function, but also a semantic one, thereby supporting

the originally morphological motivation towards organising all agreement features into a single hierarchy (see also Kathol (1999) for a similar proposal). Moreover, the mere existence of indeterminacy across case and index features makes combined hierarchies almost inevitable.

Müller discusses syncretive pronominals in German, such as *der*, which is ambiguous, inter alia, between nominative singular masculine, as shown in (8), and dative singular feminine, as illustrated in (9).

(8) Der schläft.  
the.N.S.M sleeps  
'That one sleeps.'

(9) Ich helfe der.  
I help the.D.S.F  
'I help that one.'

This ambiguity could be represented by a type  $n-s-m+d-s-f$ .<sup>2</sup> Subcategorisation for nominative singular (type  $n-s-g$ ) or dative (type  $d-n-g$ ) will disambiguate these forms accordingly.<sup>3</sup>

In coordinate structures, however, we observe that likeness of case equally eliminates one of the possible gender specifications for *der*, as witnessed by the disambiguation (10). Thus, we must be able to distribute the case requirement over the two conjuncts in such a way that it can exert its disambiguatory potential, without actually unifying the entire case/number/gender specifications of the two conjuncts.

(10) Ich helfe der und dem Mann.  
I help the.D.S.F and the.D.S.M man  
'I help this one and the man.'

In Daniels (2001), this problem was partly anticipated: he suggests to address the issue of likeness of case by means of a relational constraint **same-case/2**, which restricts the two arguments to satisfy identical type requirements. This type equality is essentially imposed by disjunctive enumeration of the four possible subcategorised case values. In typed feature formalisms without relational constraints, his solution may be mimicked by means of unfolding the relevant phrase structure schemata into case-specified variants. In both cases, a greater part of the efficiency gains achieved by underspecification may get eaten up by this disjunctive approach to case similarity.

<sup>2</sup>As a convention, I am using the following nomenclature of combined c(ase)-n(umber)-g(ender) types: the three inflectional dimensions are specified in the above order, separated by a hyphen. In the first slot, *c* represents the most general case "value", *n, g, d, a* the most specific. "Disjunctive values" are represented as combinations of case specifications. The very same holds number and gender specifications.

<sup>3</sup>For ease of exposition, I am abstracting away from the internal/external distinction, which is immaterial here, since we are only dealing with underspecification, not indeterminacy.



An alternative, though not fully satisfactory solution would involve retaining a HEAD feature CASE along-side the combined AGR feature. While this move will be at least effective in ruling out unacceptable surface strings, it will fail to impose the disambiguation potential of the subcategorising head onto the individual conjuncts.

What is really needed here is a data structure that may serve to both express the appropriate case-requirements in terms of a combined hierarchy, and permit arbitrarily many specific instantiations of the case constraint. Fortunately, typed feature formalisms do provide for such a data structure, namely typed lists.

To start with, we will set up a hierarchy of case list types, as depicted in figure (11)<sup>4</sup>, where each list type immediately subsumes at least one subtype representing a non-empty list of the same case type.

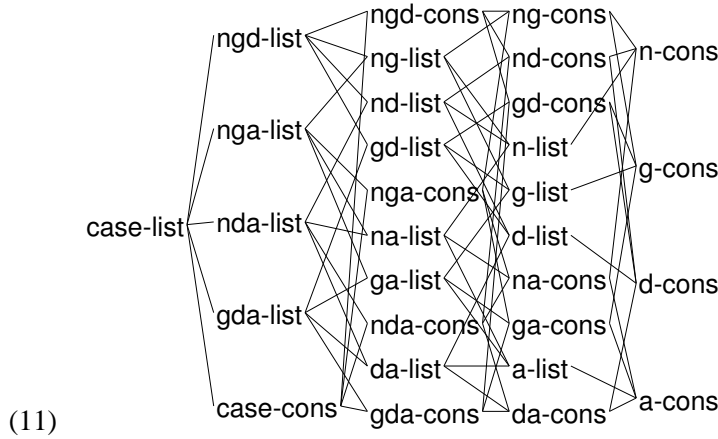

Types in the combined case-number-gender hierarchy will now restrict their CASE value to an appropriate list type, as given in (12).<sup>5</sup>

$$(12) \quad nda-n-g \rightarrow [CASE \quad nda-list]$$

Non-empty case lists bear a type constraint restricting the FIRST value to the corresponding agreement type in the combined case/number/gender hierarchy. Actually, thanks to type inference in the hierarchy of case lists, we only need to do this for the 4 immediate subtypes of *case-cons*, namely *ngd-cons*, *nga-cons*, *nda-cons*, and *gda-cons*. In order to propagate the case specification onto all elements of the open list, the tail is constrained to the corresponding list type (see (13)).

$$(13) \quad nda-cons \rightarrow \langle nda-n-g \mid nda-list \rangle$$

Now that we have a data structure that enables us to encode likeness of case for arbitrary instances of case/number/gender types, all we need to do is refine

<sup>4</sup>The type hierarchy has been exported from the LKB: supertypes are on the left, subtypes are on the right.

<sup>5</sup>Recall that, according to our naming convention, the type *nda-n-g* represents all case specification except genitive. Number and gender are fully underspecified.

our existing coordination schemata to distribute the case restriction imposed on the coordinate structure onto the individual conjuncts. In the implemented German grammar we are using, coordinate structures are licensed by binary phrase structure schemata. Thus, all we have to do is to constrain the AGR feature of the left conjunct daughter to be token-identical to the first element on the mother's AGR|CASE list, and percolate the rest of this list onto the (recursive) righthand conjunct daughter's AGR|CASE value:

$$(14) \quad coord-phr \rightarrow \left[ \begin{array}{l} SS | L | AGR | CASE \langle \boxed{1} | \boxed{2} \rangle \\ \text{COORD-DTRS} \left\langle \begin{array}{l} [SS | L | AGR \boxed{1}], \\ [SS | L | AGR | CASE \boxed{2}] \end{array} \right\rangle \end{array} \right]$$

Coordinating conjunctions, which combine with a conjunct by way of a head-complement rule, will equate their own AGR|CASE|FIRST value with the AGR value of their complement, percolating the case constraint onto the last conjunct.

$$(15) \quad \left[ \begin{array}{l} SS | L \left[ AGR | CASE \langle \boxed{1} | list \rangle \right] \\ VAL | COMPS \left\langle \left[ L | AGR \boxed{1} \right] \right\rangle \end{array} \right]$$

Besides coordination, the current approach to likeness constraints across syntretive forms can also be applied to case/gender agreement in German constructions involving the phrase *ein- nach d- anderen* 'one after the other', a set of phenomena discussed by Höhle (1983) and Müller (1999, 2001):

- (16) Wir<sub>i</sub> helfen ihnen<sub>j</sub> [einem nach dem anderen]<sub>\*i/j</sub>  
 we.NOM help them.dat one.DAT.M after the.M other  
 'We help them one after the other.'
- (17) Wir<sub>i</sub> helfen ihnen<sub>j</sub> [einer nach der anderen]<sub>\*i/j</sub>  
 we.NOM help them.dat one.DAT.F after the.F other  
 'We help them one after the other.'
- (18) Wir<sub>i</sub> helfen ihnen<sub>j</sub> [einer nach dem anderen]<sub>i/\*j</sub>  
 we.NOM help them.dat one.NOM.M after the.M other  
 'We help them one after the other.'
- (19) Wir<sub>i</sub> helfen ihnen<sub>j</sub> [eine nach der anderen]<sub>i/\*j</sub>  
 we.NOM help them.DAT one.NOM.F after the.F other  
 'We help them one after the other.'

As illustrated by the data in (16–19) above, agreement between antecedent and the phrase *ein- nach d- anderen* 'one after the other' proceeds along two inflectional dimensions: case and gender. Within the phrase *ein- nach d- ander-*, we find

gender agreement between the two pronominal *ein-* and the NP *d- anderen*. Case of the latter is invariantly dative, since it is governed by the preposition *nach*. The important aspect of this construction now is that the gender agreement between the pronominals partially disambiguates the case specification: e.g., the pronominal *einer* displays syncretism between nominative masculine and dative feminine (singular). As witnessed by the contrasts in (17) and (18), disambiguation of case syncretism by means of grammatical gender reduces the semantic attachment potential of the entire phrase, precluding attachment to the subject in (17), and to the object in (18).

The situation we encounter here is actually highly parallel to the one we found earlier with likeness of case in coordinate structures: again, agreement only targets a subset of the inflectional dimensions (case and gender) to the exclusion of others (person and number). What is therefore needed, is, again, a mechanism to abstract out the relevant dimensions from our syncretism types. While we can directly reuse our list-valued CASE feature to implement case agreement, we have to provide an analogous abstraction of the gender dimension, a step, which is very much straightforward:

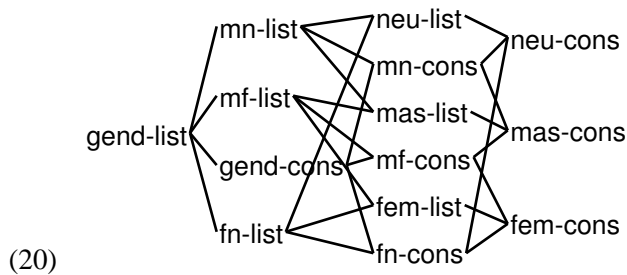

(21)  $c-n-mn \rightarrow [\text{GEND } mn\text{-list}]$

(22)  $mn\text{-cons} \rightarrow \langle c-n-mn \mid mn\text{-list} \rangle$

Again, we need a hierarchy of list types, and connect it — via type constraints — to appropriate types in the combined *c-n-g* hierarchy.

Having established the required abstraction of gender alongside case, we are now in a position to capture the interaction of case and gender agreement. All it needs, is to require that, in the phrase *ein- nach d- anderen*, the PP *nach d- anderen*, which exhibits gender agreement with the pronoun *ein-*, will equate the first element of its GEND list with the AGR value of *ein-*, either constructionally, or via a selection feature, e.g. MOD.

As a result, the entire AGR value of *ein-* will be disambiguated to a *c-n-g* specification compatible with the PP's gender. The AGR value of the entire construction, which represents an aggregate of singular entities, will be the unification of a constructional plural specification (*c-p-g*) with the first elements on both CASE and

GEND of *ein-*. This AGR value will then be unified with that of the antecedent.<sup>6</sup>

$$(23) \left[ \begin{array}{l} \text{SS} | \text{L} | \text{AGR } c-n-p \wedge \boxed{1} \wedge \boxed{2} \\ \left\langle \begin{array}{l} \text{PH} \langle \text{einer} \rangle \\ \text{SS} | \text{L} | \text{AGR } n-s-mn+d-s-f \wedge \boxed{3} \left[ \begin{array}{l} \text{CASE} | \text{FIRST} \boxed{1} \\ \text{GEND} | \text{FIRST} \boxed{2} \end{array} \right] \\ \text{PH} \langle \text{nach der anderen} \rangle \\ \text{SS} | \text{L} | \text{AGR } d-s-f \wedge \left[ \begin{array}{l} \text{CASE } d\text{-list} \\ \text{GEND} \left[ \begin{array}{l} fem\text{-cons} \\ \text{FIRST} \boxed{3}c\text{-n-f} \end{array} \right] \end{array} \right] \end{array} \right\rangle \end{array} \right]$$

To conclude, we have seen that the approach to likeness of case in coordinate structures can be extended, in a principled way, to other phenomena displaying partial agreement, i.e. agreement involving only a subset of inflectional dimensions. Furthermore, as illustrated by our analysis of the overlapping of gender and case agreement, the combination of dimensions in partial agreement can essentially be reduced to abstracting out each dimension individually and having them interact by means of unification.

Under a more general perspective, the technique employed here to abstract out certain dimensions from a more complex hierarchy by means of typed lists can be regarded as a sort of closed-world variant of type identity. As such, it certainly has an application potential which goes far beyond the concrete problems solved here.

#### 4 Feature neutrality

It has been argued by Ingria (1990) that the phenomenon of feature neutrality in coordination constitutes a severe challenge for unification-based approaches to feature resolution and concludes that unification should rather be supplanted by feature compatibility checks.

- (24) Er findet und hilft Frauen.  
 he finds.A and helps.D women.A/D  
 ‘He finds and helps women.’
- (25) \* Er findet und hilft Kindern.  
 he finds.A and helps.D children.D
- (26) \* Er findet und hilft Kinder.  
 he finds.A and helps.D children.A

<sup>6</sup>In order to make the lexical specification of case/number/gender information more transparent, I have left the unification of values in (23) unresolved.

Unification-based frameworks such as LFG or HPSG have taken up the challenge, refining the representation of feature constraints in such a way that neutrality can be modelled without any substantial changes to the underlying formalism. For HPSG, Daniels (2001) proposed to address these problems by means of enriching the type hierarchy to include neutral types, an idea originally due to Levine et al. (2001).<sup>7</sup>

Daniels (2001) has also discussed cases where the potential for feature indeterminacy does not only involve the values of a single feature: as illustrated in (27), a masculine noun like *Dozenten* can express any cell of the case/number paradigm except nominative singular. Accordingly, one and the same form can be subject to feature indeterminacy regarding number, gender, or even case.

- (27) der Antrag des           oder der           Dozenten  
the petition Def.G.Sg or   Def.G.Pl lecturer.G/D/A+N.Pl  
‘the petition of the lecturer(s)’
- (28) der                   oder die            Abgeordnete  
Def.N.M.Sg or   Def.N.F.Sg representative.N.Sg.M/F  
‘the male or female representative’
- (29) Er findet   und hilft   Dozenten.  
he finds.A and helps.D lecturers.A/D  
‘He finds and helps lecturers.’
- (30) a.   mit jedem            Mann oder Kind  
with every.D.Sg.M/N man.M or   child.N  
‘with every man or child’
- b.   \*jeder            Mann        oder Kind  
every.N.Sg.M man.N.Sg.M or   child.N.Sg.N  
‘with every man and child’
- c.   \*jedes            Mann        oder Kind  
every.N.Sg.N man.N.Sg.M or   child.N.Sg.N  
‘with every man and child’

A determiner like *der* is neutral between nominative singular masculine and genitive/dative plural. However, indeterminacy with respect to number is not independent of case, as illustrated by (31), where the unavailability of a nominative singular reading for *Dozenten* is responsible for the illformedness of the sentence.

- (31) \* der                                   Dozenten                    ist hier  
the.N.Sg.M+G/D.Sg.F+G.Pl lecturer.G/D/A+N.Pl is here

---

<sup>7</sup>Within LFG, a technically different, though conceptually similar approach has been developed by Dalrymple and Kaplan (2000). See Levy and Pollard (2001) for a comparison.

To incorporate the issue of neutrality across features, Daniels suggests to combine values of different inflectional features into an overarching type hierarchy, the nodes of which are essentially derived by building the Cartesian product of the types within each inflectional dimension.

#### 4.1 The Problem

Although both feature indeterminacy and ambiguity do call for type hierarchies combining different inflectional dimensions, these two approaches have not yet received a unified treatment to date: it has been recognised as early as Zaenen and Karttunen (1984) that in unification-based formalisms feature neutrality cannot be reduced to underspecification. The apparent incompatibility of neutrality and underspecification is even more surprising, as these two notions are intimately related: i.e., the ambiguity of a form between two values is a necessary prerequisite for this form to be embeddable in a neutral context.

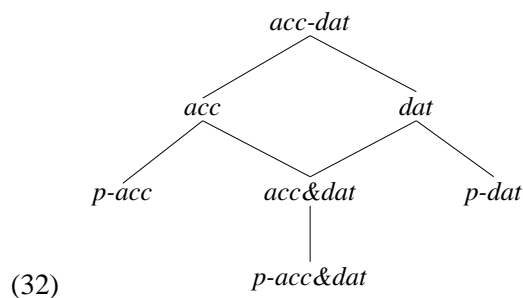

Taking as starting point the case hierarchy proposed by Daniels (2001), one might be tempted to assign a case-ambiguous form like ‘Frauen’ a supertype of both *acc* and *dat*, e.g. *acc-dat*, which can be resolved to *p-acc* (‘die Frauen’) or *p-dat* (‘den Frauen’), depending on context. However, to include feature-neutrality, it must also be possible to resolve it to the neutral type *acc&dat*. Suppose now that a form like *die* ‘the’ is itself ambiguous, i.e. between nominative and accusative, representable by a type *nom-acc*, again a supertype of *acc*. Unification of the case values of *die* ‘the’ and *Frauen* ‘women’ will yield *acc*, which will still be a supertype of the neutral type *acc&dat*, erroneously licensing the unambiguously non-dative *die Frauen* ‘the women’ in the neutral accusative/dative context of *findet und hilft* ‘finds and helps’.

- (33) \* Er findet und hilft [die Frauen]  
 he finds.A and helps.D [the women].A

Thus, under Daniels’s account, lexical items are explicitly assigned leaf type values, so-called “pure types”. While successful at resolving the issue of indeterminacy, this approach in fact drastically increases the amount of lexical ambiguity, having to postulate distinct entries for type-resolved pure accusative, pure dative, pure nominative, pure genitive, as well as all pair-wise case-neutral variants of a

single form like *Frauen* ‘women’. Ideally, all these different readings should be representable by a single lexical entry, if only underspecification could be made to work together with indeterminacy.

## 4.2 A Solution

The reason for the apparent incompatibility of underspecification and feature neutrality lies with the attempt to address both aspects within a single type hierarchy. Instead, I shall argue to draw a principled distinction between inherent inflectional feature values, where unification specialises from underspecified or ambiguous types to unambiguous types, and external or subcategorised feature values where unification proceeds from non-neutral, though generally unambiguous to neutral types. As a result we will have two partially independent hierarchies, one for ambiguity (*i-case*) and an inverse one for neutrality (*e-case*).<sup>8</sup>

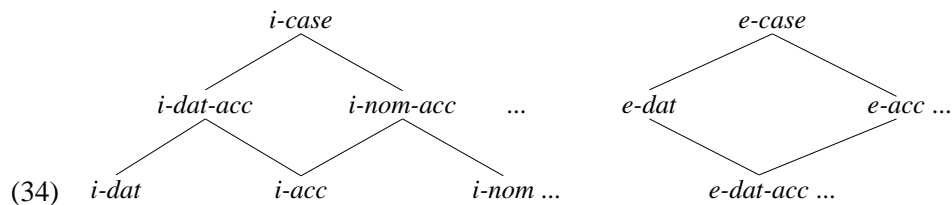

Inherent case specifications of dependents will be types in the *i-case* subhierarchy (for inherent case), whereas case requirements imposed by a subcategorising head will be values in the *e-case* subhierarchy (for external case). Unification of internal case specifications will result in disambiguation of underspecified case values, whereas unification of external case requirements will result in feature indeterminacy. To illustrate this, take the examples in (24) and (25): case ambiguous *Frauen* will be specified *i-dat-acc*, whereas unambiguous *Kindern* will carry the more specific value *i-dat*. Likewise, the verbs *finden* and *helfen* will subcategorise for an *e-acc* and *e-dat* complement, respectively. Coordination of the two lexical verbs will lead to unification of CAT values (Pollard and Sag, 1994),<sup>9</sup> and hence, valence lists, “overspecifying” the case requirement as *e-dat-acc*.

<sup>8</sup>In essence, the inverse layouts of the two subhierarchies correspond quite closely to the different behaviour of functor and argument categories with respect to strengthening/weakening in the approach of Bayer and Johnson (1995).

<sup>9</sup>For an overview of the treatment of coordination in HPSG, see Crysmann (in press).

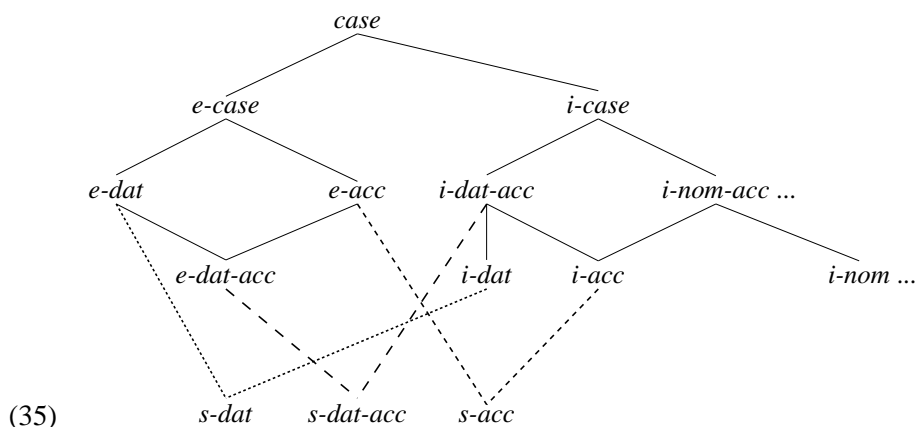

In order to permit satisfaction of any subcategorised case by some inherent case, all we need to do is define the greatest lower bound for any pair of internal and external case specification.

Thus, underspecified internal cases will unify with a corresponding neutral case, whereas specific internal cases will only unify with their corresponding non-neutral cases. As depicted above, more specific types in one hierarchy will be compatible with less specific types in the other, and vice versa. Returning to our example above, underspecified *i-dat-acc*, as in *Frauen* unifies with overspecified *e-dat-acc*, as required by the coordination *findet und hilft*, whereas unambiguous *Kindern* does not, since no greatest lower bound is defined for *i-dat* and *e-dat-acc*. Thus, disambiguation of *i-case* values will always reduce the potential for neutrality, as required. On a more conceptual level, these cross-classifications between the two hierarchies embody the logical link between underspecification and neutrality.

### 4.3 Discussion

The reader familiar<sup>10</sup> with recent work on non-constituent coordination within HPSG (Yatabe, 2003; Crysmann, 2003, to appear) may have noticed that these accounts already provide an alternative solution to the problem addressed by Daniels (2001): instead of coordinating two verbs with conflicting subcategorisation requirements, one might equally well assume coordination of VP or S, where identical peripheral material is simply suppressed:

- (36) Er findet (Frauen) und hilft Frauen.  
 he finds                    and helps women  
 ‘He finds and helps women.’

Although, purely theoretically, this is indeed a valid objection, once we look at available implementations of the HPSG formalism, we must conclude that sharing of domain objects is unsupported. As a consequence, in the light of implemented

<sup>10</sup>This issue has actually been brought to my attention by Carl Pollard.



HPSG grammars, Daniels (2001)'s approach to neutrality is still without competition.

On the other hand, the realisation of closed-world type identity by way of typed list constraints may equally well prove as an alternative approach to non-constituent coordination. One of the main concerns in current linearisation-based approaches to the phenomenon (Crysmann, to appear; Yatabe, 2003) is to ensure that instantiations of valence lists of a head within one conjunct do not, inadvertently, get identified with the valence lists of the shared, unexpressed head in the other conjunct. While Yatabe (2003) addresses the issue by explicitly composing pairs of valence list instantiations from both conjuncts, Crysmann (to appear) chooses to restrict sharing of domain objects to head information, basic phonology and the key semantic relation, thereby ensuring a sufficient degree of relatedness, without requiring identity of dependents, or even events.

Yet, once we subscribe to the idea that valence patterns within a language draw from a finite set, and that these patterns can be compactly represented as types, we have the necessary prerequisite in place for an account of head-sharing which is independent of domain object sharing, or even non-continuity: in essence, a phenomenon like conjunction reduction can then be modelled by creating a type-identical copy of the overt head, and saturate its valence lists with the non-head constituents of the second conjunct.

## 5 Conclusion

In this paper we have discussed how Flickinger (2000)'s type-based approach to the representation of inflectional feature specifications can be applied to syncretism in German. In particular, we have shown how likeness constraints abstracting out a particular inflectional dimension from a combined inflectional type hierarchy can be expressed concisely by means of typed lists, representing a closed-world analogue to type-identity. Furthermore, we have argued for an extension to Daniels (2001) original approach to feature indeterminacy in HPSG which makes it possible to combine the empirical virtues of his type-based approach to the phenomenon with the advantages of underspecified representation of syncretism across features, namely generality of specification and efficiency in processing.

## References

- Bayer, S. and Johnson, M. 1995. Features and Agreement. In *Proceedings of the 33rd Annual Meeting of the ACL*, pages 70–76.
- Copestake, Ann and Flickinger, Dan. 2000. An open-source grammar development environment and broad-coverage English grammar using HPSG. In *Proceedings of the Second conference on Language Resources and Evaluation (LREC-2000)*, Athens.

- Crysmann, Berthold. 2003. *Constraint-based Coanalysis. Portuguese Cliticisation and Morphology–Syntax Interaction in HPSG*. Saarbrücken Dissertations in Computational Linguistics and Language Technology, No. 15, Saarbrücken: Computational Linguistics, Saarland University and DFKI LT Lab.
- Crysmann, Berthold. in press. Coordination. In Keith Brown (ed.), *Encyclopedia of Language and Linguistics*, Oxford: Elsevier, second edition.
- Crysmann, Berthold. to appear. An Asymmetric Theory of Peripheral Sharing in HPSG: Conjunction Reduction and Coordination of Unlikes. In G. Jaeger, P. Monachesi, G. Penn and S. Wintner (eds.), *Proceedings of FGVienna: The 8th Conference on Formal Grammar, Aug 16–17 2003, Vienna*, Stanford: CSLI Publications.
- Dalrymple, Mary and Kaplan, Ron. 2000. Feature Indeterminacy and Feature Resolution. *Language* 76(4), 759–798.
- Daniels, Michael. 2001. On a Type-Based Analysis of Feature Neutrality and the Coordination of Unlikes. In *Proceedings of the 8th International Conference on Head-Driven Phrase Structure Grammar*, CSLI Online Proceedings, pages 137–147, Stanford: CSLI Publications.
- Flickinger, Daniel P. 2000. On Building a More Efficient Grammar by Exploiting Types. *Natural Language Engineering* 6(1), 15–28.
- Höhle, Tilman. 1983. Topologische Felder, ms., University of Cologne.
- Ingria, R. J. P. 1990. The limits of Unification. In *Proceedings of the 28th Annual Meeting of the ACL*, pages 194–204.
- Kathol, Andreas. 1999. Agreement and the Syntax-Morphology Interface in HPSG. In Robert Levine and Georgia Green (eds.), *Studies in Contemporary Phrase Structure Grammar*, pages 209–260, Cambridge and New York: Cambridge University Press.
- Levine, Robert, Hukari, Thomas and Calcagno, Michael. 2001. Parasitic Gaps in English: Some Overlooked Cases and their Theoretical Implications. In Peter Culicover and Paul Postal (eds.), *Parasitic Gaps*, pages 181–222, Cambridge, MA: MIT Press.
- Levy, Roger and Pollard, Carl. 2001. Coordination and Neutralization in HPSG. In *Proceedings of the 8th International Conference on Head-Driven Phrase Structure Grammar*, CSLI Online Proceedings, pages 221–234, Stanford: CSLI Publications.
- Müller, Stefan. 1999. An HPSG-Analysis for Free Relative Clauses in German. *Grammars* 2(1), 53–105.

- Müller, Stefan. 2001. Case in German – Towards an HPSG Analysis. In Walt Detmar Meurers and Tibor Kiss (eds.), *Constraint-Based Approaches to Germanic Syntax*, Studies in Constraint-Based Lexicalism, No. 7, pages 217–255, Stanford: CSLI Publications.
- Pollard, Carl and Sag, Ivan. 1994. *Head-Driven Phrase Structure Grammar*. Stanford: CSLI and University of Chicago Press.
- Uszkoreit, Hans, Backofen, Rolf, Busemann, Stephan, Diagne, Abdel Kader, Hinkelman, Elizabeth, Kasper, Walter, Kiefer, Bernd, Krieger, Hans-Ulrich, Netter, Klaus, Neumann, Günter, Oepen, Stephan and Spackman, Stephen P. 1994. DISCO - An HPSG-Based NLP System and its Application for Appointment Scheduling. In *Proceedings of the 15th International Conference on Computational Linguistics (COLING'94), August 5-9*, volume 1, pages 436–440, Kyoto, Japan.
- Yatabe, Shûichi. 2003. A Linearization-based Theory of Summative Agreement in Peripheral-Node Raising Constructions. In Jong-Bok Kim and Stephen Wechsler (eds.), *Proceedings of the 9th International Conference on Head-driven Phrase Structure Grammar, Kyung Hee University, Seoul, 5–7 August, 2002*, pages 391–411, Stanford: CSLI Publications.
- Zaenen, Annie and Karttunen, Lauri. 1984. Morphological Non-Distinctiveness and Coordination. In *Proceedings of the First Eastern States Conference on Linguistics (ESCOL)*, pages 309–320.

# A coordination module for a crosslinguistic grammar resource

Scott Drellishak

University of Washington

Emily M. Bender 

University of Washington

Proceedings of the 12th International Conference on  
Head-Driven Phrase Structure Grammar

Department of Informatics, University of Lisbon

Stefan Müller (Editor)

2005

Stanford, CA: CSLI Publications

pages 108–128

Drellishak, Scott & Emily M. Bender. 2005. A coordination module for a crosslinguistic grammar resource. In Stefan Müller (ed.), *Proceedings of the 12th International Conference on Head-Driven Phrase Structure Grammar, Department of Informatics, University of Lisbon*, 108–128. Stanford, CA: CSLI Publications. DOI: 10.21248/hpsg.2005.6. 

## Abstract

The Grammar Matrix is a resource for linguists writing grammars of natural languages; however, up to this point it has not included support for coordination. In this paper, we survey the typological range of coordination phenomena in the world's languages, then detail the support, both syntactic and semantic, for those phenomena in the Grammar Matrix. Furthermore, we describe the concept of a Matrix "module" and our software that enables grammar writers to easily produce an extensible starter grammar.

## 1 Introduction

The Grammar Matrix (Bender et al., 2002) is an attempt to distill the wisdom of existing broad-coverage grammars and document it in a form that can be used as the basis for new grammars. The main goals of the project are: (i) to develop in detail semantic representations and in particular the syntax-semantics interface, consistent with other work in HPSG; (ii) to represent generalizations across linguistic objects and across languages; and (iii) to allow for very quick start-up as the Matrix is applied to new languages. The current Grammar Matrix release includes types defining the basic feature geometry and technical devices (e.g., for list manipulation), types associated with Minimal Recursion Semantics (see, e.g., (Copestake et al., 2003)), types for lexical and syntactic rules, a hierarchy of lexical types for creating language-specific lexical entries, and links to the LKB grammar development environment (Copestake, 2002). It is, however, completely silent on the topic of coordination.

The next step in Matrix development is the creation of 'modules' to represent analyses of grammatical phenomena which differ from language to language, but nonetheless show recurring patterns (Bender and Flickinger, 2005). These modules are presented to grammar writers through a Web interface that allows them to specify grammatical properties of a language and then download a customized, Matrix-based 'starter-grammar' for that language. In this paper, we propose a design for a module pertaining to coordination. Coordination is an especially important area to cover early on as coordinated phrases have a relatively high text frequency and thus could pose an important impediment to coverage in the development of Matrix-based grammars. In addition, while the world's languages evince a wide variety of coordination strategies, many of the challenges of providing grammatical analyses of coordination constructions are constant across all of the different strategies. Thus a relatively compact statement of the full set of possible modules is possible and the insights gained in existing work on coordination in the English Resource Grammar (version of 10/04, <http://delph-in.net/erg>; (Flickinger, 2000)) can be reasonably directly applied to other languages.

---

<sup>†</sup>We would like to thank Dan Flickinger, whose analysis of coordination in the English Resource Grammar has served as the basis of this work, as well as the reviewers for and audience at HPSG 2005 for helpful discussion. In addition, we would like to thank the students in Linguistics 567, Spring 2005, for testing the coordination module in their grammars.

In this paper, we restrict our attention to *and* coordination but consider how coordination works for different phrase types as well as both 2-way and n-way coordination.<sup>1</sup> §2 provides a typological sketch of coordination strategies found in the world’s languages. §3 motivates design decisions we have taken in this analysis. §4 describes in detail our implementation of coordination. §5 presents a sample analysis of a coordination strategy in Ono, a Trans-New Guinea language. Finally, in §7 we discuss further extensions to the grammatical analysis and issues of the user interface.

## 2 Typology of Coordination

The term “coordination” (or sometimes “conjunction”) covers a wide range of phenomena across the world’s languages. In this initial version of the coordination module, we focus on syntactic structures in which two or more elements of the same (or similar) grammatical category are combined into a single larger element of the same category.

Even if we focus on this simplified subset of coordination, we find a wide variety of coordination strategies across the world’s languages and across the phrase types within those languages. These strategies can be classified along several dimensions; among these are the kind of marking, the pattern of marking, the position of the mark, and the phrase types coordinated by the strategy. The coordination module in the Matrix must accommodate all meaningful combinations of these dimensions. This is accomplished by the software underlying the Web interface, which customizes a starter grammar according to the answers provided by the grammar writer.<sup>2</sup>

### 2.1 Kinds of Marking

The kind of marking most familiar to speakers of Indo-European languages is lexical marking, in which one or more lexical items (also known as *conjunctions*) mark the connection between the coordinands. The English *and* is an example of a lexically-marked coordination strategy:

(1) Lions *and* tigers *and* bears

---

<sup>1</sup>We leave for future work issues such as non-constituent coordination or the interaction of syntactic and coordination (e.g., Beavers and Sag (2004); Dalrymple and Kaplan (2000)).

<sup>2</sup>It is worth noting that there exists in many languages an additional type of coordination strategy that is not covered by the Matrix coordination module. Following Stassen (2000), the world’s languages can be classified as either AND- or WITH-languages. AND-languages are those with the familiar syntactic coordination discussed here. WITH-languages, on the other hand, mark coordination asymmetrically: one coordinand is unmarked, while the others are marked by a particle or morpheme meaning “with”. In this type of coordination strategy, sometimes referred to as *comitative coordination*, the syntax (and possibly the semantics) is that of an adjunct. This strategy is quite common among the world’s languages, but we take it to be a separate phenomenon, and it is not covered by the Matrix coordination module.

In some languages, coordination is unmarked, being accomplished by the simple juxtaposition of the coordinands with no additional material, as in Abelam, a Sepik-Ramu language spoken in New Guinea:

- (2) wʌny balə wʌny aɕʌ wʌryʌ.bəŋ  
 that dog that pig fight  
 ‘that dog and that pig fight’ (Laylock, 1965, 56)

Note that the noun phrases glossed as “that dog” and “that pig” are simply juxtaposed, but they receive a coordinated reading.

In still other strategies, coordination is marked morphologically, usually by an affix on one of the words in a coordinand, as in this example from Kanuri, a Nilo-Saharan language:

- (3) kə̀rə̀zə̀ málə̀mrò wálwònò.  
 studied.CONJ malam became  
 ‘He studied and became a malam.’ (Hutchison, 1981, 322)

In this example, the two verb phrases are coordinated by marking the earlier verb with the “conjunctive form”.

Consider also this example from Telugu, a Dravidian language:

- (4) kamalaa wimalaa poDugu.  
 Kamala Vimala tall  
 ‘Kamala and Vimala are tall.’ (Krishnamurti and Gwynn, 1985, 325)

The two names being coordinated are marked simply by the lengthening of their final vowels. This kind of marking could possibly be analyzed as phonological rather than morphological. Languages with juxtaposition strategies may also be utilizing phonological marking, because such strategies are often marked by a distinctive “comma intonation” on each coordinand. For the purposes of this Matrix module, however, this kind of marking does not need separate treatment: strategies like the Telugu one above can simply be treated like other spelling-changing morphological rules, and intonation does not generally appear in orthographies (although punctuation may serve as a proxy for intonation).

## 2.2 Patterns of Marking

There are several different patterns of marking attested in the world’s languages. In *monosyndeton* strategies, one mark serves to coordinate any number of coordinands:

- (5) A B *conj* C  
 ‘A, B, and C’

In *asyndeton* strategies, no coordinands are marked. This is equivalent to juxtaposition:

- (6) A B C  
'A, B, and C'

In *polysyndeton* strategies, more than one coordinand is marked. For the purposes of the coordination module, it turned out to be important to distinguish between the case where all but one coordinand is marked, and where all coordinands are marked. We therefore reserve the term *polysyndeton* for the former ( $n - 1$  marks for  $n$  coordinands, (7)) and refer to the latter (8) as *omnisyndeton*.

- (7) A conj B conj C  
'A, B, and C'

- (8) conj A conj B conj C  
'A, B, and C'

For each pattern of marking above (except for *asyndeton*), there are two possible positions of the mark if it is a lexical item or prefix or suffix: before the coordinand, or after the coordinand. The English *and* (along with its cognates in most other Indo-European languages) is an example of a mark that comes before the coordinand, because it precedes the final one. The Latin suffix *-que*, on the other hand, is an example of a mark that follows the final coordinand:

- (9) Senatus Populusque Romanus  
Senate people.AND Roman  
'The Senate and people of Rome.'

### 2.3 Different Phrase Types

Finally, coordination strategies vary as to the types of phrases they cover. In the Indo-European languages, a single coordination strategy often serves to coordinate all types of constituent phrases. It is quite common, however, for coordination strategies to only cover a subset of the types of phrases in the language. For example, in Fijian the coordination of noun phrases is marked by the conjunction *kei*, while that of sentences, verb phrases, adjectival phrases, and prepositional phrases is marked by the conjunction *ka* (Payne, 1985, 5).<sup>3</sup>

### 2.4 Typology and the Web Interface

To summarize, then, we analyze coordination strategies in the world's languages as varying along four dimensions:

---

<sup>3</sup>See Drellishak (2004) for a survey of variation with respect to phrase types covered in coordination strategies in the world's languages.



1. Kind of Marking: lexical, morphological, none.
2. Pattern of Marking: a-, mono-, poly-, or omnisyndeton.
3. Position of Marking: before or after the coordinand.
4. Phrase types covered: NP, NOM, VP, AP, etc.

This analysis of the typological facts drove the design of the Web interface. The grammar-writer is presented with a brief explanation of the kinds of strategies that are covered, and then, for each coordination strategy, answers a series of questions by filling in form fields:

1. What phrase types are covered by the strategy?
2. Which of the marking patterns does it use?
3. Is it marked by a word or an affix?
4. What is the orthography of that word or affix?
5. Does the mark come before or after the coordinand?

When the form is submitted, software running on the web server checks to ensure that the answers are consistent (e.g. if a lexical strategy is specified, the orthography must be supplied), and then produces a starter grammar ready to be downloaded and used. It is worth noting that the set of grammars describable by answering these questions is somewhat smaller than the set of grammars the coordination module can support. For instance, coordination could be marked by an infix, reduplication, or other complex morphological process, or the marking pattern could vary somewhat from the patterns described above. §5 will describe how a coordination strategy with such a variant marking pattern can nonetheless be implemented on the basis of our analysis.

### 3 Design Decisions

#### 3.1 Category-specific Rules

It may seem desirable at first to have a single rule that covers the coordination of all phrase types. However, experience with detailed work on English (as represented by the English Resource Grammar) suggests that this is not practical, given our formalism and current assumptions about feature geometry. The core generalization<sup>4</sup> is that phrases of the same category can be coordinated to make a larger phrase of that category. Thus a common first-pass attempt at modeling coordination involves a rule that identifies HEAD and VAL values across the coordinands and the mother (see e.g., Sag et al. (2003)). However, there are features which have been placed inside HEAD for independent reasons which need not be identified across coordinands, such as AUX:

---

<sup>4</sup>This generalization is subject to several well known exceptions, which tend to have low text frequency.

(10) Kim slept and will keep on sleeping.

Further, there are differences in the semantic effects of coordination for individuals and events. In particular, we follow the ERG in introducing a new index for the coordinated phrase. Since all nominal indices must be bound by quantifiers in well-formed representations (Copestake et al., 2003), NP coordination rules must introduce a quantifier as well. Similarly, the NOM coordination rules must introduce quantifiers for each coordinand.

Finally, there are idiosyncrasies to coordination in certain phrase types. A prime example here is the agreement features on coordinated NPs in English. For NPs coordinated with *and*, at least, the number of the conjoined phrase is always plural, and the person is the lesser of the person values of other coordinands (first person and second person give first person, etc.). In the context of our cross-linguistic analysis, we also find languages where the coordination strategy is different for different phrase types.

In light of these facts, the analysis is considerably simplified by positing separate rules for the coordination of different phrase types. These rules stipulate matching HEAD values, rather than identifying them. The rules are, of course, arranged into a hierarchy in which supertypes capture generalizations across all of the different coordination constructions.

### 3.2 Binary branching structure

Whether coordination involves binary branching or flat structure is a matter of much theoretical debate (see e.g., Abeillé (2003)). Rather than review those arguments here, we present two engineering considerations which support a binary branching analysis.

First, while the LKB allows rules with any given number of daughters, it does not permit rules with an underspecified number of daughters. This means that a rule like (11a) would have to be approximated via some number of rules with a specific arity (11b):

- (11) a.  $XP \rightarrow XP+ conj XP$   
b.  $XP \rightarrow XP conj XP$   
     $XP \rightarrow XP XP conj XP$   
     $XP \rightarrow XP XP XP conj XP$   
    ...

The relevant rule from such a set would assign the following flat structure to three coordinated phrases:

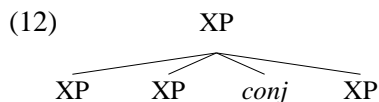

With binary branching, in contrast, three rules produce an unlimited number of coordinands:

- (13) XP → XP XP-co (top coord rule)  
 XP-co → XP XP-co (mid coord rule)  
 XP-co → *conj* XP (bottom coord rule)

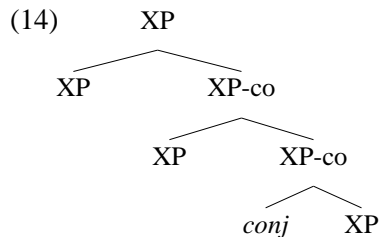

Second, there is the issue of “promotion” of agreement features in coordinated NPs (and potentially other phrase types). In French, for example, the gender value of a coordinated NP is masculine iff at least one of the coordinands is. In order to state this constraint in our system, we will need separate rule subtypes, one of which posits [GEND *masc*] on the mother and on one daughter, leaving the other daughter unspecified, and another that requires [GEND *fem*] on the mother and both daughters.<sup>5</sup> In either system, this means increasing the number of rules, but the binary branching system starts out with fewer rules (and in fact, only the top and mid coordination rules need to be duplicated, not the bottom coordination rule). The flat structure system, on the other hand, potentially has a very large number of rules to start with. When we also consider promotion of person values, the number of rules involved gets even larger, and the gain from the binary branching system becomes even clearer.

## 4 Implementation

The implementation of coordination in the Matrix is substantially based on the coordination implementation of the English Resource Grammar (ERG) (Flickinger, 2000). In particular, the Matrix uses a similar set of unary and binary rules and semantic relations to model the structure of *n*-way coordination. The Matrix coordination rules are simplified with respect to the ERG rules, because the Matrix does not support all the details of English coordination, as well as generalized, because the Matrix needs to cover coordination strategies quite unlike those of English.

### 4.1 Coordination Structures

The analysis introduced above will assign the following structure to three XPs coordinated with an English-like lexical strategy:

---

<sup>5</sup>(2000) set-based system for succinctly handling such facts is not currently available in the LKB.

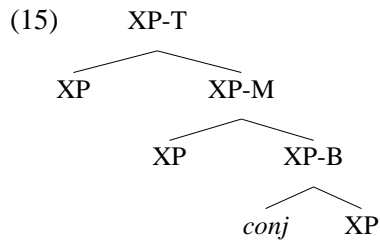

This is accomplished using three rules: a binary “top” rule, a binary “mid” rule, and a “bottom” rule. Other kinds of coordination strategies will be assigned similar structures, with the variation between strategies captured by variations in the mid and bottom rules: asyndeton and polysyndeton strategies lack a mid rule entirely, bottom rules can be either unary or binary depending on whether the strategy is marked lexically or morphologically, and omnisyndeton strategies require special treatment (see §4.1.3 below). Each coordination structure will consist of a single top phrase dominating the whole structure, one or more right-branching mid phrases, and a single bottom phrase dominating the rightmost coordinand (and its lexical or morphological marking, if any). Note that mid rules will iterate to deal with more coordinands, producing a single large coordination structure; for example, the coordination of four elements by an English-like lexical strategy will be assigned the following phrase structure:

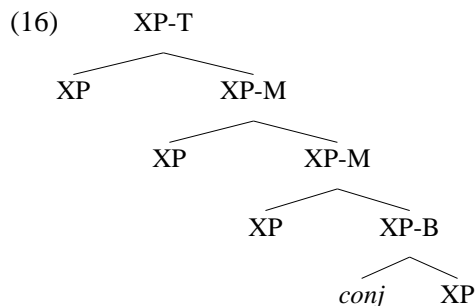

The top phrase is a full-fledged XP and can occur anywhere in a sentence a non-coordinated XP can occur, but the mid and bottom phrases should not combine with other constituents via the ordinary rules. Similarly, other kinds of phrases should not appear inside of a coordination structure. To enforce this, we define a new boolean feature *COORD* on *local-min* (the value of *LOCAL*). Constraints on types high in the hierarchy ensure that all lexical items and ordinary phrase structure and lexical rules are [*COORD* –]. The various patterns of marking can be defined by the *COORD* values of phrases and their left and right daughters (as discussed below).

Below are the portions of the feature structures that define the syntax of the Matrix’s basic coordination structures:

$$(17) \left[ \begin{array}{l} \textit{coord-phrase} \\ \text{SYNSEM} \mid \text{LOCAL} \mid \text{CAT} \left[ \begin{array}{l} \text{HEAD} \left[ \text{MOD} \boxed{1} \right] \\ \text{VAL} \quad \boxed{2} \end{array} \right] \\ \text{LCOORD-DTR} \boxed{3} \left[ \begin{array}{l} \textit{sign} \\ \text{SYNSEM} \mid \text{LOCAL} \mid \text{CAT} \left[ \begin{array}{l} \text{HEAD} \left[ \text{MOD} \boxed{1} \right] \\ \text{VAL} \quad \boxed{2} \end{array} \right] \end{array} \right] \\ \text{RCOORD-DTR} \boxed{4} \left[ \begin{array}{l} \textit{sign} \\ \text{SYNSEM} \mid \text{LOCAL} \mid \text{CAT} \left[ \begin{array}{l} \text{HEAD} \left[ \text{MOD} \boxed{1} \right] \\ \text{VAL} \quad \boxed{2} \end{array} \right] \end{array} \right] \\ \text{ARGS} \left\langle \boxed{3}, \boxed{4} \right\rangle \end{array} \right]$$

$$(18) \left[ \begin{array}{l} \textit{top-coord-rule} \\ \text{SYNSEM} \mid \text{LOCAL} \mid \text{COORD} \quad - \end{array} \right]$$

$$(19) \left[ \begin{array}{l} \textit{mid-coord-rule} \\ \text{SYNSEM} \mid \text{LOCAL} \mid \text{COORD} \quad + \end{array} \right]$$

The inheritance relationships for these types are shown in the following tree:

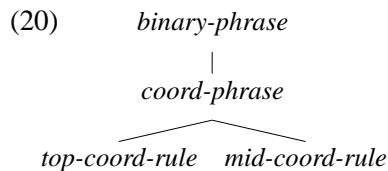

Note that all of these rules derive from *binary-phrase* (rather than *binary-headed-phrase*) and are therefore headless. This approach was chosen in order to avoid making an unwarranted typological generalization about the headedness of coordination structures.<sup>6</sup> It also prevents some obvious problems with agreement. Consider a language in which the coordination of two singular NPs triggers plural agreement. If AGR is a HEAD feature, then the HEAD value of the whole phrase cannot be identified with either coordinand. Note also that our approach does not identify the HEAD values of the two coordinands, for similar reasons. Consider again the number of coordinated NPs: it is perfectly grammatical to coordinate singular and plural noun phrases, even though the two have conflicting AGR values. Furthermore, although the Matrix Web interface only outputs strategies that cover single phrase types, this is not necessary in principle, because many languages allow coordination of non-identical categories. For all of these reasons, it would be

<sup>6</sup>See Borsley (2005) for a discussion of the problems with headed analyses.

inappropriate to identify any of the HEAD values involved in coordination structures. Instead, the phrase-specific rules derived from the above abstract rules must stipulate the HEAD types.

The remainder of section 4.1 discusses how we capture the variation in marking strategies (monosyndeton, polysyndeton, asyndeton, and omnisyndeton).

#### 4.1.1 Monosyndeton

For monosyndeton strategies, coordination structures are defined by the following rules (in which the value of COORD on a phrase is shown after it in parentheses):

- (21) XP-T (-) → XP (-) XP (+)  
 XP-M (+) → XP (-) XP (+)  
 XP-B (+) → *conj* XP (-)

These rules license the following phrase structure:

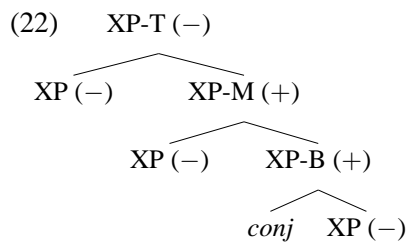

#### 4.1.2 Poly- and Asyndeton

The rules that define poly- and asyndeton strategies, perhaps surprisingly, are very similar to each other; the only difference between the two strategies is that an asyndeton strategy will have a unary bottom rule instead of one that introduces a conjunction or other coordination mark. In both cases, there is no mid rule. The rules for lexically marked polysyndeton are as follows:

- (23) XP-T (-) → XP (-) XP (+)  
 XP-B (+) → *conj* XP (-)

The rules for asyndeton (note the lack of a conjunction in the bottom rule) are as follows:

- (24) XP-T (-) → XP (-) XP (+)  
 XP-B (+) → XP (-)

For a lexically marked polysyndeton strategy, the rules in (23) license the following phrase structure. Note how the lack of a mid rule forces the alternation of the top and bottom rules, which in turn requires the appearance of the correct number of conjunctions:

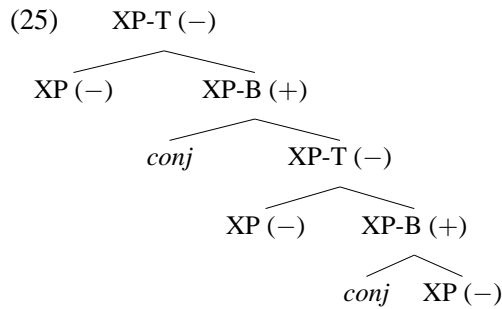

Similarly, the rules in (24) license the following structure for an asyndeton strategy:

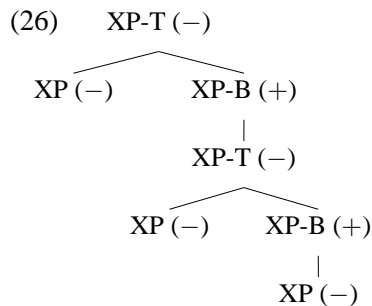

#### 4.1.3 Omnisyndeton

Omnisyndeton strategies, in which coordination of  $n$  elements requires  $n$  marks, call for a somewhat different approach. The Matrix defines the coordination structures for omnisyndeton using the following rules:

- (27) XP-T (-) → XP-B (+) XP (+)  
 XP-M (+) → XP-B (+) XP (+)  
 XP-B (+) → conj XP (-)

Note that, unlike the previous rule paradigms, for omnisyndeton the top and mid rules explicitly require a bottom phrase as their left daughter. This ensures that every coordinand is marked:

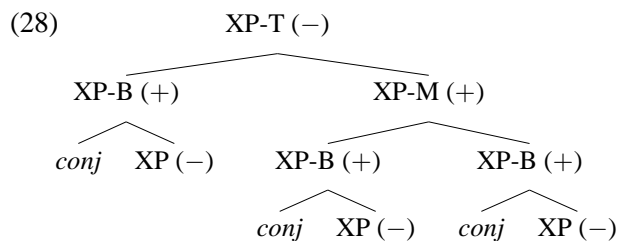

As we will see below, the semantics of omnisyndeton require an additional distinction to be made between the rightmost bottom phrase and all the others.

## 4.2 Coordination Semantics

The Matrix’s semantic representation for the coordination of an unbounded number of elements is handled in the same way as the syntax: one or more binary relations are arranged in a right-branching tree that simulates an  $n$ -way flat structure. To this end, we define a relation that coordinates two arguments:

(29)  $\left[ \begin{array}{ll} \text{LBL} & \textit{handle} \\ \text{C-ARG} & \textit{coord-index} \\ \text{L-HNDL} & \textit{handle} \\ \text{L-INDEX} & \textit{individual} \\ \text{R-HNDL} & \textit{handle} \\ \text{R-INDEX} & \textit{individual} \end{array} \right]$

In addition to dealing with any marking, it is the role of the bottom phrase to contribute a coordination relation associated with its marking conjunction or morpheme, such as *\_and\_coord\_rel*). We define a new feature **COORD-REL**, also on *local-min*, that is used to store the *coordination-relation* contributed by a phrase. This relation’s left and right arguments are left unspecified by the bottom rule; instead, they are identified in the rule licensing the bottom phrase’s parent (either a mid or a top rule).

In addition to the coordination relation supplied by the bottom phrase, each mid phrase contributes an *implicit-coord-rel* that serves to link more-than-two-way coordination. For example, three-way coordination in a strategy including a mid phrase would be represented as follows (with the identification of the L-INDEX and R-INDEX represented by branches in the tree):

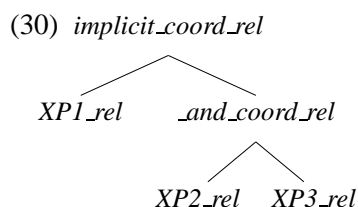

Below are the portions of the feature structures that define the semantic representations of the Matrix’s basic coordination structures:<sup>7</sup>

<sup>7</sup>It is worth pointing out that these feature structures only refer to indices and not to handles. We believe NP coordination should not constrain the handles of the coordinands because the handle of an NP is the handle of a quantifier, and in MRS nothing should constrain the handle of a quantifier. Therefore, these generic rules, from which all phrase types’ coordination strategies derive, do not constrain the handles. The handles are identified in non-NP phrase types by deriving from a type called *event-coord-phrase* (not shown here). Thanks to Ivan Sag for pointing out this missing detail.



$$(31) \left[ \begin{array}{l} \textit{topormid-coord-phrase} \\ \text{C-CONT} \mid \text{HOOK} \quad \left[ \begin{array}{l} \text{LTOP} \quad \boxed{1} \\ \text{INDEX} \quad \boxed{2} \end{array} \right] \\ \text{LCOORD-DTR} \quad \left[ \text{SYNSEM} \mid \text{LOCAL} \mid \text{CONT} \mid \text{HOOK} \mid \text{INDEX} \quad \boxed{3} \right] \\ \text{RCOORD-DTR} \quad \left[ \text{SYNSEM} \mid \text{LOCAL} \quad \left[ \begin{array}{l} \text{COORD-REL} \quad \left[ \begin{array}{l} \text{CONT} \mid \text{HOOK} \mid \text{INDEX} \quad \boxed{4} \\ \text{LBL} \quad \boxed{1} \\ \text{C-ARG} \quad \boxed{2} \\ \text{L-INDEX} \quad \boxed{3} \\ \text{R-INDEX} \quad \boxed{4} \end{array} \right] \end{array} \right] \right] \end{array} \right]$$

$$(32) \left[ \begin{array}{l} \textit{mid-coord-rule} \\ \text{SYNSEM} \mid \text{LOCAL} \mid \text{COORD-REL} \quad \textit{implicit-coord-rel} \end{array} \right]$$

$$(33) \left[ \begin{array}{l} \textit{bottom-coord-phrase} \\ \text{CONJ-DTR} \quad \textit{sign} \\ \text{NONCONJ-DTR} \quad \textit{sign} \end{array} \right]$$

$$(34) \left[ \begin{array}{l} \textit{unary-bottom-coord-rule} \\ \text{SYNSEM} \mid \text{LOCAL} \quad \left[ \text{COORD-REL} \quad \boxed{1} \right] \\ \text{C-CONT} \quad \left[ \begin{array}{l} \text{HOOK} \quad \left[ \text{INDEX} \quad \boxed{2} \right] \\ \text{RELS} \quad \langle \boxed{1} \rangle \\ \text{HCONS} \quad \langle \rangle \end{array} \right] \\ \text{NONCONJ-DTR} \quad \boxed{3} \\ \text{ARGS} \langle \boxed{3} \left[ \text{SYNSEM} \mid \text{LOCAL} \mid \text{CONT} \mid \text{HOOK} \mid \text{INDEX} \quad \boxed{2} \right] \rangle \end{array} \right]$$

$$(35) \left[ \begin{array}{l} \textit{binary-bottom-coord-rule} \\ \text{SYNSEM} \mid \text{LOCAL} \quad \left[ \text{COORD-REL} \quad \boxed{1} \right] \\ \text{C-CONT} \quad \left[ \begin{array}{l} \text{HOOK} \quad \left[ \text{INDEX} \quad \boxed{2} \right] \\ \text{RELS} \quad \langle \rangle \\ \text{HCONS} \quad \langle \rangle \end{array} \right] \\ \text{CONJ-DTR} \quad \left[ \begin{array}{l} \textit{conj-lex} \\ \text{SYNSEM} \mid \text{LKEYS} \mid \text{KEYREL} \quad \boxed{1} \end{array} \right] \\ \text{NONCONJ-DTR} \quad \left[ \text{SYNSEM} \mid \text{LOCAL} \mid \text{CONT} \mid \text{HOOK} \mid \text{INDEX} \quad \boxed{2} \right] \end{array} \right]$$

The inheritance relationships among these types and the types in (17) through (19) above are shown in the following trees:

(36)

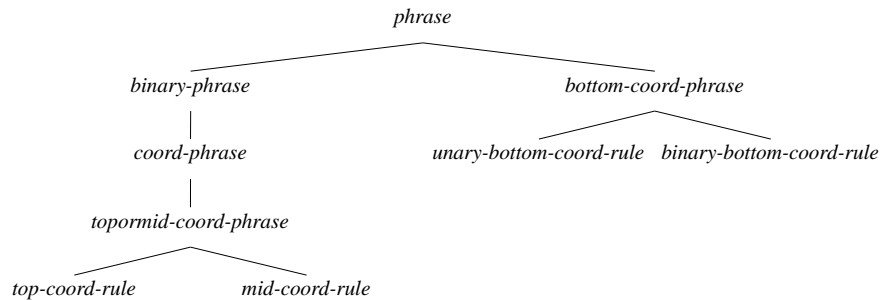

The semantic representations produced by these types are consistent across different marking types and strategies. For example, the coordination of three verb phrases using any strategy produces a representation something like the following:

(37)

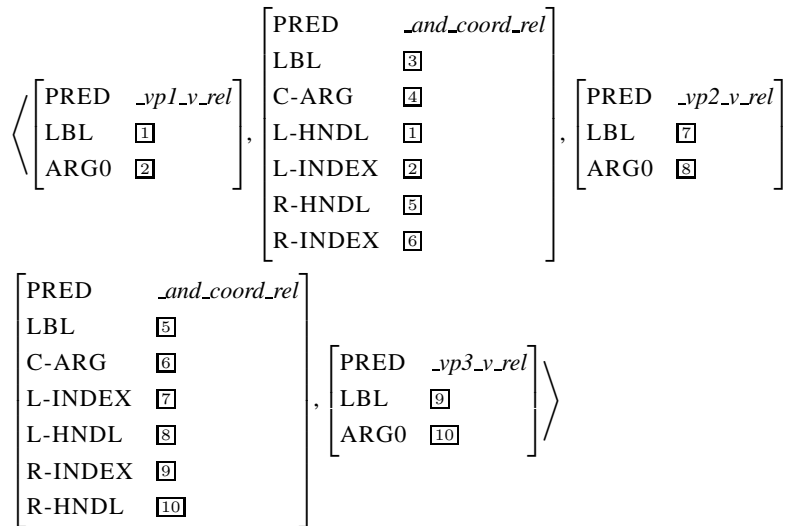

The similarity of the semantic representation for various coordination strategies enables, among other things, generation with multiple coordination strategies. Consider a language with two strategies for VPs. If we parse a sentence with coordinated VPs and then generate from the semantic representation produced, we will get (at least) two sentences: one in which the coordination is marked with the first strategy, and one in which it is marked with the second.

Omnisyndeton strategies present a problem for this approach: they have the same number of bottom phrases as they have coordinands; therefore, there are one too many *coordination-relations*. This means that omnisyndeton must be handled slightly differently. The rule for the rightmost bottom phrase requires a conjunction or morpheme with the same spelling as the conjunction or morpheme that marks the strategy, but which is semantically empty. We also define a new kind of bottom phrase, which we call a “left” phrase, with the usual semantics, and make the omnisyndeton top and mid rules require a left phrase as their left daughter:

- (38) XP-T (-) → XP-L (-) XP (+)  
 XP-M (+) → XP-L (-) XP (+)  
 XP-B (+) → conj XP (-)

The result is a semantic structure for an omnisyndeton coordination strategy that is exactly the same as for the other strategies, as in (30) above. The phrase structure assigned to a three-coordinand omnisyndeton construction is as follows:

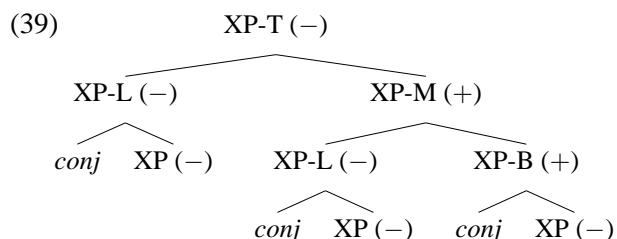

### 4.3 Summary of Implementation

The coordination module in the Grammar Matrix contains two sets of rules that support coordination: syntactic rules and semantic rules. The syntactic rules include rule paradigms for each of the marking strategies. These paradigms derive from 17–19 above, and include:

- *monopoly-top-coord-rule* and *monopoly-mid-coord-rule*, which license monosyndeton (with optional polysyndeton) marking.
- *apoly-top-coord-rule*, which licenses asyndeton and polysyndeton marking.
- *omni-top-coord-rule* and *omni-mid-coord-rule*, which license omnisyndeton marking.
- *unary-bottom-coord-rule* and *binary-bottom-coord-rule*, which license bottom phrases.

The semantic coordination rules include rule paradigms for various phrase types; for example, *basic-np-top-coord-rule*, *basic-np-mid-coord-rule*, and *np-bottom-coord-rule*, which identify the appropriate COORD-REL arguments for noun phrases.

The grammar writer, either by hand or using the Web interface, can derive coordination strategies from these rules. Each rule in the paradigm for a particular language-specific strategy will derive from two Matrix rules: one syntactic and one semantic. As an illustration, the following are the (very brief) type definitions output by the Web interface in order to license an English-like lexical monosyndeton NP coordination strategy:<sup>8</sup>

<sup>8</sup>The feature COORD-STRAT, which has not been discussed, serves to prevent the interference of rule paradigms for strategies that cover the same phrase type. For example, if the target language has two NP strategies, many ambiguous parses would be licensed if mid phrases from the first strategy could be the RCOORD-DTR of top phrases from the second strategy.

```

(40) np1-top-coord-rule :=
      basic-np-top-coord-rule &
      monopoly-top-coord-rule &
      [ SYNSEM.LOCAL.COORD-STRAT "1" ].
np1-mid-coord-rule :=
      basic-np-mid-coord-rule &
      monopoly-mid-coord-rule &
      [ SYNSEM.LOCAL.COORD-STRAT "1" ].
np1-bottom-coord-rule :=
      conj-first-bottom-coord-rule &
      np-bottom-coord-phrase &
      [ SYNSEM.LOCAL.COORD-STRAT "1" ].

```

## 5 Sample Analysis

In this section, we provide a sketch of an analysis of coordination of verb phrases and noun phrases in Ono, a Trans-New Guinea language. As described by Phinmore (1988), Ono noun phrases are coordinated with monosyndetic *so*, as in (41), while verb phrases are coordinated by inflecting non-final verbs into a “medial” form, as in (42).

(41) koya so kezong-no numa len-gi  
rain and clouds-ERG way block-3sDS  
‘Rain and clouds block the way...’ (Phinmore, 1988, 100)

(42) mat-ine gelig-e taun-go ari more zoma ka-ki so  
village-his leave-MED town-to go-MED then sickness see-him-3sDS and  
ea seu-ke  
there die-fp.-3s  
‘He left his village, went to town, and got sick and died there.’ (Phinmore, 1988, 109)

We handle the NP coordination strategy with three rules: *np-top-coord-rule*, *np-mid-coord-rule*, and *np-bottom-coord-rule*. These inherit from both the Matrix’s generic NP coordination rules and from the rules for monosyndetic, lexically-marked coordination. This is almost enough to produce a working coordination strategy; all that remains is to specify in the derived NP bottom rule that the lexical item *so* is required as the left daughter.

The VP rules are more interesting. There will be two derived rules: *vp-top-coord-rule* and *vp-bottom-coord-rule*. They derive from the generic VP rules provided by the Matrix and from the rules for asyndeton (hence the lack of a mid rule). The VP bottom rule is unary, because in this strategy the last coordinand is unmarked. The top rule, on the other hand, must specify somehow that its left daughter is in the medial form. If we assume a boolean head feature MEDIAL

whose value is + for medial verbs and verb phrases, then all the top rule needs to specify is that its left daughter's head is [MEDIAL +].

So, although the Ono VP coordination strategy is marked by pattern that may seem not, at first glance, to be covered by the Matrix's rule paradigms, the two VP coordination rules are in fact quite straightforward. They simply derive from the appropriate Matrix generic rules, with the following additional features specified:

(43)	<i>vp-top-coord-rule</i> SYNSEM   LOCAL   CAT   HEAD  LCOORD-DTR   SYNSEM   LOCAL   CAT   HEAD  RCOORD-DTR   SYNSEM   LOCAL   CAT   HEAD	<table style="border-collapse: collapse; width: 100%;"> <tr> <td style="border-right: 1px solid black; padding: 2px 5px;"><i>verb</i></td> <td style="padding: 2px 5px;">VFORM</td> <td style="border-left: 1px solid black; padding: 2px 5px;">[1]</td> </tr> <tr> <td style="border-right: 1px solid black; padding: 2px 5px;"></td> <td style="padding: 2px 5px;">TAM</td> <td style="border-left: 1px solid black; padding: 2px 5px;">[2]</td> </tr> <tr> <td style="border-right: 1px solid black; padding: 2px 5px;"><i>verb</i></td> <td style="padding: 2px 5px;">VFORM</td> <td style="border-left: 1px solid black; padding: 2px 5px;">[1]</td> </tr> <tr> <td style="border-right: 1px solid black; padding: 2px 5px;"></td> <td style="padding: 2px 5px;">TAM</td> <td style="border-left: 1px solid black; padding: 2px 5px;">[2]</td> </tr> <tr> <td style="border-right: 1px solid black; padding: 2px 5px;"></td> <td style="padding: 2px 5px;">MEDIAL</td> <td style="border-left: 1px solid black; padding: 2px 5px;">+</td> </tr> <tr> <td style="border-right: 1px solid black; padding: 2px 5px;"><i>verb</i></td> <td style="padding: 2px 5px;">VFORM</td> <td style="border-left: 1px solid black; padding: 2px 5px;">[1]</td> </tr> <tr> <td style="border-right: 1px solid black; padding: 2px 5px;"></td> <td style="padding: 2px 5px;">TAM</td> <td style="border-left: 1px solid black; padding: 2px 5px;">[2]</td> </tr> <tr> <td style="border-right: 1px solid black; padding: 2px 5px;"></td> <td style="padding: 2px 5px;">MEDIAL</td> <td style="border-left: 1px solid black; padding: 2px 5px;">-</td> </tr> </table>	<i>verb</i>	VFORM	[1]		TAM	[2]	<i>verb</i>	VFORM	[1]		TAM	[2]		MEDIAL	+	<i>verb</i>	VFORM	[1]		TAM	[2]		MEDIAL	-
<i>verb</i>	VFORM	[1]																								
	TAM	[2]																								
<i>verb</i>	VFORM	[1]																								
	TAM	[2]																								
	MEDIAL	+																								
<i>verb</i>	VFORM	[1]																								
	TAM	[2]																								
	MEDIAL	-																								

This rule identifies several features of the coordinated VPs beyond what the generic rules specify. This right-branching structure of coordination is enforced as usual by the COORD feature, so it is not necessary to specify MEDIAL on the mother node, which can only serve as the RCOORD-DTR of any further higher coordination. The structure assigned the coordination of three VPs, the first two of which are in medial form (and labeled VP-medial), is shown in (44).

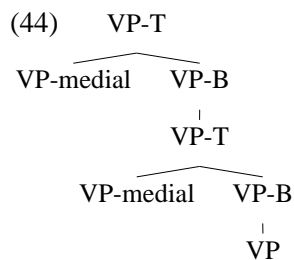

## 6 Predictions and Theoretical Implications

This analysis of coordination makes typological predictions. First, because our coordination structures are right-branching, they would not naturally accommodate a language that marks coordination only on the first coordinand: “*conj* A B C”. However, that pattern is apparently unattested (Stassen, 2000). Thus, the theory of

coordination we have implemented matches the typological distribution of coordination strategies.<sup>9</sup>

There is something odd about our coordination structures: we use the feature COORD to separate the syntactic space into two domains: the simulated N-way coordination structures, and everything else (regular syntax). This is a powerful tool, but it means that some nodes in the tree do not necessarily correspond to constituents. We also have rules in the omnisyndeton paradigm that require a particular *type* of daughter phrase, not just a phrase with a particular HEAD type. This not the way things are usually done in HPSG (it is certainly not “head-driven”), but we only do it inside of our coordination structures, and it has the not inconsiderable virtue of producing the right result.

Our analysis also makes some predictions about ambiguity. Monosyndeton languages seem to *always* optionally allow polysyndeton—although the semantics will presumably differ—and our analysis does likewise. In fact, it posits multiple structures for mono-, poly-, and asyndeton strategies:

(45) [[A conj B] conj C] vs. [A conj [B conj C]]

It does not do so, however, for omnisyndeton strategies: the second reading above would require a different surface string:

(46) [conj [conj A conj B] conj C]

It would be interesting to know if this prediction is borne out in natural languages with the omnisyndeton strategy: does this sort of “conjunction stacking” actually occur?

Finally, the Matrix’s coordination analysis makes what might be an incorrect prediction about ambiguity. Recall that we treat right-branching coordination structures as unmarked, but left-branching grouping as exceptional. Surely, however, there are three possible readings:

(47) [A and B and C] (flat)  
[[A and B] and C] (left-branching)  
[A and [B and C]] (right-branching)

If all three of these readings really are available, and in particular if the flat and right-branching readings can be distinguished, then we are failing to capture all the possible semantic representations.

---

<sup>9</sup>Note that if this pattern *were* attested, we could address it by having both left- and right-branching versions of the rules. That is, another theory is possible, but the current one seems to fit the facts.

## 7 Conclusion and Outlook

We have presented an overview of an initial version of a coordination module for the Grammar Matrix. We believe that it is suited to providing syntactically and semantically valid analyses of the diverse coordination strategies in the world's languages. Furthermore, the factored representation given to the underlying types used to create language-specific coordination systems provides a means of formalizing generalizations across languages.

The next steps for this project include testing the coverage of the module by deploying them in implemented grammars for a diverse range of languages, refining and extending the user interface presented to the grammar-writer, and expanding the coverage to include other types of coordination. In particular, we note that there are a wide variety of coordination phenomena not currently covered, including but not limited to: adversative (“but”) coordination, which seems limited to two coordinands; correlative conjunctions (e.g. “both...and”); and complex phenomena such as gapping and non-constituent coordination.

Those interested in seeing this project in action are invited to visit our web site, where they can generate a simple but functional grammar for their language of study. The URL for the site is:

<http://depts.washington.edu/uwcl/HPSG2005/modules.html>

## References

- Abeillé, Anne. 2003. A Lexicalist and Construction-Base Approach to Coordinations. In Stefan Müller (ed.), *Proceedings of HPSG03*, Stanford: CSLI.
- Beavers, John and Sag, Ivan A. 2004. Ellipsis and Apparent Non-Constituent Coordination. In Stefan Müller (ed.), *Proceedings of HPSG04*, pages 48–69, Stanford: CSLI.
- Bender, Emily M. and Flickinger, Dan. 2005. Rapid Prototyping of Scalable Grammars: Towards Modularity in Extensions to a Language-Independent Core. In *Proceedings of the 2nd International Joint Conference on Natural Language Processing IJCNLP-05*, Jeju Island, Korea.
- Bender, Emily M., Flickinger, Dan and Oepen, Stephan. 2002. The Grammar Matrix. *Proceedings of COLING 2002 Workshop on Grammar Engineering and Evaluation*.
- Borsley, Robert D. 2005. Against ConjP. *Lingua* 115, 461–482.
- Copestake, Ann. 2002. *Implementing Typed Feature Structure Grammars*. Stanford: CSLI.

- Copestake, Ann, Flickinger, Daniel P. and Sag, Carl Pollard Ivan A. 2003. Minimal Recursion Semantics. An Introduction.
- Dalrymple, Mary and Kaplan, Ronald M. 2000. Feature Indeterminacy and Feature Resolution. *Language* 76, 759–798.
- Drellishak, Scott. 2004. *A Survey of Coordination Strategies in the World's Languages*. Masters Thesis, University of Washington.
- Flickinger, Dan. 2000. On Building a More Efficient Grammar by Exploiting Types. *NLE* 6 (1), 15–28.
- Hutchison, John P. 1981. *A reference grammar of the Kanuri language*. Madison, WI: University of Wisconsin - Madison.
- Krishnamurti, BH. and Gwynn, J. P. L. 1985. *A grammar of modern Telugu*. Delhi: Oxford University Press.
- Laylock, D. C. 1965. *The Ndu language family (Sepik district, New Guinea)*. Linguistic Circle of Canberra, Series C, No 1, Canberra: The Australian National Library.
- Payne, John R. 1985. Complex Phrases and Complex Sentences. In Timothy Shopen (ed.), *Language Typology and Syntactic Description Vol. 2: Complex Constructions*, pages 3–41, Cambridge: Cambridge University Press.
- Phinnemore, Penny. 1988. Coordination in Ono. *Language and Linguistics in Melanesia* 19, 97–123.
- Sag, Ivan A., Wasow, Thomas and Bender, Emily M. 2003. *Syntactic Theory: A Formal Introduction*. Stanford: CSLI.
- Stassen, Leon. 2000. AND-languages and WITH-languages. *Linguistic Typology* 4, 1–54.



# A new well-formedness criterion for semantics debugging

Dan Flickinger 

Stanford University

Alexander Koller 

Universität des Saarlands

Stefan Thater

Universität des Saarlands

Proceedings of the 12th International Conference on  
Head-Driven Phrase Structure Grammar

Department of Informatics, University of Lisbon

Stefan Müller (Editor)

2005

Stanford, CA: CSLI Publications

pages 129–142

Flickinger, Dan, Alexander Koller & Stefan Thater. 2005. A new well-formedness criterion for semantics debugging. In Stefan Müller (ed.), *Proceedings of the 12th International Conference on Head-Driven Phrase Structure Grammar, Department of Informatics, University of Lisbon*, 129–142. Stanford, CA: CSLI Publications. DOI: 10.21248/hpsg.2005.7. 

## Abstract

We present a novel well-formedness condition for underspecified semantic representations which requires that every correct MRS representation must be a *net*. We argue that (almost) all correct MRS representations are indeed nets, and apply this condition to identify a set of eleven rules in the English Resource Grammar (ERG) with bugs in their semantics component. Thus we demonstrate that the net test is useful in grammar debugging.

## 1 Introduction

A very exciting recent development in (computational) linguistics is that large-scale grammars which derive semantic representations for their input sentences are becoming available. For instance, the English Resource Grammar (Copestake and Flickinger, 2000) is a large-scale HPSG grammar for English which computes underspecified semantic representations in the MRS formalism (Copestake et al., 2004). It is standard to use underspecification to deal with scope ambiguities; apart from MRS, there is a number of other underspecification formalisms, such as dominance constraints (Egg et al., 2001) and Hole Semantics (Bos, 1996).

However, the increased power of the new grammars comes with a new challenge for grammar engineering: How can we be sure that all semantic outputs the grammar computes (through any combination of semantic construction rules) are correct, and how can we find and fix bugs? This problem of *semantics debugging* is an important factor in the 90% of grammar development time that is spent on the syntax-semantics interface (Copestake et al., 2001).

Grammar development systems such as the LKB implement some semantic sanity checks, which are practically useful, but rather shallow, and therefore limited in their power. On the theoretical side, there are attempts to formalise “best practices” of grammar development in a *semantic algebra* (Copestake et al., 2001), but this is quite a far-reaching project that is not yet fully implemented.

One potential alternative method for semantics debugging comes from Fuchss et al.’s recent work on *nets* (Fuchss et al., 2004). They claim that every underspecified description (written in MRS or as a dominance constraint) that is actually used in practice is a *net*, i.e. it belongs to a restricted class of descriptions with certain useful structural properties, and they substantiate their claim through an empirical evaluation on a treebank. We report further evidence for this “Net Hypothesis” here by investigating the only three non-nets in the ERG’s Semantic Test Suite in some more detail. If the Net Hypothesis is true, we can recognise a grammar rule (or combination of rules) as problematic if it produces non-nets.

In this paper, we show that such a use of nets is indeed possible. We collect all MRSs that the ERG derives for all sentences in the Rondane treebank (distributed with the ERG) and the Verbmobil sections of the Redwoods treebank (Oepen et al., 2002). Then we look for the grammar rules that are responsible for deriving the non-nets, and identify a group of eleven rules which only produce non-nets for any sentence in whose analysis they are involved. By manually inspecting these

eleven rules, we determine that they indeed all have faulty semantics components. We have manually corrected some of these rules, and the corrections have been incorporated into newer versions of the ERG.

**Plan of the paper.** We will first give a brief definition of MRS in Section 2 and of MRS nets in Section 3. Then we will state the Net Hypothesis and report evidence for it in Section 4. The core of the paper is Section 5, in which we show how we can identify semantically buggy grammar rules by looking for non-nets in corpus data. Section 6 concludes the paper and points to future work.

## 2 Minimal Recursion Semantics

We start with a an informal overview of Minimal Recursion Semantics (MRS) – for details see (Copestake et al., 2004) and (Fuchss et al., 2004). MRS is the standard scope underspecification formalism used in current HPSG grammars, such as the English Resource Grammar (Copestake and Flickinger, 2000) or grammars derived from the Grammar Matrix (Bender et al., 2002). Its purpose is to separate the problem of resolving scope ambiguities from semantics construction.

**Abstract Syntax.** An *MRS structure*, or simply *MRS* for short, consists of a set of *elementary predications (EPs)* and *handle constraints*. Elementary predications can be thought of as “labeled” first order formulas with “holes.” The idea is that an MRS describes a set of first order formulas that one can obtain by “plugging” labels into holes, while handle constraints restrict possible pluggings. Consider for instance the following MRS for the sentence “each section is also suitable as a single day tour” from the Rondane treebank:

$$\{l_0 : \text{proposition}(h_1), l_2 : \text{udef}(x, h_3, h_4), l_5 : \text{a}(y, h_6, h_7), l_8 : \text{each}(z, h_9, h_{10}), \\ l_{11} : \text{single}(x), l_{11} : \text{day}(x), l_{12} : \text{tour}(y), l_{12} : \text{compound}(x, y), \\ l_{13} : \text{section}(z), l_{14} : \text{suitable}(z), l_{14} : \text{also}, l_{14} : \text{as}(y), \\ h_3 =_q l_{11}, h_6 =_q l_{12}, h_9 =_q l_{13}, h_{10} =_q l_{14}\}$$

Terms of the form  $l : P(\dots)$  are elementary predications.  $l$  is the label of the EP, terms  $h$  on the right hand side of ‘:’ are *argument handles*, and terms  $x, y, \dots$  are ordinary first order variables. Terms of the form  $h =_q l$  are handle constraints, also called *qeq-constraints*, which specify, approximately, that  $h$  must outscope  $l$  in all scope-resolved MRS structures (see below). Note that each label can label more than one EP (e.g.  $l_{12}$  in the example). This is called an *EP-conjunction* and is interpreted as a conjunction of the formulas labelled by  $l_{12}$ . Note also that first-order variables like  $z$  are bound in quantifier EPs (here, the one labelled by  $l_8$ ) and used as bound variables in other EPs (such as the one labelled by  $l_{13}$ ).

We usually represent MRS structures as graphs (see Fuchss et al., 2004). For instance, the MRS above can be represented by the graph in Fig. 1. The nodes of the graph are the labels and argument handles of the MRS, and the solid edges correspond to EPs. EP conjunctions are represented by explicit conjunction at the graph

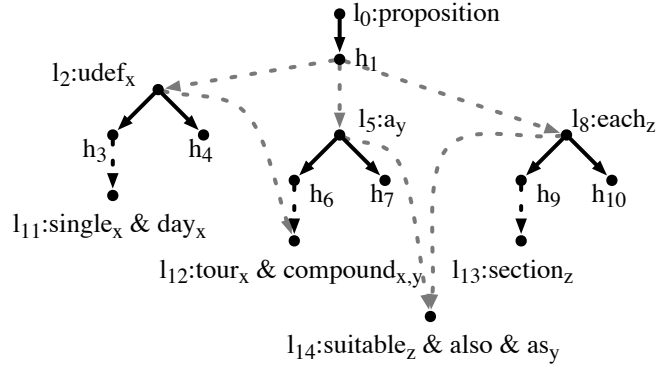

Figure 1: Graph of the MRS for “Each section is also suitable as a single day tour.”

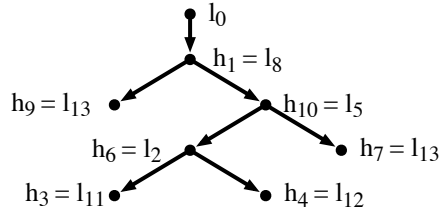

Figure 2: Configuration of the MRS in Fig. 1.

nodes. We call the subgraphs that are connected by solid edges the *fragments* of the graph. The dashed *dominance edges* are used to represent handle constraints. Dominance edges are also used to represent the implicit outscoping requirement between a variable and its binder such as between the quantifier at  $l_2$  and the variable in  $l_{12}$ , and the implicit constraint that the “top” label  $l_0$  must outscope all other EPs. It is important to note that we assume that the graph does not contain transitively redundant edges; for instance there is no dominance edge between  $l_2$  and  $l_{11}$ .

We should note that MRS structures must satisfy certain well-formedness conditions. For instance, the fragments in the graph must be tree-shaped i.e., argument handles must not occur in distinct EPs, and first order variables  $x$  must co-occur with a quantifier fragment that binds this variable.

**Semantics.** An underspecified MRS structure describes a set of *configurations*, also called *scope-resolved* MRS structures. The scope-resolved MRS structures can be computed by arranging all the fragments of an MRS structure into a tree, in such a way that every label except for the one at the root is identified with a handle, and all the outscoping requirements are respected. Fig. 2 shows one of the five scope-resolved MRSs for the MRS in Fig. 1 as an example, where we omit EPs for clarity. Note that in general it is possible that more than one label is assigned to the same handle, and that the scope-resolved MRS structure can contain more

EP conjunctions than the original MRS structure. In such a case, we call the scope-resolved MRS structure a *merging configuration*.

### 3 MRS-Nets

We now introduce (*MRS-*) *nets*, which are MRS structures that satisfy certain additional constraints.

We say that an MRS structure is an (MRS-) net if and only if every fragment in its graph satisfies the following two conditions:

1. There is exactly one node without outgoing dominance edges. All other nodes in the fragment have at least one outgoing dominance edge.
2. If a node  $X$  has two (or more) outgoing dominance edges, say, to  $Y$  and  $Z$ , then  $Y$  and  $Z$  are connected by a *hypernormal path* (see below) that does not visit the node  $X$  itself.

A *hypernormal path* in a graph is an undirected path that does not use two dominance edges that start from the same node. For instance, the following two paths are hypernormal:

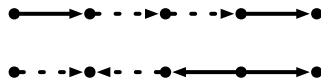

By contrast, the following path is not hypernormal:



The MRS graph shown in Fig. 1 is an example of a net. The quantifier fragments all have a single node (the “scope” of the quantifier) without outgoing dominance edges, while all other nodes have exactly one outgoing dominance edge, so they satisfy the first net-conditions; the second net condition is trivially satisfied. This is also the case for the nuclear fragments  $l_{11}, l_{12}, \dots$ , that have no outgoing dominance edges at all. The only fragment with nodes that have more than one outgoing dominance edges is the top fragment. Its dominance children are the three quantifier fragments, and there is a hypernormal path between each pair of these fragments – for instance,  $l_2, l_{12}, h_6, l_5$  and  $l_5, l_{14}, l_8$ . Hence, all fragments satisfy the two net conditions.

On the other hand, Fig. 6 shows two MRS structures which are not nets because the top fragments violate the second net condition. For example, in the first graph the top fragment has dominance edges to the fragments for “a bit” and “two young Norwegians”. But the only (undirected) path that connects these two fragments goes through the top fragment itself, and this path is not hypernormal. This graph also contains a quantifier fragment (“a bit”) which has two nodes without outgoing dominance edges and thus violates the first net condition.

The definition above is a generalisation of the original definition of nets that we gave in earlier papers (Niehren and Thater, 2003). We use it because the earlier definition involves some rather arbitrary restrictions about the allowable fragments – for example, it excludes fragments whose root has two or more outgoing dominance edges. However, all statements about nets in (Niehren and Thater, 2003) remain true for the new definition, and the proofs carry over almost verbatim. In particular, the key theorem which motivated the definition of nets remains true:

**Theorem 1 (Niehren and Thater (2003)).** *If (the graph of) an MRS is a net, then the MRS can be translated into a normal dominance constraint such that the configurations of the MRS bijectively correspond to the solved forms of the corresponding dominance constraint.*

This means that nets can be solved efficiently using the solvers for normal dominance constraints (e.g., Bodirsky et al., 2004). But nets have useful formal properties even from a pure MRS perspective. For example, it can be shown that MRS nets never have merging configurations. This means that EP conjunctions can generally be resolved in a preprocessing step, and need never be dynamically introduced by the solver.

## 4 The Net Hypothesis

Beyond these formal properties, one intriguing aspect of nets is that it is extremely hard to find useful underspecified descriptions that are not nets. This made Fuchss et al. (2004) propose the following “net hypothesis”:

**Net Hypothesis.** *All underspecified descriptions (e.g., MRS structures) that are used in practice for scope underspecification are nets.*

This hypothesis looks surprising at first glance. The intuition is that the second net condition, in particular, reflects the fact that quantifiers in underspecified representations are derived from noun phrases that are arguments of predicates like verbs or prepositions. In the underspecified representation, the arguments of such a predicate are variables which are bound by the quantifiers, and because quantifiers must outscope the variables they bind, this creates a hypernormal path between the two quantifiers. For example, the two quantifiers for “we” and “two young Norwegians” in Fig. 6 bind the arguments of the verb “meet”. If the variable  $x$ , which is bound by the quantifier “a bit”, was used anywhere else in the MRS structure (as it should be), this use would create a hypernormal connection between this quantifier and the rest of the graph; and so on.

### 4.1 Previous Evidence

One approach to determining whether the Net Hypothesis is true is to look at large corpora of MRS structures and checking whether they are nets or not. Fuchss et al.

(2004) presented a first evaluation along these lines. They considered the sentences in the Redwoods treebank (Oepen et al., 2002) and generated the MRS structures for all syntactic analyses of these sentences according to the English Resource Grammar (ERG; Copestake and Flickinger, 2000). It turned out that about 83 % of the well-formed MRS structures obtained in this way were in fact nets, while about 17 % aren't.

In addition, they evaluated a number of these non-nets manually and found that they seemed to be systematically incomplete: The MRS graphs were missing some dominance or binding edges, with the consequence that they permitted semantic readings that the original sentences didn't have. This impression was further substantiated by the fact that the average number of configurations for the non-nets was about seven times higher than for the nets.

## 4.2 Experiments with the Semantic Test Suite

There are two possible explanations for the fact that 17 % of Fuchss et al.'s MRS structures were non-nets. One is that the Net Hypothesis is wrong, and a substantial number of these non-nets are legitimate underspecified representations. The other explanation is that the Net Hypothesis is in fact true, and the non-nets result from errors in the syntax-semantics interface of the grammar, which a system of the ERG's complexity can be expected to have.

In order to shed light on this question, we performed an experiment with the MRS structures in the *Semantic Test Suite* (STS), which is distributed with the ERG grammar. This is a collection of 107 hand-constructed sentences with syntactic and semantic annotation which is used as a test suite for debugging the MRS solver in the LKB system (Copestake and Flickinger, 2000). We expected that because the MRSs in this artificial corpus are routinely examined by hand and corrected, they should tend to be less sensitive to possible errors in the grammar than a corpus of real-world text such as Redwoods. If the Net Hypothesis is true, all MRSs in the STS should be nets.

We evaluated this for the October 2004 version of the STS. It turned out that of the 107 MRS structures, only three were not nets. These resulted from the following three sentences:

- (1) The dog barked, didn't it? (sentence 77; 3 scopings)
- (2) It took Abrams ten minutes to arrive. (83; 4 scopings)
- (3) How happy was Abrams? (102; 3 scopings)

Upon closer inspection, we claim that all three MRS structures (shown in Fig. 3) are still incomplete and should really be nets. This is most obvious for (2), whose MRS graph is shown on the bottom in Fig. 3. "Ten minutes" is an argument of "take", so it is a clear error that the predicate "take" is only applied to  $y$  and not to  $x$  (the variable bound by the quantifier for "ten minutes") in the MRS.

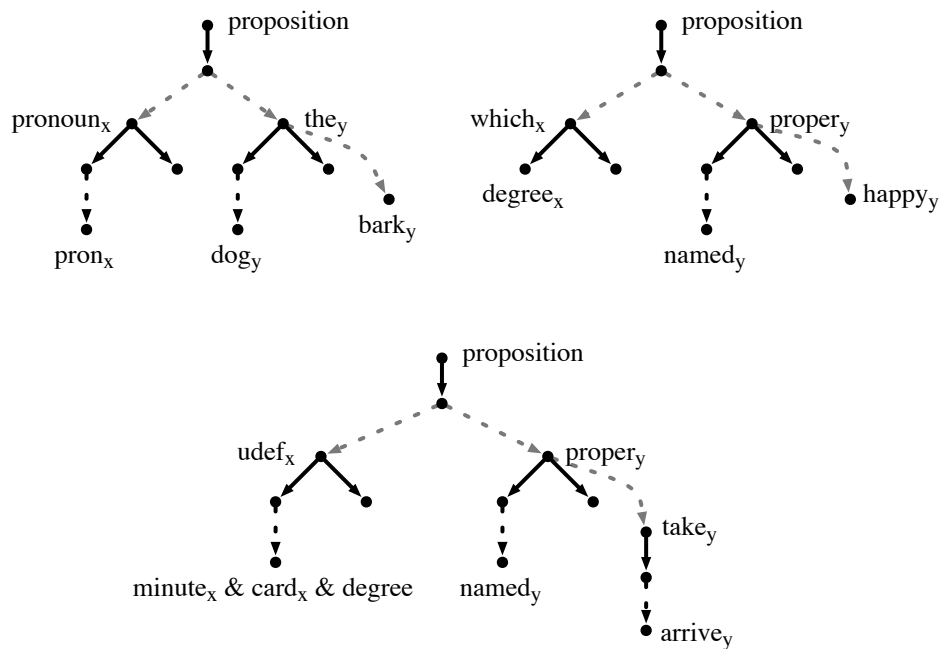

Figure 3: The three non-nets from the Semantic Test Suite.

If we add  $x$  to the “take” EP, we obtain a new dominance edge which makes the MRS into a net. Similar arguments apply for the two other sentences; for the tag question (1), one could even argue that the pronoun fragment shouldn’t even be in the semantic representation.

Although the STS is a very small corpus, it is designed to cover a range of semantic phenomena, and it is more reliably annotated with semantics than a random corpus of text. Hence we take these results as encouraging evidence that the Net Hypothesis is true.

### 4.3 A legitimate non-net

Nevertheless, we must mention that there is one type of MRS structures that seems to be linguistically plausible and still is a non-net.<sup>1</sup> One sentence of this type is

- (4) A woman the manager of whom fell ran.

A slightly simplified MRS for this sentence is shown in Fig. 4 on the left-hand side. This MRS is characterised by the fact that the two quantifiers bind variables in each other’s restrictions. It is not a net because there are two dominance edges from the root of the quantifier fragment  $a_y$  to the fragments  $manager_{x,y}$  and  $run_y$ , but the only hypernormal path that connects these two fragments goes through the root of  $a_y$ , which is not allowed in a net. On the other hand, the MRS constitutes a

<sup>1</sup>Thanks to Alex Lascarides and Ann Copestake for pointing out this example.



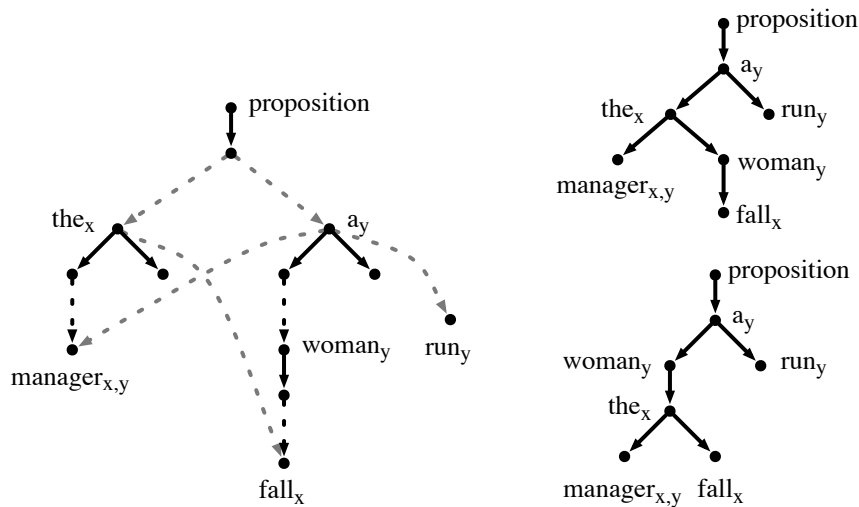

Figure 4: A linguistically legitimate non-net for the sentence “a woman the manager of whom fell ran” together with the two configurations permitted by the MRS.

plausible analysis for the sentence, as the two configurations (see Fig. 4) both are reasonable semantic representations.

However, examples of this type are extremely rare; we have not found a single MRS of this kind in the STS or the Redwoods or Rondane treebanks. In addition, the MRS in Fig. 4 can still be translated in a principled way into an equivalent normal dominance constraint which *is* a net and has the correct solved forms – although this translation is more complicated than the one used in the proof of Theorem 1. This means that there is probably a slight generalisation of nets for which the Net Hypothesis and the most important theorems about nets still hold.

## 5 Nets in Semantics Debugging

But now let’s assume that the Net Hypothesis is true – at least in a weaker form that says that *almost* all correct MRSs that are used in scope underspecification are nets. If this is the case, then the 17% non-nets that Fuchss et al. found must be due to errors in the syntax-semantics interface of the grammar. We can thus turn their finding around and use it to hunt for those rules in the grammar whose semantic components have bugs and which are responsible for generating the non-nets. In other words, we can use nets for semantics debugging.

### 5.1 Data Acquisition

The first step in this debugging process is to obtain a large collection of MRSs that are generated by the ERG. To this end, we repeated Fuchss et al.’s procedure of collecting MRSs for all parses of all sentences in the Verbmobil sections

Treebank	Sentences	Parses	Ill-formed	Non-Nets	Nets
Verbmobil (VM6)	2502	163814	33926	17921	111967
Verbmobil (VM13)	2093	159958	35634	20344	103980
Verbmobil (VM31)	1814	78332	11704	14504	52124
Verbmobil (VM32)	640	27017	3386	5280	18351
Rondane	805	38634	4381	5255	28998

Figure 5: Distribution of MRS structures for all parses of all sentences in the treebanks.

of the Redwoods 5 Treebank (Jan. 2005; 10503 sentences), and the Rondane Treebank (1034 sentences) distributed with the ERG, by parsing the sentences extracted from the treebank and extracting the MRS structures from the parses. We used the October 2004 version of the ERG. The numbers of sentences that could be parsed and the total numbers of parses (and therefore, MRSs) are shown in Fig. 5. This gave us a base number of almost half a million MRSs to work with.

We classified each sentence in the treebanks into one of three categories:

1. sentences whose MRS structure are not well-formed according to the shallow tests in the LKB system, such as structures containing free variables that aren't bound by any quantifier, or structures with cycles;
2. sentences whose MRS structures are well-formed according to the LKB checks, but are not nets, and
3. sentences whose MRS structures were nets.

In this way we collected about 63.000 non-nets.

The ratio of nets to non-nets among the well-formed MRS structures obtained from the Verbmobil corpora is 83 % to 17 %, so our results match those of Fuchss et al. (2004), which were based on a much smaller data set.

## 5.2 Semantic Debugging

In a second step, we then checked which rules are responsible for the introduction of the non-nets. We found that there are eleven rules which systematically derive only non-nets for all syntactic analyses of all sentences in the treebanks. These rules account for about 55% of the non-nets, and can be classified into four groups:

**Measure noun phrases:** MEASURE\_NP, BARE\_MEAS\_NP

**Coordinations of more than two conjuncts:** P\_COORD\_MID, N\_COORD\_MID

**Sentence fragments:** FRAG\_PP\_S, FRAG\_R\_MOD\_PP, FRAG\_ADJ, FRAG\_R\_MOD\_AP

**Other rules:** VPELLIPSIS\_EXPL\_LR, NUM\_SEQ, TAGLR

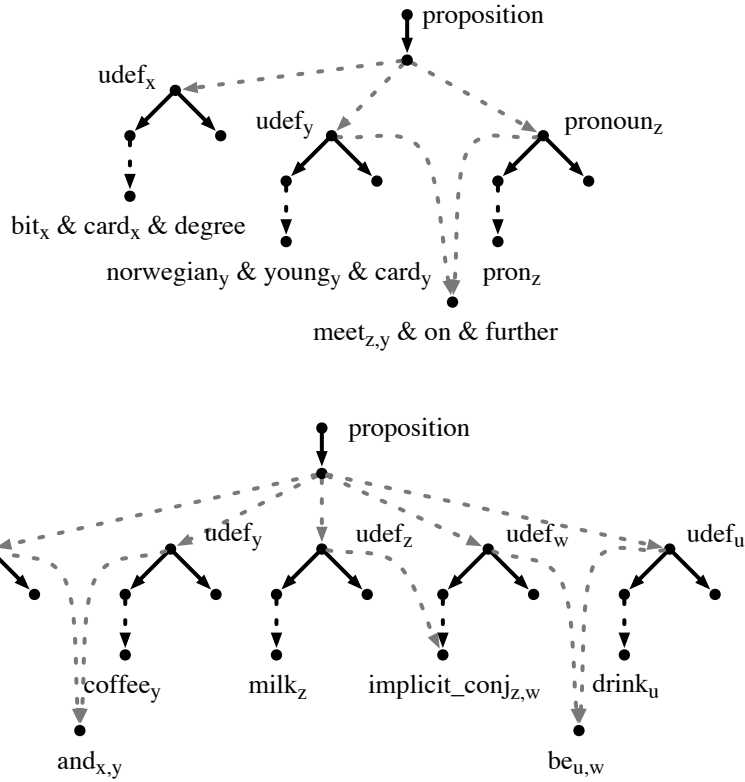

Figure 6: MRS structures for the annotated derivation for “a bit further on we meet two young Norwegians” (top) and “Drink is tea, milk and coffee” (bottom) in the Rondane treebank.

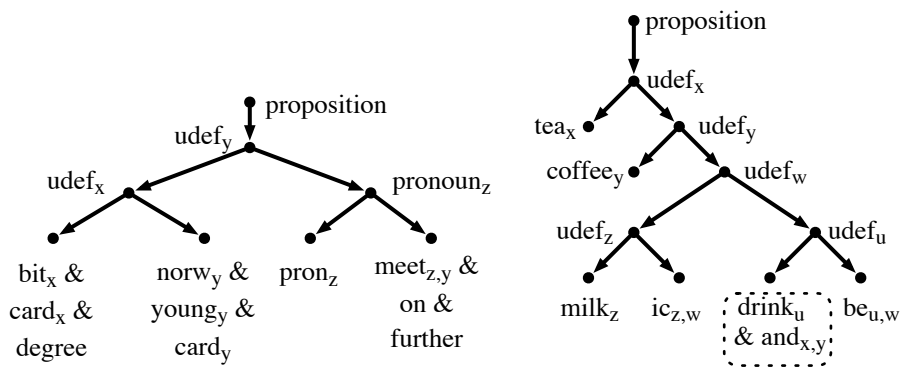

Figure 7: Configurations of the MRS structures in Fig. 6 that are meaningless as semantic representations.

We inspected these eleven rules by hand, and it turned out that indeed each of them had bugs in its semantics component. Typical bugs are that the MRSs they generate either have too few occurrences of a bound variable (which leads to missing dominance edges) or that EPs that should form a single fragment (e.g. by EP conjunction) are split into separate fragments.

Consider, by way of illustration, the two MRS structures shown in Fig. 6. The first MRS is derived by the ERG for the sentence “A bit further on we meet two young Norwegians” (Rondane 996). In this MRS, the quantifier “a bit,” whose analysis uses the MEASURE\_NP rule, introduces a bound variable  $x$  that is used only in its restriction, but in none of the predicates in its scope (“meet further on”). This is obviously not intended. Because the missing variable binding also relaxes the constraints on how fragments can be plugged together, the underspecified description admits structurally wrong readings, e.g. by plugging “young Norwegian” into the scope of “a bit” (see Fig. 7). If we fix the structure by using  $x$  in the EPs for “further on”, this introduces an additional dominance edge in the graph which makes the structure a net.

A similar bug occurs in the second MRS structure, which has been derived from the sentence “Drink is tea, milk, and coffee” (Rondane 1412) by using the N\_COORD\_MID rule. The EPs “and” and “implicit\_conj” are two different components of the same collective “tea, milk, and coffee”, and should therefore be connected. Because they aren’t, the structure has meaningless configurations such as the one shown in Fig. 7, in which “and” and “drink” have been merged into the same argument handle (and almost 1000 further configurations). If we connect “and” and “drink” either by combining them into a single EP-conjunction or by introducing additional material (e.g., a quantifier fragment) that connects the two nodes, the MRS structure again becomes a net.

A further example is the graph at the top left in Fig. 3, whose derivation uses the TAGLR rule.

### 5.3 Discussion and Analysis

To summarise, our analysis of the rules that generate non-nets pointed us towards a list of eleven rules, each of which contained bugs. What’s more, each of these rules generates *well-formed* MRS structures. This means that they could never have been found using the shallower checks that the LKB system already offers. Hence the Net Hypothesis is true enough to be useful for finding grammar rules with erroneous semantic components.

We corrected some of the rules by hand; these corrections are already part of the ERG version of February 05. The correction of the other rules is ongoing work. In order to measure the progress that this makes, we compared the number of ill-formed MRSs and non-nets before and after the correction – this time only on the parses that were actually annotated in the Rondane treebank. The result of this evaluation is shown in Fig. 8. Because the treebank contains only annotations for sentences that can be analysed by the underlying grammar, the two versions

Treebank	Sentences	Ill-formed	Non-Nets	Nets
Rondane (October 2004)	1034	7.5 %	11.1 %	81.4 %
—	942	6.8 %	10.5 %	82.7 %
Rondane (February 2005)	961	2.5 %	7.9 %	89.6 %
—	942	2.4 %	8 %	89.6 %

Figure 8: Classification of the sentences in the Rondane treebank for the original and the partially corrected version of the ERG.

of the treebank contain slightly different sets of derivation trees. To allow for a proper comparison, we report the results both for each complete treebank and for the subset of sentences that is present in both treebanks.

It turns out that the percentage of ill-formed MRSs in Rondane has dropped considerably, which is a clear indicator that the overall correctness of the MRSs has improved. In addition, the percentage of non-nets has also gone down significantly. If we only count well-formed MRSs, 92% of the MRSs in the corrected treebank are nets, which we take as further support for the Net Hypothesis.

## 6 Conclusion

We have shown that nets can be a useful tool for debugging the semantics component of a large-scale grammar. All eleven rules in the ERG that computed only non-nets turned out to be semantically problematic; a typical error was that a bound variable was not used where it should be. None of these rules could have been found easily by the existing well-formedness tests in the LKB system.

In addition, we have presented further support for the Net Hypothesis. Only three of the 107 MRS structures in the Semantics Test Suite are non-nets, and we have argued that these three MRSs are indeed missing dominance edges. Also, the partially corrected ERG derives about 90% nets on the Rondane treebank. Nevertheless, there are also (rare) MRS structures that seem to be legitimate non-nets. Generalising the definition of a net to encompass these MRSs is an important issue for future research.

The concept of a net seems to be rather complicated at first glance. However, there are portable and efficient tools for checking whether an MRS structure is a net. Utool, the Swiss Army Knife of Underspecification (Koller and Thater, 2005), can be used to solve underspecified descriptions and also implements a linear-time net test, and supports MRS as an input formalism. This tool takes less than half an hour to check which MRSs for all parses of the sentences in the Rondane treebank are nets, i.e. each MRS takes about fifty milliseconds on average. Utool is available from <http://utool.sourceforge.net>.

There are various further ways in which the work we report here could be extended. On the one hand, it would be interesting to see whether a similar debugging methodology would yield problem rules based on the LKB’s well-formedness tests,

and it would be natural to look not just for problematic *rules*, but also for problematic *lexicon entries* this way. On the other hand, we have only used a very coarse heuristic in finding the rules that are responsible for the generation of the non-nets. We suspect that some semantically problematic MRS structures are derived not by a single rule, but by a combination of rules. One way of finding such rule combinations would be to analyse the MRSs for a corpus with a decision tree learner, which would try to derive rules that capture such combinations.

## References

- Bender, Emily M., Flickinger, Dan and Oepen, Stephan. 2002. The Grammar Matrix: An Open-Source Starter-Kit for the Rapid Development of Cross-Linguistically Consistent Broad-Coverage Precision Grammars. In J. Carroll, N. Oostdijk and R. Sutcliffe (eds.), *Proceedings of the Workshop on Grammar Engineering and Evaluation at the 19th COLING*, Taipei, Taiwan.
- Bodirsky, M., Duchier, D., Niehren, J. and Miele, S. 2004. A New Algorithm for Normal Dominance Constraints. In *Proc. SODA*.
- Bos, J. 1996. Predicate Logic Unplugged. In *Proc. 10th Amsterdam Colloquium*, pages 133–143.
- Copestake, A. and Flickinger, D. 2000. An open-source grammar development environment and broad-coverage English grammar using HPSG. In *Proc. LREC*.
- Copestake, A., Flickinger, D., Pollard, C. and Sag, I. 2004. Minimal Recursion Semantics: An Introduction. *Journal of Language and Computation* To appear.
- Copestake, A., Lascarides, A. and Flickinger, D. 2001. An Algebra for Semantic Construction in Constraint-based Grammars. In *Proc. 39th ACL*, Toulouse.
- Egg, M., Koller, A. and Niehren, J. 2001. The Constraint Language for Lambda Structures. *Journal of Logic, Language, and Information* 10, 457–485.
- Fuchss, R., Koller, A., Niehren, J. and Thater, S. 2004. Minimal Recursion Semantics as Dominance Constraints: Translation, Evaluation, and Analysis. In *Proc. 42nd ACL*, Barcelona.
- Koller, Alexander and Thater, Stefan. 2005. Efficient solving and exploration of scope ambiguities. In *Proceedings of the ACL-05 Demo Session*.
- Niehren, J. and Thater, S. 2003. Bridging the Gap between Underspecification Formalisms: Minimal Recursion Semantics as Dominance Constraints. In *Proc. 41st ACL*, Sapporo.
- Oepen, S., Toutanova, K., Shieber, S., Manning, C., Flickinger, D. and Brants, T. 2002. The LinGO Redwoods Treebank: Motivation and Preliminary Applications. In *Proc. 19th COLING*.

# A computational treatment of V-V compounds in Japanese

Chikara Hashimoto 

Kyoto University

Francis Bond 

NTT Communication Science Laboratories

Proceedings of the 12th International Conference on  
Head-Driven Phrase Structure Grammar

Department of Informatics, University of Lisbon

Stefan Müller (Editor)

2005

Stanford, CA: CSLI Publications

pages 143–156

Hashimoto, Chikara & Francis Bond. 2005. A computational treatment of V-V compounds in Japanese. In Stefan Müller (ed.), *Proceedings of the 12th International Conference on Head-Driven Phrase Structure Grammar, Department of Informatics, University of Lisbon*, 143–156. Stanford, CA: CSLI Publications. DOI: 10.21248/hpsg.2005.8. 

## Abstract

We examine how a large-scale computational grammar can account for the complex nature of Japanese verbal compounds. Previous computational Japanese grammars have tried to avoid the problem by simple solutions such as enumerating as many verbal compounds in the lexicon as possible. In contrast, we develop the analysis that is linguistically adequate and computationally tractable and thus meets the requirement of a syntactically and semantically precise natural language processing of Japanese like Bond et al. (2005). Our analysis distinguishes between two kinds of verbal compounds: syntactic compounds, which are fully productive; and lexical compounds, which are of varying productivity.

## 1 Introduction

In this study, we examine how a large-scale computational grammar can account for the complex nature of Japanese verbal compounds ( $V_1$ - $V_2$  compounds, hereafter), such as *yomi-owaru* (read-finish) ‘finish to read’. It is necessary to develop a linguistically accurate and computationally tractable analysis for  $V_1$ - $V_2$  compounds, since they are common in written documents and spontaneous speech, and, despite their surface simplicity, they show various complexities. To date, several computational Japanese grammars have been developed, but little attention has been paid to  $V_1$ - $V_2$  compounds. In fact, their approaches are either enumerating all  $V_1$ - $V_2$ s in the lexicon as if they were single words without internal structures (the exhaustive listing approach) or simply concatenating the  $V_1$  and  $V_2$  of any kind of  $V_1$ - $V_2$  without taking into account the differences in their syntactic and semantic composition (the simple concatenation approach). The former suffers from undergeneration since some patterns are very productive and moreover a  $V_1$ - $V_2$  can embed another one.

- (1) Ken-ga musuko-o [[[nade-mawasi]-tuzuke]-sobire]-kake-ta  
Ken-NOM son-ACC [[[stroke-slua]-continue]-fail]-be.about.to-PAST  
‘Ken was about to fail to continue to caress his son.’

The latter approach leads to overgeneration since not all combinations of two verbs are allowed:

- (2) a. \*yu-ga waki-age-ta  
hot.water-NOM boil-raise-PAST  
‘Water reached a full boil.’  
b. yu-ga waki-aga-tta  
hot.water-NOM boil-go.up-PAST  
‘Water reached a full boil.’

---

<sup>†</sup>We appreciate many people for helping this research. We especially thank Takao Gunji, Melanie Siegel, Dan Flickinger, Sato Satoshi and the other members of the NTT Machine Translation Research Group.



We develop the analysis of  $V_1$ - $V_2$ s that is compatible with the linguistic analyses and observations made by Kageyama (1993) and Matsumoto (1996) while being computationally tractable. The analysis is implemented in JACY (Siegel and Bender, 2002) using the LKB system (Copestake, 2002) and evaluated with the Hinoki corpus (Bond et al., 2004) and the [incr tsdb()] system (Oepen and Carroll, 2000). A slightly different version of the grammar, along with the analysis tools, is available at the Deep Linguistic Processing with HPSG (DELPH-IN) website: <http://www.delph-in.net>.

## 2 Data

$V_1$ - $V_2$ s show differences in terms of how productive they are, how their transitivity and case-marking are determined, whether or not they are compositional, and what semantic composition they undergo if they are compositional. First, as for their productivity, some  $V_1$ - $V_2$ s are very productive and allow even a phrase in the  $V_1$  position. In (4), for example, the  $V_1$ - $V_2$  headed by *sobireru* (fail) allows the phrasal  $V_1$ , *nade-te age* (stroke-TE give), while the  $V_1$ - $V_2$  headed by *mawasu* (fondle) does not.

- (3) a. Ken-ga musuko-o nade-sobire-ta  
 Ken-NOM son-ACC stroke-fail-PAST  
 ‘Ken failed to stroke his son.’
- b. Ken-ga musuko-o nade-mawasi-ta  
 Ken-NOM son-ACC stroke-fondle-PAST  
 ‘Ken caressed his son.’
- (4) a. Ken-ga musuko-o nade-te age-sobire-ta  
 Ken-NOM son-ACC stroke-TE give-fail-PAST  
 ‘Ken failed to stroke his son.’
- b.\*Ken-ga musuko-o nade-te age-mawasi-ta  
 Ken-NOM son-ACC stroke-TE give-fondle-PAST  
 ‘Ken caressed his son.’

Second, some  $V_1$ - $V_2$ s inherit  $V_2$ 's transitivity and case-marking (5), while others are given those of  $V_1$  (6).

- (5) a. Ken-ga huku-o kiru  
 Ken-NOM clothes-ACC wear  
 ‘Ken wears clothes.’
- b. huku-ga kuzureru  
 clothes-NOM get.out.of.shape  
 ‘Clothes get out of the shape.’

c. huku-ga ki-kuzureru  
 clothes-NOM wear-get.out.of.shape  
 ‘Clothes get out of the shape by someone’s wearing.’

(6) a. Ken-ga siai-ni katu  
 Ken-NOM game-DAT win  
 ‘Ken wins games.’

b. Ken-ga siai-o tuzukeru  
 Ken-NOM game-ACC continue  
 ‘Ken continues games.’

c. Ken-ga siai-ni kati-tuzukeru  
 Ken-NOM game-DAT win-continue  
 ‘Ken continues to win games.’

Third, some  $V_1$ - $V_2$ s show semantic compositionality (7), but others are highly lexicalized (8).

(7) a. Ken-ga nikki-o kaki-hazime-ta  
 Ken-NOM diary-ACC write-begin-PAST  
 ‘Ken began to write a diary.’

b. Ken-ga naki-saken-da  
 Ken-NOM cry-shout-PAST  
 ‘Ken cried and shouted.’

(8) a. Ken-ga sono-ninmu-o uti-ki-tta  
 Ken-NOM that-mission-ACC hit-cut-PAST  
 ‘Ken aborted the mission.’

b. keisatu-ga hanzai-o tori-simaru  
 police-NOM crime-ACC take-fasten  
 ‘Police control crimes.’

Finally, compositional  $V_1$ - $V_2$ s are composed in diverse ways. (9a)–(9b) correspond to (7a)–(7b), respectively.

(9) a.  $\exists x \exists y \text{begin}(x, \text{write}(x, y))$

b.  $\exists x \text{and}(\text{cry}(x), \text{shout}(x))$

Table 1: Syntactic V<sub>1</sub>-V<sub>2</sub>s vs. Lexical V<sub>1</sub>-V<sub>2</sub>s

	Syntactic	Lexical
<b>Productivity</b>	Very productive; the V <sub>2</sub> s allow almost any V <sub>1</sub> .	Not so productive; the combination of V <sub>1</sub> and V <sub>2</sub> is more restricted.
<b>Transitivity</b>	The V <sub>1</sub> 's transitivity and case-marking are passed to the V <sub>1</sub> -V <sub>2</sub> .	Either V <sub>1</sub> or V <sub>2</sub> or both participate in the determination of transitivity and case-marking.
<b>Compositionality</b>	Compositional.	Some of them show varying degrees of compositionality, but others are highly lexicalized.
<b>Semantics</b>	The semantics of V <sub>2</sub> consistently embeds V <sub>1</sub> 's semantics.	There are various kinds of semantic composition.

### 3 Analysis

#### 3.1 Linguistic Analyses

Kageyama (1993)'s insightful analysis claims that different behaviors of different V<sub>1</sub>-V<sub>2</sub>s are mostly predictable from how they are composed. He distinguishes two major types: syntactic V<sub>1</sub>-V<sub>2</sub> compounds and lexical V<sub>1</sub>-V<sub>2</sub> compounds. The two component verbs of syntactic V<sub>1</sub>-V<sub>2</sub> compounds are combined in the syntax, while lexical V<sub>1</sub>-V<sub>2</sub> compounds are formed in the lexicon. Accordingly, syntactic V<sub>1</sub>-V<sub>2</sub>s are generally as productive and compositional as ordinary phrases, but lexical V<sub>1</sub>-V<sub>2</sub>s are often irregular and idiomatic. Table 1 summarizes the characteristics of the two types in more detail.

Kageyama further divides syntactic V<sub>1</sub>-V<sub>2</sub>s into three types: Raising (e.g. V<sub>1</sub>-*kakeru* (V<sub>1</sub>-be.about.to) 'be about to V<sub>1</sub>'), Control (e.g. V<sub>1</sub>-*sobireru* (V<sub>1</sub>-fail) 'fail to V<sub>1</sub>'), and  $\bar{V}$  complementation types (e.g. V<sub>1</sub>-*tukusu* (V<sub>1</sub>-exhaust) 'work out to V<sub>1</sub>'). This is supported by, among other things, a contrast in passivizability; Raising and Control types do not allow passivization of V<sub>1</sub>-V<sub>2</sub>, while the  $\bar{V}$  type does.

- (10) hon-ga Ken-ni yomi-{\*kake/\*sobire/tukus}-rare-ta  
 book-NOM Ken-DAT read-{\*be.about.to/\*fail/exhaust}-PASS-PAST

Also, the three kinds show differences in whether V<sub>2</sub>s thematically restrict their subjects and objects.

- (11) a. *ame-ga huku-o nurasi*-{*kake/\*sobire/\*tukusi*}-*ta*  
rain-NOM clothes-acc humidify- $\overline{\{$ be.about.to/\*fail/\*exhaust $\overline{\}}$ -PAST  
‘The rain {was about/failed/worked out} to wet the clothes.’
- b. *Ken-ga atama-o hiyasi*-{*kake/sobire/\*tukusi*}-*ta*  
Ken-NOM head-ACC cool- $\overline{\{$ be.about.to/fail/\*exhaust $\overline{\}}$ -PAST  
‘Ken {was about/failed/worked out} to cool off.’

Since  $V_{2s}$  of Control (*-sobireru*) and  $\overline{V}$  (*-tukusu*) types put a thematic restriction on a subject, which the subject, *ame* (rain) in (11a), cannot satisfy, only the Raising type (*-kakeru*) is grammatical in the example. In (11b), only the  $\overline{V}$  type is ruled out since it restricts an object to something that can be exhausted, but the object, *atama*, which is a part of the idiom, *atama-o hiyasu* ‘cool off,’ cannot meet the restriction.

Matsumoto (1996) classifies lexical  $V_1$ - $V_{2s}$  into seven subtypes according to the semantic relations between  $V_1$  and  $V_2$ . Each subtype, its example and a tentative semantics of the example are depicted in (12).

- (12) a. Pair  $V_1$ - $V_{2s}$

ex) *naki-sakebu* (cry-shout)  $\cdots$  and(*shout(x)*, *cry(x)*)

*Ken-ga naki-saken-da*  
Ken-NOM cry-shout-PAST  
‘Ken cried and shouted.’

- b. Cause  $V_1$ - $V_{2s}$

ex) *yake-sinu* (burn-die)  $\cdots$  cause(*burn(x)*, *die(x)*)

*Ken-ga yake-sin-da*  
Ken-NOM burn-die-PAST  
‘Ken was burned to death.’

- c. Manner  $V_1$ - $V_{2s}$

ex) *kake-yoru* (run-come)  $\cdots$  in.manner.of(*come(x)*, *run(x)*)

*Ken-ga musuko-ni kake-yo-tta*  
Ken-NOM son-DAT run-come-PAST  
‘Ken ran up to his son.’

- d. Means  $V_1$ - $V_{2s}$

ex) *tataki-kowasu* (hit-break)  $\cdots$  by.means.of(*break(x, y)*, *hit(x, y)*)

Ken-ga sara-o tataki-kowasi-ta  
Ken-NOM dish-ACC hit-break-PAST  
'Ken battered down the dish.'

e.  $V_1$ - $V_2$ s with Deverbalized  $V_1$

ex) *sasi-semaru* (thrust-close) ··· emphasized.by(close( $x$ ), thrust)

Kiken-ga sasi-semaru  
danger-NOM thrust-close  
'Dangerous situation becomes imminent.'

f.  $V_1$ - $V_2$ s with Deverbalized  $V_2$

ex) *hare-wataru* (clear.up-cross) ··· modified.by(clear.up( $x$ ), cross)

sora-ga hare-wataru  
sky-NOM clear.up-cross  
'Skies are sunny.'

Matsumoto notes how the semantic relation determines the transitivity and the semantic composition of  $V_1$ - $V_2$  and posits a semantic analysis to deal with the phenomena. Although Matsumoto presents a precise and comprehensive analysis, it assumes fine-grained semantic notions and a complicating mapping theory. To implement this, the grammar would have to recognize which semantic relation holds between the two component verbs. But this depends heavily on world knowledge and pragmatic inference, and hence is not currently computationally tractable.

In sum, Kageyama (1993) and Matsumoto (1996) present useful analyses, but these must be revised to make them computationally tractable.

### 3.2 Computational Analysis — Proposal

Our analysis of syntactic  $V_1$ - $V_2$ s is mostly compatible with Kageyama (1993) but, as an HPSG analysis, assumes neither PRO nor government. (13) illustrates the analysis. (the V-embedding type corresponds to Kageyama's  $\bar{V}$  complementation type.)

(13) a. **Raising**

'Ken is about to read a book.'

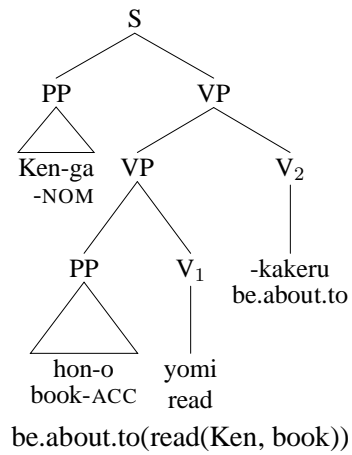

b. **Control**

'Ken fails to read a book.'

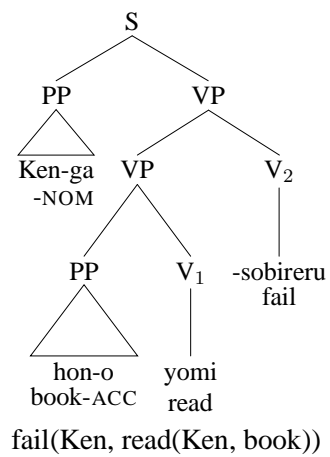

c. **V-embedding**

'Ken reads a book thoroughly.'

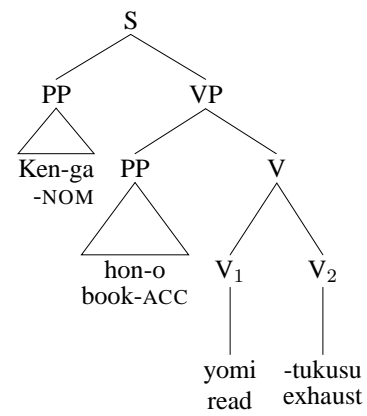

exhaust(Ken, book, read(Ken, book))

The Raising and Control structures are almost the same as those of Sag et al. (2003); the subject of Raising type  $V_2$  is “raised” from the  $V_1$ , and the subject of Control type  $V_2$  controls that of the  $V_1$ . The V-embedding type has a structure where the subject and object of the  $V_2$  control the subject and object of the  $V_1$ , respectively. These characteristics of the three are reflected in their semantic representations in (13). That is, the Raising type  $V_2$ , *kakeru* (be.about.to) in (13a), does not thematically restrict its subject, *Ken*, and object, *hon* (book), while the Control type  $V_2$ , *sobireru* (fail), puts a thematic restriction on its subject, *Ken*. The V-embedding type  $V_2$  assigns thematic roles to both the subject and object. Clearly, these differences account for (11). Note, in addition, that the Raising and Control types have a VP embedding structure, while the V-embedding type does not. The contrast in (10) is accounted for by this difference; only the object of the V-embedding type is selected by both the  $V_1$  and  $V_2$ , thus only this structure allows the passivization of  $V_1$ - $V_2$  as a whole. Other things to notice are that it is the  $V_1$  that determines the  $V_1$ - $V_2$ 's transitivity and, in most cases, case-marking, and that their semantic structures are consistently embedding structures.

One of the divergences from Kageyama (1993) involves the  $V_1$  passivization. Kageyama (1993) always accepts the  $V_1$  passivization of Control type but necessarily rules out that of his  $\bar{V}$  complementation type, based on the difference in their syntactic configurations: the VP complement vs. the  $\bar{V}$  complement. But this is incorrect as shown in (14).

- (14) a. \*hon-ga yom-are-sobireru  
book-NOM read-PASS-fail  
'A book fails to be read.'
- b. Ken-ga nagur-are-tukusu  
Ken-NOM punch-PASS-exhaust  
'Ken endures the successive punches.'

We basically allow all  $V_1$  passivizations but semantically restrict them. In (14a), for example, the subject, *hon* (book), cannot be construed as FAILER. In (14b), on the other hand, *Ken* can be interpreted as the one who exhausts himself by being punched a lot.

As for lexical  $V_1$ - $V_2$ s, we classify them into five subtypes roughly following Matsumoto (1996).

- (15) a. **Right-headed  $V_1$ - $V_2$ s**
- b. **Argument mixing  $V_1$ - $V_2$ s**
- c.  **$V_1$ - $V_2$ s with deverbilized  $V_1$**
- d.  **$V_1$ - $V_2$ s with deverbilized  $V_2$**

e. **Non-compositional V<sub>1</sub>-V<sub>2</sub>s**

The Right-headed and Argument mixing types jointly cover most of Matsumoto's Pair, Cause, Manner and Means compounds. The Non-compositional type is introduced to distinguish compositional and non-compositional V<sub>1</sub>-V<sub>2</sub>s. Unlike the finer grained semantic analysis of Matsumoto, our analysis leaves the exact semantic relationship under-specified. The constraints on composition come from an extended ARG-ST. As illustrated in (16), the ARG-ST consists of one EXTERNAL argument and two INTERNAL arguments and is classified into six types, following Imaizumi and Gunji (2000).

(16) a. 
$$\begin{bmatrix} \text{arg-st} \\ \text{EXT} & \text{index} \\ \text{INT1} & \text{index} \\ \text{INT2} & \text{index} \end{bmatrix}$$

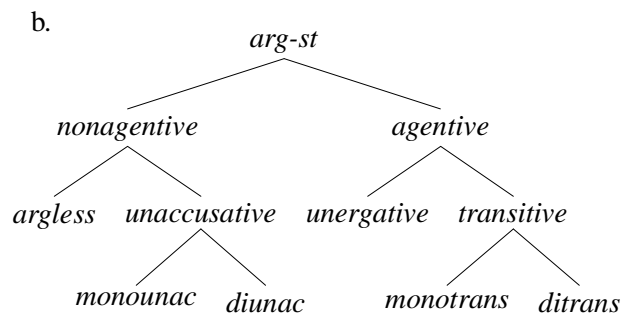

c.

	EXT	INT1	INT2
<i>argless</i>	×	×	×
<i>monounac</i>	×	○	×
<i>diunac</i>	×	○	○
<i>unergative</i>	○	×	×
<i>monotrans</i>	○	○	×
<i>ditrans</i>	○	○	○

First, the Right-headed V<sub>1</sub>-V<sub>2</sub> obeys the Shared Participant Condition proposed by Matsumoto (1996), which requires that the two component verbs share at least one argument that is co-indexed with an argument of the other component verb. Any two arguments can be co-indexed between V<sub>1</sub> and V<sub>2</sub> if the arguments agree in the EXT/INT distinction. The transitivity and case-marking of the V<sub>1</sub>-V<sub>2</sub> are inherited from the V<sub>2</sub> (hence Right-headed). The semantics is totally compositional; the two semantic representations of the V<sub>1</sub> and V<sub>2</sub> are predicated by an underspecified semantic relation, which can be specified as Pair, Cause, Manner or Means by a component outside the grammar. For example, the semantic representations of the first two V<sub>1</sub>-V<sub>2</sub>s in (12) can be glossed as *unspec\_rel(shout(x),cry(x))*



and *unspec\_rel(burn(x),die(x))*. The semantic relation cannot be fully specified in a purely syntactic account since it is affected by contexts, pragmatics, and world knowledge, as these become available, the relation can be constrained further. Research on specifying the semantic relation typically uses information about verb selectional restrictions and noun semantic classes that is not available in our grammar (Uchiyama et al., 2005).

Further, the underspecification greatly simplifies the implementation. The Right-headed  $V_1$ - $V_2$ , formulated in this way, covers most of the lexical  $V_1$ - $V_2$ s (Pair, Cause, Manner and Means of Matsumoto's) without making the grammar complicated.

Second, the Argument mixing  $V_1$ - $V_2$  has a peculiarity; it is ambiguous in that they can take arguments from either the  $V_1$  or  $V_2$ . *nomi-aruku* (drink-walk), for example, can take as the object either something to drink ( $V_1$ 's argument) or a place to walk ( $V_2$ 's argument), according to Matsumoto (1996). To account for this, we underspecify the transitivity and case-marking of the  $V_1$ - $V_2$  such that they can be inherited from either the  $V_1$  or  $V_2$ . Another peculiarity involves the fact that the  $V_2$  is restricted to a *monotrans* verb that expresses a spatial motion,<sup>1</sup> while the  $V_1$  is *transitive* and must not be a spatial motion verb. As for the semantics, it is the same as that of the Right-headed  $V_1$ - $V_2$  except that the semantic relation is always construed as Manner.

Third, the  $V_1$ - $V_2$  with deverbalized  $V_1$  includes a  $V_1$  that is deverbalized and only emphasizes the content of  $V_2$  in some way (Kageyama, 1993; Matsumoto, 1996). For instance, *sasi-semaru* (thrust-close), in our analysis, represents something like *emphasize(close(x))*. In the sense that the  $V_1$  is deverbalized, the  $V_1$ - $V_2$  is considered not fully compositional. Naturally, as the  $V_1$  is deverbalized, it is the  $V_2$  that determines the transitivity and case-marking of the  $V_1$ - $V_2$ . As Kageyama (1993) notes, there is no restriction on the possible combinations of the  $V_1$  and  $V_2$  in terms of ARG-ST.

Fourth, the  $V_1$ - $V_2$  with deverbalized  $V_2$ , as the name implies, includes a  $V_2$  that loses its original verbal meaning and takes on an adverbial meaning that modifies the  $V_1$  (Kageyama, 1993; Matsumoto, 1996). *hare-wataru* (clear.up-cross), for instance, can be glossed as *cross(clear.up(x))* in our analysis. Similarly to the  $V_1$ - $V_2$  mentioned in the last paragraph, this type of  $V_1$ - $V_2$  is also considered not fully compositional, since the  $V_2$  has lost its original verbal meaning. Regarding the transitivity and case-marking of the  $V_1$ - $V_2$ , the  $V_1$  determines them since the  $V_2$  is deverbalized. In addition, according to Kageyama (1993), the  $V_1$  and  $V_2$  of this type must agree in agentivity, unlike the  $V_1$ - $V_2$  with semantically deverbalized  $V_1$ .

The two types with a deverbalized component verb lexically encode an embedding semantic structure, similarly to the lexical treatment of the 'biclausal' nature of Japanese causatives proposed by Manning et al. (1996).

---

<sup>1</sup>In the JACY framework, a locative accusative argument is considered an object.

As for productivity, the first two types are more productive than the last two. Actually, we can freely coin a  $V_1-V_2$  that belongs to the first one, the Right-headed  $V_1-V_2$ , as long as it is semantically and pragmatically plausible. On the other hand, the Non-compositional  $V_1-V_2$  is absolutely not productive and literally non-compositional; the  $V_1-V_2$  is totally lexicalized and should be analyzed as a single word.

All in all, even though our analysis might be coarser than Kageyama (1993) and Matsumoto (1996), it is sufficient to account for  $V_1-V_2$ 's complex characteristics summarized in §2 and Table 1. Where there is insufficient information to decide the semantics we under-specify, which makes the analysis both correct and tractable.

## 4 Evaluation

To see if our implementation works well in practice, we conducted a corpus-based evaluation and examined its coverage, the amount of ambiguity, and efficiency. First, we extracted a small evaluation corpus from the Hinoki corpus (Bond et al., 2004). The evaluation corpus consists of 219 sentences, where each sentence contains at least one  $V_1-V_2$ . In addition, we prepared two versions of JACY: JACY-plain and JACY-vv. JACY-plain is given no  $V_1-V_2$  implementation but contains 1,325 lexical entries in the lexicon, which were added by the developers over the course of its development. In contrast, JACY-vv is equipped with all the  $V_1-V_2$  implementations but without any compositional  $V_1-V_2$  entries in the lexicon. Table 2 shows the results of the experiment. We find that JACY-vv gains

Table 2: Experimental results

	<b>JACY-plain</b>	<b>JACY-vv</b>
<b>Coverage (%)</b>	52.1	63.5
<b>Ambiguity (<math>\phi</math>)</b>	53.41	50.78
<b>time (<math>\phi</math>)</b>	4.85	6.43
<b>space (<math>\phi</math>)</b>	816779	995681

more coverage and less ambiguity than JACY-plain. The increased coverage is due to the remarkable productivity of the Right headed type. The reduction in ambiguity involves the more restricted nature of our approach to the free word order of Japanese. The table also shows the two versions' processing efficiency: **time** and **space**.<sup>2</sup> Adding the rules and lexical types for  $V_1-V_2$ s slightly degrades JACY-vv's efficiency. However, JACY-vv still works fast enough for practical NLP applications.

<sup>2</sup>**time** shows how long the grammar needs to parse one sentence, and **space** shows how much memory the grammar consumes to parse one sentence.

## 5 Conclusion

We have provided and implemented an analysis for Japanese verbal compounds that captures their syntactic and semantic properties. We follow Kageyama (1993) in dividing them into syntactic verbal compounds and lexical verbal compounds.

Syntactic compounds are fully compositional. There are three types: raising, control and  $\bar{V}$  complementation.

Lexical compounds are of varying compositionality. We further divided them into five subtypes depending on how their argument structures combine: right-headed, argument mixing, deverbilized  $V_1$ , deverbilized  $V_2$ , and fully lexicalized non-compositional compounds. These types make use of an extended argument structure to constrain the classes of verbs that can appear in each type.

We implemented the analyses in the JACY grammar. We then tested them against corpus data to confirm their correctness.

## References

- Bond, Francis, Copestake, Ann, Flickinger, Dan, Oepen, Stephen and Siegel, Melanie. 2005. Open Source Machine Translation with DELPH-IN. In *Proceedings of The 10th Machine Translation Summit*.
- Bond, Francis, Fujita, Sanae, Hashimoto, Chikara, Nariyama, Shigeko, Nichols, Eric, Ohtani, Akira, Tanaka, Takaaki and Amano, Shigeaki. 2004. The Hinoki Treebank — A Treebank for Text Understanding. In *Proceedings of the First International Joint Conference of Natural Language Processing*, pages 554–559.
- Copestake, Ann. 2002. *Implementing Typed Feature Structure Grammars*. CSLI Publications.
- Imaizumi, Shinako and Gunji, Takao. 2000. Complex Events in Lexical Compounds. In Tanaka Itou and Shuichi Yatabe (eds.), *Lexicon and Syntax (in Japanese)*, pages 33–59, Hitsuji Shobou.
- Kageyama, Taro. 1993. *Grammar and Word Formation (in Japanese)*. Hitsuji Shobou.
- Manning, Christopher D., Sag, Ivan A. and Iida, Masayo. 1996. The Lexical Integrity of Japanese Causatives. In Takao Gunji (ed.), *Studies in the Universality of Constraint-Based Structure Grammars*, pages 9–37, Osaka University.
- Matsumoto, Yo. 1996. *Complex Predicates in Japanese: A Syntactic and Semantic Study of the Notion ‘Word’*. CSLI Publications.

- Oepen, Stephen and Carroll, John. 2000. Performance profiling for grammar engineering. *Natural Language Engineering* pages 81–97.
- Sag, Ivan A., Wasow, Thomas and Bender, Emily M. 2003. *Syntactic Theory: A Formal Introduction*. Stanford: CSLI Publications, second edition.
- Siegel, Melanie and Bender, Emily M. 2002. Efficient Deep Processing of Japanese. In *Proceedings of the 3rd Workshop on Asian Language Resources and International Standardization*, Taipei, Taiwan.
- Uchiyama, Kiyoko, Baldwin, Timothy and Ishizaki, Shun. 2005. Disambiguating Japanese Compound Verbs. *Computer Speech and Language, Special Issue on Multiword Expressions* 19, Issue 4, 497–512.

# On non-canonical clause linkage

Anke Holler 

University of Heidelberg

Proceedings of the 12th International Conference on  
Head-Driven Phrase Structure Grammar

Department of Informatics, University of Lisbon

Stefan Müller (Editor)

2005

Stanford, CA: CSLI Publications

pages 157–177

Holler, Anke. 2005. On non-canonical clause linkage. In Stefan Müller (ed.), *Proceedings of the 12th International Conference on Head-Driven Phrase Structure Grammar, Department of Informatics, University of Lisbon*, 157–177. Stanford, CA: CSLI Publications. DOI: 10.21248/hpsg.2005.9.



## Abstract

The present paper investigates a certain subset of clause linkage phenomena and develops a constraint-based account to the empirical fact that clauses need to be distinguished w.r.t their degree of integratedness into a potential matrix clause. Considering as example German, it is shown that the generally assumed twofold distinction between main and subordinate clauses (or root and embedded clauses) does not suffice to deal with the presented data. It is argued that the discussed linkage phenomena originate from syntactic, semantic and pragmatic properties of the clauses involved, and should hence be encoded in grammar.

## 1 Introduction

In generative grammar, it is commonly assumed that clauses that can stand alone as complete sentences differ grammatically from ones that are dependent on a matrix clause and are in this respect subordinated. This difference is often expressed by a boolean feature called ROOT (or alike), and by analysing +ROOT-clauses as syntactically highest clauses. The stipulation of a ROOT feature has been motivated by an observation going back to Emonds (1970) whereby clauses vary in admitting of so-called root phenomena. Whereas +ROOT clauses support these phenomena, -ROOT clauses disallow them.<sup>1</sup>

Contrary to this assumption, Green (1996) argues that the best explanation of the acceptability of root phenomena in embedded clauses is not a syntactic, but a pragmatic one, and thus distinguishing dependent clauses from independent utterances can be done ROOT-less. Working within construction-based HPSG, Green (1996) suggests to introduce a new dimension of clauses, called DEPENDENCY, with three partitions *subordinate*, *main* and *indifferent* with most subtypes of clauses being indifferent as to whether they act as main clauses or subordinate clauses. While Green (1996) is correct in assuming that a binary feature is not justified for the distinction of main and subordinate clauses, her approach must be revised to cover dependent clauses that simultaneously behave like main and subordinate clauses with respect to their syntactic form, their interpretation, and their functional usage, and therefore indicate that a pure pragmatic account is not adequate.

The paper is structured as follows: In the next section, several non-canonical clause linkage phenomena occurring in German will be discussed which challenge any approach implementing a twofold differentiation between main and subordinate clause types. Recent HPSG seems well equipped to handle the presented data as will be shown in sec. 3. There, a constraint-based analysis will be sketched that makes use of the idea that feature structures describing clause types can be organized according to the way the respective clause is linked to its syntactic surrounding. Sec. 4 provides some concluding remarks.

---

<sup>1</sup>For a listing of these phenomena see among many others Hooper and Thompson (1973). As for German, an initial position of the finite verb is usually taken as a typical root property.

## 2 The Problem

In German, a typical SOV language, canonical subordinate clauses differ from canonical main clauses by the position of the finite verb. Whereas the finite verb in main clauses is fronted (henceforth called ‘V2’), it occurs in clause-final position (henceforth called ‘VF’) in subordinate clauses. (1) exemplifies this well-known fact.

- (1) a. Oskar ist vom Stuhl gefallen.  
*Oskar has from the chair fallen*  
‘Oskar has fallen from a chair.’
- b. Emma bezweifelt, dass Oskar vom Stuhl gefallen ist.  
*Emma doubts that Oskar from the chair fallen is*  
‘Emma doubts that Oskar is fallen from a chair.’

Data like (1) form the basis of previous HPSGian work on the classification of German clause types. The proposed analyses have in common that the position of the finite verb (i.e. V2 versus VF) is ‘hard-wired’ to the sort or the feature representing main and subordinate clauses, resp.

### 2.1 Pertinent Previous Approaches

All pertinent previous approaches to the distinction of root and subordinate clauses in German, such as Uszkoreit (1987), Kathol (1995) and Netter (1998), follow the idea that a fronted finite verb marks main clauses whereas its final position signals a subordinate clause.

Uszkoreit (1987) formulates restrictions relating the value of the boolean feature *M(AIN)C(LAUSE)* to the value of the boolean feature *INV(ERTED)* which represents the finite verb’s clausal position.

Netter (1998) implements a correspondence approach of sentence types and their respective functional meanings<sup>2</sup> by combining the verbal position and the root-subordinate distinction. He stipulates sorts of the following kind: *V-2 Declarative Main*, *V-Final Declarative Subordinate*, *V-2 Interrogative Main*, *V-Final Interrogative Subordinate*, etc.

The most elaborated account within HPSG is the one of Kathol (1995). As fig. 1 shows, he introduces two subsorts of the sort *clause*, called *root* and *subordinate*, which are cross-classified with sorts representing function types such as *interrogative*, *declarative* and *imperative*. The sort *root* is further partitioned by the sorts *v1* and *v2* reflecting the two possible clause-initial positions of a finite verb. Tracing the traditional descriptive model of Topological Fields, cf. Drach (1937), Kathol (1995) formulates a set of constraints on constituent order domains, cf. Reape (1994), such that the finite verb is restricted to a particular topological field in dependence of the respective sort representing a clause type. Thus, for any

---

<sup>2</sup>For a critical evaluation of such an approach, see Reis (1999).

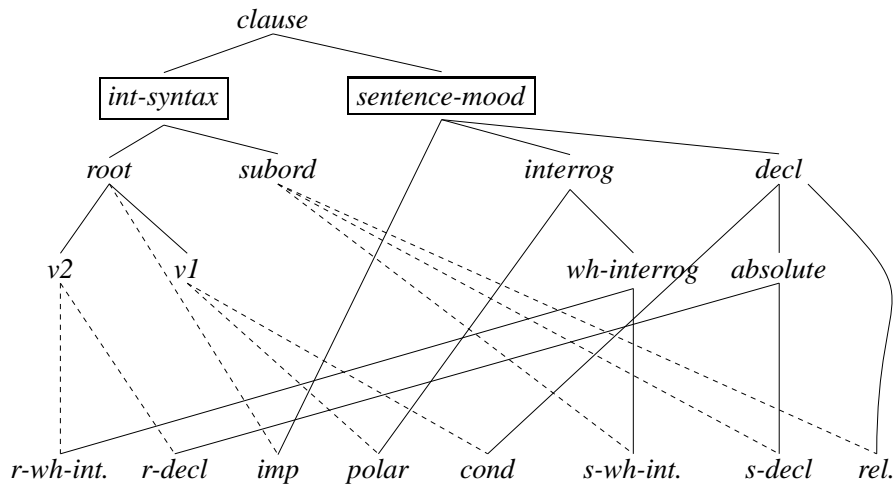

Figure 1: Sort hierarchy of *clause* taken from Kathol (1995)

clause of sort *subordinate* the finite verb has to be in clause final position whereas the finite verb of clauses of sort *root* always stands in clause initial position. Additionally, Kathol (1995) assumes that clauses of sort *root* bear a PHON feature but not clauses of sort *subordinate* arguing that *root* clauses only can be uttered independently.

Splitting clause types into root and subordinate depending on the position of the finite verb and the presence or absence of PHON, as Kathol (1995) does it, yields an approach that classifies dependent V2-clauses such as (2a) as root but independent VF clauses such as (2b) as subordinate, predicting contrary to the facts that the respective V2-clause is uttered independently but not the VF one.

- (2) a. Ich glaube, er hat recht.  
*I think he has right*  
 ‘I think that he is right.’
- b. Ob er noch kommt?  
*Whether he still comes*  
 ‘I wonder whether he will still come?’

Hence, any approach that acts on a dedicated relation between the finite verb’s position and the classification as root or subordinate clause seems to be flawed. The next sections present several data of complex clause constructions showing that it seems to be reasonable to differentiate between canonical and non-canonical clause linkage in German.



## 2.2 Dependent V2-clauses

Reis (1997) has demonstrated that dependent V2-clauses like (2a) similarly show properties of clear subordinate clauses *and* clear root clauses, and thus can be assigned to either of them. As evidence she gives inter alia that dependent V2-clauses (i) are information-structurally integrated into their matrix clause signaled by a rising tone at the end of the matrix predicate, cf. example (3), (ii) admit variable binding from the matrix clause, cf. example (4), (iii) are restricted to a final position within the matrix clause, which means that they must not occur initially or in the so-called middle field, cf. example (5), (iv) disallow correlatives and *und zwar*-supplements, cf. example (6), and (v) disallow extraction, cf. example (7).<sup>3</sup> Properties (i) and (ii) are characteristic for subordinate clauses whereas the properties (iii) to (v) usually substantiate root clauses.

- (3) Ich hatte geglaubt, (/) sie käme.  
*I had believed she came*  
 ‘I had believed that she would come.’
- (4) Jeder<sub>i</sub> glaubt, er<sub>i</sub> sei der Beste.  
*Everyone believes he is the best*  
 ‘Everyone believes that he is the best one.’
- (5) a. Jeder<sub>i</sub> möchte gern glauben, er<sub>i</sub> sei unheimlich beliebt.  
*Everyone want to gladly believe he is<sub>[subj]</sub> extremely popular*  
 ‘Everyone would like to believe that he is extremely popular.’  
 b. \*Er<sub>i</sub> sei unheimlich beliebt, möchte jeder<sub>i</sub> gern glauben.  
*He is<sub>[subj]</sub> extremely popular want to everyone gladly believe*  
 c. Weil er lange geglaubt hat, sie käme, . . .  
*Because he for a long time believed has she would come*  
 ‘Because he believed for a long time that she would come.’  
 d. \*Weil er sie käme lange geglaubt hat, . . .  
*Because he she would come for a long time believed has*
- (6) a. Hans hat (\*es) geglaubt, Peter geht dahin zu Fuß.  
*Hans has (it) believed Peter goes there on foot*  
 ‘Hans believed Peter goes there on foot.’  
 b. Weil Peter (\*daran) glaubt, sie ist nett.  
*Because Peter (that) believes she is nice*  
 ‘Because Peter believes she is nice.’  
 c. \*Peter hat gestanden, und zwar er habe gleich drei Morde  
*Peter has confessed namely he has<sub>[subj]</sub> even three murders*  
 begangen.  
*committed*

<sup>3</sup>All examples are taken from Reis (1997).

One might argue that (7) shows contrary to the statement above that extraction is possible out of dependent V2-clauses. Reis (1995), however, has shown that these examples are instances of a parenthetical construction rather than cases of extraction.

- (7) a. Wo glaubst du wohnt man billig?  
*Where believe you lives one cheaply*  
 ‘Where do you believe one lives cheaply?’  
 b. In Tübingen glaubst du wohnt man billig.  
*In Tübingen believe you lives one cheaply*  
 ‘In Tübingen you believe one lives cheaply.’

Besides the mentioned properties, dependent V2-clauses differ semantically and pragmatically from subordinate *dass*-complement clauses. Reis (1997) points out that dependent V2-clauses do not realize an argument of the matrix predicate in the usual way. She argues that dependent V2-clauses are not cases of canonical semantic selection, and, thus, the theta role has to be assigned non-structurally. Further, dependent V2-clauses may not be presupposed. Also, they cannot be interpreted in scope of negation and cannot be combined with negative predicates like *bezweifeln* (‘doubt’), cf. Steinbach (1999):

- (8) a. \*Er glaubt nicht, Maria möchte das Theorem beweisen.  
*He believes not Maria wants to the theorem prove*  
 b. \*Er bezweifelt, Maria möchte das Theorem beweisen.  
*He doubts Maria wants to the theorem prove*

As functional use is concerned, dependent V2-clauses seem to be peculiar as well since they have illocutionary force. Even though their illocutionary association somehow seems to be related to the matrix clause, cf. Boettcher (1972), Reis (1997) and Meinunger (2004), the fact itself shows that the clauses cannot be ordinary embedded clauses, cf. Green (2000b).

If dependent V2-clauses were the single clausal class exhibiting the listed properties, one might seek for an idiosyncratic explanation. In German, however, there exist several types of clauses showing similar mixed properties in terms of a root-subordinate distinction, albeit occurring in miscellaneous syntactic environments.

### 2.3 Free *dass*-clauses

Reis (1997) provides evidence that the so-called free *dass*-clauses, illustrated by (9), have the properties (i) to (v) listed above.

- (9) Er muss im Garten sein, dass er nicht aufmacht.  
*He must in the backyard be that he not opens*  
 ‘He must be in the backyard since he does not open.’

This particularly means that free *dass*-clauses behave like subordinate clauses as they are integrated into the information structure of their host, cf. (10), and a quantifier can bind a variable occurring in a free *dass*-clause, cf. (11).

(10) Was ist denn HIER los, dass Max so schreit?  
*What is PART here the matter that Max like that screams*  
 ‘What is wrong here that Max screams like that?’

(11) Was hat denn jeder<sub>i</sub> hier, dass er<sub>i</sub> so rumtoben muss.  
*What has PART everyone here that he like that romp must*  
 ‘What is going on here with everyone that he has to romp like that?’

On the other hand, free *dass*-clauses show properties of typical root clauses since they are restricted to a clause final position, cf. (12), they do not allow cor-relatives or supplements, cf. (13), and there is no extraction possible out of them, cf. (14).

(12) a. Du musst verrückt sein, dass du kommst  
*You must crazy be that you come*  
 ‘You must be crazy that you come.’  
 b. \*Dass du kommst, musst du verrückt sein.  
*That you come must you crazy be*  
 c. Was ist denn gerade los, dass er so schreit?  
*What is PART just now the matter that he like that screams*  
 ‘What is wrong just now, that he screams like that?’  
 d. \*Was ist denn, dass er so schreit, gerade los?  
*What is PART that he like that screams just now the matter*

(13) a. Fritz ist (\*es) blöd, dass er kommt.  
*Fritz is (it) kind of stupid that he comes*  
 ‘Fritz is kind of stupid to come.’  
 b. \*Fritz ist blöd, und zwar dass er Ernas Nerzmantel bezahlt.  
*Fritz is stupid namely that he Erna’s mink coat pays for*

(14) a. \*Welchen Mantel ist Fritz blöd, dass er bezahlt?  
*Which coat is Fritz stupid that he pays for*  
 b. \*Den Nerzmantel ist Fritz blöd, dass er bezahlt.  
*The mink coat is Fritz stupid that he pays for*

In semantic respects, free *dass*-clauses also differ from their canonical counterparts: In contrast to ordinary *dass*-complement clauses, they clearly do not realize an argument of the matrix predicate. In addition, free *dass*-clauses share with dependent V2-clauses that they cannot be interpreted in the scope of negation or negative predicates. That free *dass*-clauses denote facts is likely to be the reason for this.

- (15) a. \* Was ist denn nicht los, dass er so schreit?  
*What is PART not the matter that he like that screams*
- b. \* Er bezweifelt, dass Fritz blöd ist, dass er Erna den Nerzmantel kauft.  
*He doubts that Fritz stupid is that he for Erna the mink coat buys*

In pragmatic respects, free *dass*-clauses are illocutionary independent as well. Based on the fact they denote, they express a presumption or an assessment.

## 2.4 V2-relative clauses

There is another class of clauses that behaves all about the same as dependent V2-clauses and free *dass*-clauses, the so-called V2-relatives. An example of this clausal class is given in (25).<sup>4</sup>

- (16) Das Blatt hat eine Seite, die ist ganz schwarz.  
*The sheet has one side that is completely black*  
 ‘The sheet has one side that is completely black.’

Gärtner (2001) who thoroughly investigated V2-relatives argues that they are restrictive relative clauses similarly showing properties of typical root and subordinate clauses. A brief outline of his argumentation is presented in the following.

Like dependent V2-clauses and free *dass*-clauses, V2-relatives strictly remain clause final. Thus, they neither can be topicalized nor undergo A-movement as demonstrated by (17).

- (17) a. Ich suche jemanden, den nennen sie Wolf-Jürgen.  
*I look for someone who call they Wolf-Jürgen*  
 ‘I’m looking for someone who they call Wolf-Jürgen.’
- b. \* Jemanden, den nennen sie Wolf-Jürgen, suche ich.  
*Someone who call they Wolf-Jürgen look for I*
- c. Ich höre, dass jemand gesucht wird, der heißt Wolf-Jürgen.  
*I hear that someone looked for is who is called Wolf-Jürgen*  
 ‘I hear that someone is being looked for who they call Wolf-Jürgen.’
- d. \* Ich höre, dass jemand, der heißt Wolf-Jürgen, gesucht wird.  
*I hear that someone who is called Wolf-Jürgen looked for is*

Example (18) illustrates that V2-relatives always follow the finite verb of an embedded V-final clause, which means that they are not adjacent to the DP they seem to modify.<sup>5</sup> (19) indicates that V2-relatives are ordered last with respect to extraposed clauses that modify the same clause as the relative clause.

<sup>4</sup>All examples in this section are taken from Gärtner (2001).

<sup>5</sup>The coordinative construction (i) indicates that clause-finality is not a purely linear but a structural property.

- (18) a. Es gibt Tage, an denen wir etwas erleben, das irritiert  
*There are days on which we something experience that bothers*  
 uns.  
*us*  
 ‘There are days on which we experience something that bothers us.’
- b. \*Es gibt Tage, an denen wir etwas, das irritiert uns,  
*There are days on which we something that bothers us*  
 erleben.  
*experience*
- (19) a. Ich las von einer Stadt, als ich klein war, deren Häuser sind  
*I read about a town when I a child was which houses are*  
 aus Gold.  
*of gold*  
 ‘When I was a child, I read about a town the houses of which are made  
 of gold.’
- b. \*Ich las von einer Stadt, deren Häuser sind aus Gold, als ich  
*I read about a town which houses are of gold when I*  
 klein war  
*a child was*

Evidence for the root-like character of V2-relatives comes not only from the  
 afore mentioned ordering facts but also from binding theory. Condition C ef-  
 fects relax in the V2-relative construction, which is illustrated by the —admittedly  
 subtle— contrast in (20).

- (20) a. In Köln traf er<sub>i</sub> Leute, die haben Hans<sub>i</sub> nicht erkannt.  
*In Cologne met he people who have Hans not recognize*  
 ‘In Cologne he met people who didn’t recognize Hans.’
- b. ?? In Köln traf er<sub>i</sub> Leute, die Hans<sub>i</sub> nicht erkannt haben.  
*In Cologne met he people who Hans not recognize have*

In addition, a quantifier cannot bind a variable in the V2-relative, cf. (21), which is  
 another indication of rootness.<sup>6</sup>

- (21) a. \*Keine Linguistin<sub>i</sub> mag Studenten, die zitieren sie<sub>i</sub> nicht.  
*No linguist likes students who cite her not.*
- b. Keine Linguistin<sub>i</sub> mag Studenten, die sie<sub>i</sub> nicht zitieren.  
*No linguist likes students who her not cite*  
 ‘No linguist likes students who do not cite her.’

---

(i) Hans hat Freunde, die lesen gern und Peter hat Freunde, die tanzen gern.  
*Hans has friends who like reading and Peter has friends who like dancing*  
 ‘Hans has friends who like reading and Peter has friends who like dancing.’

<sup>6</sup>In this aspect, V2-relatives differ from dependent V2-clauses and free *dass*-clauses, resp.

More parallels between V2-relatives and dependent V2-clauses as well as free *dass*-clauses can be found in terms of properties characteristic for subordinate clauses: First, V2-relatives are prosodically integrated into the matrix clause as they may not be immediately preceded by intonational final boundary markings such as a falling tone or a pause. Second, V2-relatives constitute a single informational unit together with the matrix clause as shown by (22). The sentences in (22) are 'all-focus' sentences as the focus projects from the DP. DP-internally, the noun and the modifier exhibit an equal amount of stress, which in the case of a sentential modifier is realized on their main verb's complement.

- (22) a. Es gibt PhilSOpfen, (/) die kommen aus GRÖNland.  
*There are philosophers who come from Grönland*  
 'There are philosophers coming from Grönland'
- b. ... weil es PhilSOpfen gibt, (/) die kommen aus GRÖNland.  
*because there philosophers are who come from Grönland*  
 '... because there are philosophers coming from Grönland'

Gärtner (2001) further argues that V2-relatives have to be interpreted restrictively since phenomena that usually indicate restrictiveness, such as *eins*-pronominalization and modification of a predicational NP, can be observed in V2-relative constructions:

- (23) a. Hans kennt einen Philosophen, der mag Achternbusch, und Maria  
*Hans knows a philosopher who likes Achternbusch and Maria*  
 kennt auch einen.  
*knows also one*  
 'Hans knows a philosopher who likes Achternbusch and Maria also knows one.'
- b. Maria ist ein Mensch, den solltet ihr nicht unterschätzen.  
*Maria is a person who should you not underestimate*  
 'Maria is a person who you shouldn't underestimate.'

There is another peculiarity of V2-relatives also observed by Gärtner (2001): V2-relatives are limited to indefinite noun phrases, i.e. they can only modify indefinite DPs, but true quantifiers and definite descriptions cannot be accessed as an antecedent. This is illustrated by the examples in (24).

- (24) a. \* Ich kenne alle Linguisten, die haben über Toba Batak gearbeitet.  
*I know every linguist who has on Toba Batak worked*
- b. \* Ich kenne den Linguisten, der hat über Toba Batak gearbeitet.  
*I know the linguist who has on Toba Batak worked*

Last but not least, V2-relative clauses are sensitive to presuppositionality as well. Therefore, they cannot attach to a negated noun phrase as is expected.

- (25) \* Das Blatt hat keine Seite, die ist ganz schwarz.  
*The sheet has no side that is completely black*

Thus, the three clausal types, i.e. dependent V2-clauses, free *dass*-clauses and V2-relatives, behave all about the same in terms of a restricted licensing by the matrix clause. The grammatical properties of the clauses just considered indicate that their relation to a potential matrix clause is not canonical inasmuch they are not clear-cut subordinate (embedded) clauses. On the other hand, they do not show properties of well-defined main (root) clauses, either. Interestingly, there exists yet another class of dependent clauses in German that are not canonically linked to their syntactic surrounding. This class comprises at least the so-called V2-adverbial clauses, and non-restrictive relative clauses of any kind, in particular *wh*-relatives. The characteristics of these clausal constructions will be discussed in the following two sections.

## 2.5 *Weil*-V2-adverbial clauses

In German, there exists an alternative type of standard adverbial clauses introduced by *weil* ('because'), cf. (26), which are paratactic constructions and realize different speech acts than their standard counterparts. Contrary to the standard constructions which are hypotactic the finite verb is fronted in these adverbial clauses.<sup>7</sup>

- (26) Peter kommt zu spät, weil er hat keinen Parkplatz gefunden.  
*Peter comes too late because he has no parking space found*  
 'Peter is late because he could not find a parking space.'

*Weil*-V2-adverbial seem to be root clauses. This hypothesis is substantiated by work of Wegener (1993) and Uhmann (1998) who have independently shown that these clauses are characterized by a specific semantic and functional root-like behaviour which is formally manifested.<sup>8</sup>

First of all, *weil*-V2-adverbial are restricted to a final position, which means that they neither stand in front of their matrix clause nor within it, cf. (27). This is clearly in contrast to *weil*-VL-adverbial clauses, cf. (28).

- (27) a. Peter kommt zu spät, weil er hat keinen Parkplatz  
*Peter comes too late because he has no parking space*  
 gefunden.  
*found*  
 'Peter is late because he could not find a parking space.'
- b. \*Weil er hat keinen Parkplatz gefunden, kommt Peter zu  
*Because he has no parking space found comes Peter too*  
 spät.  
*late*

<sup>7</sup>There are adverbial clauses introduced by *obwohl* ('although'), such as *Maria verehrt ihren Mann, obwohl verdient hat er es nicht*. ('Maria admires her husband, although he doesn't deserve it.')

<sup>8</sup>*Weil*-V2-adverbial clauses are mainly attested for colloquial German, but can be observed in written German as well, cf. Wegener (1993), Uhmann (1998).

- c. \* Peter kommt, weil er hat keinen Parkplatz gefunden, zu spät.  
*Peter comes because he has no parking space found too late*
- (28) a. Peter kommt zu spät, weil er keinen Parkplatz gefunden hat.  
*Peter comes too late because he has no parking space found*  
 ‘Peter is late because he could not find a parking space.’
- b. Weil er keinen Parkplatz gefunden hat, kommt Peter zu spät.  
*Because he no parking space found has comes Peter too late*  
 ‘Because he could not find a parking space, Peter is late.’
- c. Peter kommt, weil er keinen Parkplatz gefunden hat, zu spät.  
*Peter comes because he no parking space found has too late*  
 ‘Peter, because he could not find a parking space, is late.’

Additionally, *weil*-V2-adverbial clauses cannot be transferred into an adverbial phrase being a component part of the matrix clause, which one would expect if they were subordinate. Further, it is impossible to refer to them by a correlative or to attach them by an *und zwar*-supplement as can be seen in (29).

- (29) a. Peter kommt (\*deswegen) zu spät, weil er hat keinen Parkplatz gefunden.  
*Peter comes too late because he has no parking space found*  
 ‘Peter is late because he could not find a parking space.’
- b. \* Peter kommt zu spät, und zwar weil er hat keinen Parkplatz gefunden.  
*Peter comes too late namely he has no parking space found*

Example (30a) demonstrates that a *weil*-V2-adverbial clause is illocutionary independent from its host clause, since it expresses a statement being not part of the question raised by the host. This argues for the root character of these clauses, and contrasts with canonical causal clauses as shown in (30b).

- (30) a. Kommt Peter? Weil er hat es versprochen.  
*Comes Peter because he has it promised*  
 ‘Is Peter coming? Because he promised to.’
- b. Kommt Peter, weil er es versprochen hat?  
*Comes Peter because he it promised has*  
 ‘Is Peter coming because he promised to?’

Certain prosodical facts also suggest that *weil*-V2-adverbial clauses behave like root clauses. So, the intonational unit of a *weil*-V2-adverbial clause is separated from the one of the host clause, and the host clause ends with falling intonation.



Evidence for the root-like status of *weil*-V2-adverbial clauses eventually comes from negation and quantifier binding. A *weil*-V2-adverbial clause is not tangent to a negation of the host clause, i.e. the content of the *weil*-V2-adverbial clause is not negated if the host clause contains a negative particle, cf. (31a). Whereas it is denied in (31b) that Peter went home because of a head ache, (31a) means that Peter did not drive home.

- (31) a. Peter ist nicht nach Hause gefahren, weil er hatte Kopfweh.  
*Peter is not home driven because he had a head ache*  
 ‘Peter did not drive home because he had a head ache.’
- b. \* Peter ist nicht nach Hause gefahren, weil er Kopfweh hatte.  
*Peter is not home driven because he a head ache had*

Moreover, a quantifier in the host clause does not scope over the *weil*-V2-adverbial clause, cf. (32). In comparison to (32b), (32a) justifies why the speaker believes that some guests will come, while (32b) means that some guests will come because of the sunny weather.

- (32) a. Einige Gäste werden kommen, weil heute scheint die Sonne.  
*Some guests will come because today shines the sun*  
 ‘Some guests will come, because today the sun is shining.’
- b. Einige Gäste werden kommen, weil heute die Sonne scheint.  
*Some guests will come because today the sun shines*  
 ‘Some guests will come, because the sun is shining today.’

Finally, the pragmatic interpretation of *weil*-V2-adverbial clauses is peculiar. They behave differently from canonical *weil*-clauses in that they are able to give reasons for a speaker’s attitude.<sup>9</sup>

## 2.6 *Wh*-relative clauses

*Wh*-relative clauses are a subclass of non-restrictive relative clauses that are introduced by a possibly complex *wh*-expression as exemplified by (33).

- (33) Max spielt Orgel, was gut klingt.  
*Max plays organ which good sounds*  
 ‘Max is playing the organ, which sounds good.’

As has been shown in Holler (2003) and Holler (2005), *wh*-relatives are prosodically and pragmatically independent from their matrix clause, which is indicated *inter alia* by an independent focus domain, cf. (34), and an autonomous illocutionary force, cf. (35). The construction in (34) for instance cannot be uttered as an answer to the question *What happened?*, which indicates that the *was*-clause is not integrated into the information structure of the host. Similarly, (35) is ungrammatical, because the *was*-clause has been forced to be a part of the host’s speech act which is a question.

<sup>9</sup>See Haegeman (1984) for a discussion of similar phenomena in English.

- (34) #[Emma kaufte einen teuren Schrank, was Ärgerlich ist.]<sub>F</sub>  
*Emma bought an expensive cupboard which annoying is*  
 ‘Emma bought an expensive cupboard, which is annoying.’
- (35) \* Hat Emma einen Schrank gekauft, was Oskar erstaunte?  
*has Emma a cupboard bought which Oskar astonished*

Moreover, *wh*-relatives behave like typical root clauses as they are syntactically dispensable, cf. (36), disallow variable binding from outside, cf. (37), and occur only at the very end of a complex sentence, cf. (38), which illustrate that a *wh*-relative follows an extraposed complement clause or relative clause.

- (36) a. Max spielt Orgel, was gut klingt.  
*Max plays organ which good sounds*  
 ‘Max is playing the organ, which sounds good.’
- b. Max spielt Orgel.  
*Max plays organ.*  
 ‘Max is playing the organ.’
- (37) \* Niemand<sub>i</sub> gewann das Schachspiel, was ihn<sub>i</sub> maßlos ärgerte.  
*nobody won the game of chess which him extremely annoyed*
- (38) a. Es fiel Maria nicht auf, dass sie sich verrechnet hatte,  
 EXPL *realized Maria not PART that she REFL mistaken had*  
 weswegen sie sich jetzt ärgert.  
*that’s why she REFL now annoyed*  
 ‘Maria didn’t realize that she made a mistake, and that’s why she is annoyed now.’
- b. \* Es fiel Maria nicht auf, weswegen sie sich jetzt ärgerte,  
 EXPL *realized Maria not PART that’s why she REFL now annoyed*  
 dass sie sich verrechnet hatte.  
*that she REFL mistaken had*

Semantically, *wh*-relatives contrast with restrictive relative clauses which are usually analyzed as denoting properties since they are introduced by an anaphoric pronoun and denote propositions. This is certainly a consequence of the non-restrictiveness of the *wh*-relatives. Furthermore, they behave similar to the clauses discussed above in terms of negation since a negative particle in the matrix host does not scope over *wh*-relatives.

Taking all the presented syntactic, semantic and pragmatic properties into account, one has to conclude that *wh*-relatives are not integrated into their host clause.

## 2.7 Summary of the Data

Looking at the data given so far reveals that three classes of dependent clauses can be distinguished depending on the way of being linked to their linguistic sur-

rounding. Besides the canonical dependent clauses including all clauses that form directly or indirectly a component part of their matrix clause (such as complement clauses of all kinds, ordinary adverbial clauses, restrictive relative clauses, etc.), two classes of dependent, but non-canonically linked clauses can be identified by means of the grammatical properties afore described. Table 1 gives an overall picture of these facts. It strikes that the position of the finite verb is not appropriate to differentiate between these clausal classes. Rather, the data suggest that clauses differ in the degree to which they are integrated into a potential matrix clause. This is in accordance to the results of Fabricius-Hansen (1992) who shows that the linkage of subordinate clauses to their hosts is graded.

<b>Clausal Class</b>	<b>Integrated</b>	<b>Semi-integrated</b>	<b>Non-integrated</b>
Prosodically integrated	yes	yes	no
Syntactically connected	yes	yes	no
Semantically peculiar	no	yes	yes
Indep. information structure	no	no	yes
Indep. illocutionary force	no	yes	yes
Typical example	a (VF)	d (V2)	g (VF)
	b (VF)	e (V2)	h (VF)
	c (VF/V2)	f (VF)	i (V2)

Table 1: Grammatical properties of three empirically identified classes of dependent clauses. For reasons of space, the following abbreviations are used: a = complement clause, b = restrictive relative clause, c = standard adverbial clause, d = dependent V2-clause, e = restrictive V2-relative clause, f = free *dass*-clause, g = non-restrictive *d*-relative clause, h = non-restrictive *wh*-relative clause, i = *weil*-V2-adverbial clause.

### 3 Accounting for the Facts

The sign-based monostratal architecture of HPSG qualifies very well to account for the presented data. The core of the analysis advocated here is the observation that clauses vary with respect to the way they are linked to their linguistic surrounding. Because this originates from syntactic, semantic and pragmatic properties of the clauses involved, it seems to be natural to encode it in grammar.

In HPSG, the sort hierarchy lends itself to reconstruct the observed distinction. For this reason, it is proposed to partition the sort *phrase* regarding a dimension LINKAGE, and to distinguish between *unlinked* and *linked* objects. The sort *unlinked* comprises all independently uttered sentences including independent verb-final clauses as given by (2b). The sort *linked* describes all objects that are somehow combined with their linguistic surrounding, which applies to all clausal types depicted in table 1. According to the empirical results summarized by table

1, the sort *linked* is further partitioned by three subsorts called *integrated*, *semi-integrated* and *non-integrated* representing clausal objects that are fully, partly or not integrated into a potential matrix clause.<sup>10</sup> It is assumed that the newly defined sorts are cross-classified with subsorts of *headed-phrase* which is an immediate subsort of *phrase* with respect to the dimension HEADEDNESS, cf. Sag (1997).

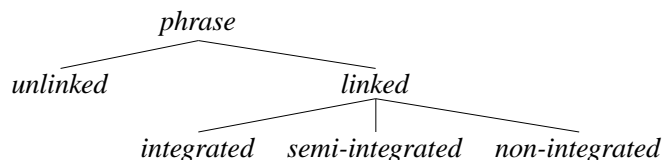

Figure 2: Partition of *phrase* w.r.t. the dimension LINKAGE

Nothing in particular shall be said here about clauses of sort *integrated*, since they are analyzed in a standard way. The two remaining clausal classes of sort *linked*, i.e. *semi-integrated* and *non-integrated* clauses, are certainly more instructive. Next, an analysis will be sketched which formulates restrictions on these two sorts and, thus, captures the syntactic, semantic and pragmatic properties of the clause types discussed in sec. 2.

### 3.1 Clauses of sort *semi-integrated*

It has been argued that clauses of sort *semi-integrated* are less tightly connected to their matrix clause as they have the properties (iii) to (v) presented in sec. 2. On the other hand, these clauses are obviously syntactically connected with their host because of the properties (i) and (ii), which they also show. In order to cope with this behavior, clauses of sort *semi-integrated* are analyzed as modifiers of a saturated verbal projection, which particularly means that they are no complement clauses since they do not saturate an argument of the matrix predicate.

Further, an approach by Engdahl and Vallduví (1996) is adopted who stipulate an INFO-STRUCTURE attribute enriching CONTEXT to represent the focus-background structure of a clause. It is assumed here that *semi-integrated* clauses identify their INFO-STRUCTURE value with that of the matrix clause, thereby accounting for property (i).

In addition, a suggestion by Green (2000a) is acted on to deal with the fact that semi-integrated clauses are not a part of the speech act of their host, but have illocutionary force of their own.<sup>11</sup> Green (2000a) defines an *psoa* object of sort *intend*, which is contained in the BACKGROUND set of a phrase. By requiring that

<sup>10</sup>Unfortunately, it cannot be discussed here to which extent this distinction can be used for constituents other than clauses. At least, there is evidence from German and English that nominal left-peripheral elements also need to be classified regarding their degree of (non-)integratedness into a clause, cf. Shaer and Frey (2004).

<sup>11</sup>Of course, any other analysis of illocutionary force could have been implemented here.

the *intend*-object of the matrix clause, which is the head of the phrase representing the construction, differs from the one of the modifying semi-integrated clause the desired result is achieved. The constraint on objects of sort *semi-integrated* shown in fig. 3 expresses the afore mentioned restrictions.

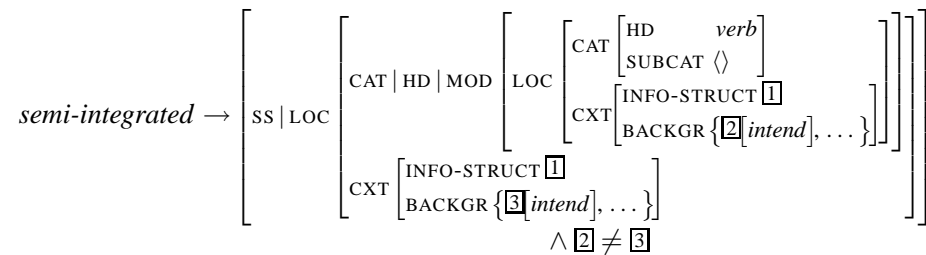

Figure 3: Restricting *semi-integrated* clauses

Fig. 4 gives an example analysis for the construction *Maria glaubt, Studenten schlafen lange*. (‘Maria believes that students sleep long’), which contains a dependent V2-clause. This clause syntactically modifies its matrix clause expressed by tag 1. Tag 2 marks the information structure which comprises the whole construction. Tag 3 and 4 represent the illocutionary force of each constituent.

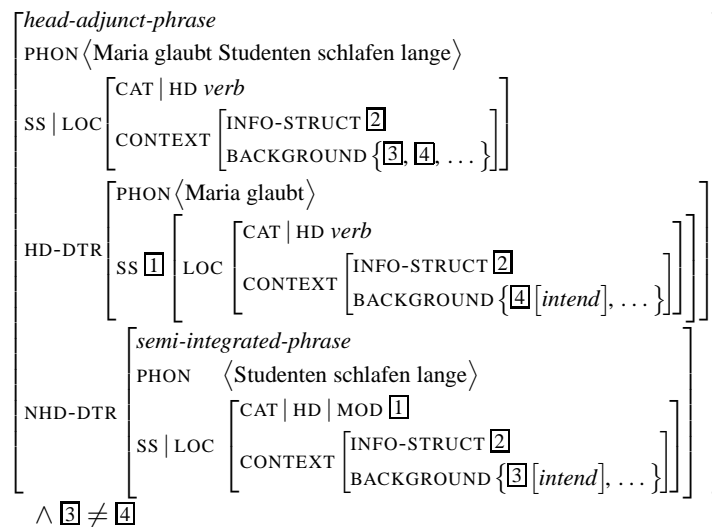

Figure 4: Example feature structure for constructions containing a semi-integrated clause

### 3.2 Clauses of sort *non-integrated*

To account for clauses of sort *non-integrated*, an approach to peripheral adverbials by Haegeman (1991) is adapted. Clauses of sort *non-integrated* are analyzed as

orphan constituents, which means that they are syntactically unattached.<sup>12</sup> Following Haegeman (1991), orphaned clauses serve to form the discourse frame against which the proposition expressed in the matrix clause is evaluated by providing additional background information. Hence, the modification relation is not established in syntax, but rather at the level of utterance interpretation. This can easily be implemented into an HPSG-based grammar by introducing phrases of sort *head-orphan-phrase* as subsort of *headed-phrase*, cf. fig. 5, and requiring that the CONTENT value of an orphan is unified with the BACKGROUND set of its head, while the MOD attribute is specified as *none*, cf. fig. 6.

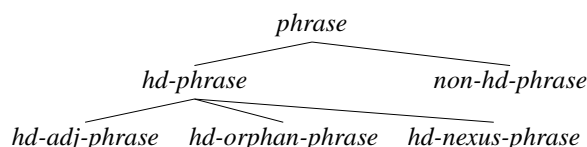

Figure 5: Partition of *phrase* w.r.t. HEADEDNESS

As depicted in fig. 6, the fact that an orphan is not included into the host’s information structure is again grasped by restricting the value of the INFO-STRUCTURE attribute as it is stipulated that the INFO-STRUCTURE value of the orphan does not equal the INFO-STRUCTURE value of its host. Since an orphan also has illocutionary force of its own the BACKGROUND value of the head-daughter of phrases of sort *head-orphan-phrase* has to be different from the one of the non-head daughter, which represents the orphan.

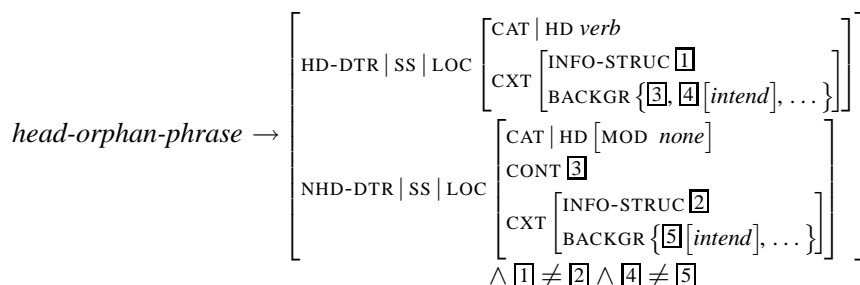

Figure 6: Restricting orphan constituents such as *non-integrated* clauses

Since *non-integrated* clauses are cross-classified as a subsort of *head-orphan-phrase*, they have to obey the restrictions for orphans. This analysis provides a vanilla account of the properties of *non-integrated* clauses as described in sec. 2.<sup>13</sup>

Fig. 7 gives an example feature structure for the sentence *Peter kommt zu spät, weil er hat keinen Parkplatz gefunden*. (‘Peter is late because he could not find a

<sup>12</sup>However, this does not mean that orphans are syntactically unconstrained, see Haegeman (1991).

<sup>13</sup>The fact that negation neither takes scope over *semi-integrated* clauses nor *non-integrated* ones can easily be implemented in the lexicon by restricting negation particles and negative verbs to clauses of sort *integrated*. Further, LP rules may be defined which limit clauses of sorts *semi-integrated* and *non-integrated* to final positions in a complex sentence structure.

parking space.’) The adverbial clause is marked as being of sort *non-integrated-phrase*. It does not syntactically modify its host since the value of its MOD attribute is instantiated as *none*. However, the CONTENT value of the orphan is inserted into the BACKGROUND set of the head, which is expressed by tag 3. Tag 1 and 2 mark the information structure of each constituent and tag 5 and 6 the illocutionary force.<sup>14</sup>

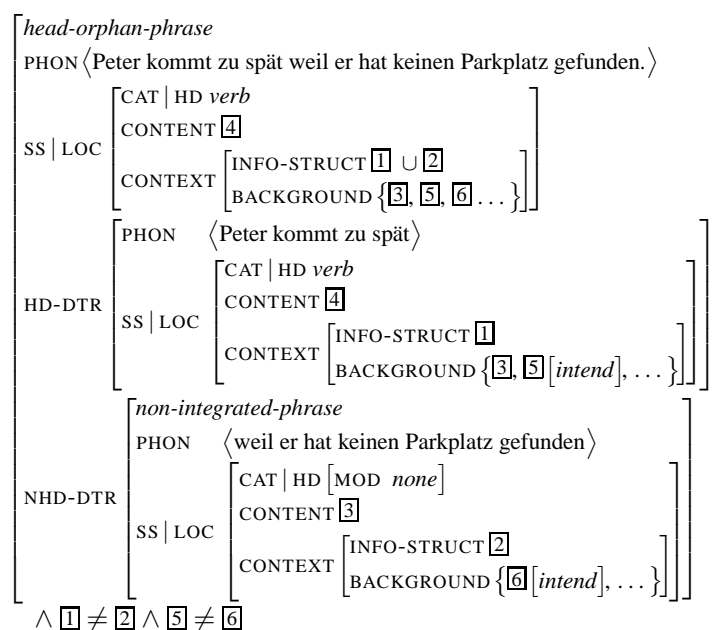

Figure 7: Example feature structure for constructions containing a non-integrated clause

The presented approach to non-integrated clauses has the advantage that the discourse-structural relation between these clauses and their hosts can be expressed without being forced to establish a syntactic relation as well.

## 4 Conclusion

Considering as example German, the present paper has investigated non-canonical clause linkage phenomena and has developed a constraint-based analysis accounting for the empirical fact that clauses need to be distinguished regarding their degree of integratedness into a potential matrix clause. It has been shown that the generally assumed twofold distinction between main and subordinate clauses (or root and embedded clauses) does not suffice to deal with the presented data. Moreover, it has been argued that the discussed linkage phenomena originate from syntactic,

<sup>14</sup>Tag 4 marks the semantic content of the whole construction which is projected from the head.

semantic and pragmatic properties of the clauses involved, and should hence be encoded in grammar. By partitioning objects of sort *phrase* in terms of a LINKAGE dimension and by constraining the CONTEXT value of these objects, the data are covered without any reference to a position of the finite verb. Additionally, non-integrated clauses are considered as ‘orphan’ constituents which are unattached in syntax, but provide the context for the interpretation of their host clause. Such an approach explains the empirical facts assembled in a straightforward way. Further research may show to what extent the proposed analysis can cope with similar phenomena in other languages.

## References

- Boettcher, Wolfgang. 1972. *Studien zum zusammengesetzten Satz*. Frankfurt/M.: Athenäum.
- Drach, Erich. 1937. *Grundgedanken der deutschen Satzlehre*. Frankfurt: Diesterweg.
- Emonds, Joseph. 1970. *Root and Structure-Preserving Transformations*. Ph. D.thesis, MIT, Cambridge.
- Engdahl, Elisabeth and Vallduví, Enric. 1996. Information Packaging in HPSG. In Claire Grover and Enric Vallduví (eds.), *Edinburgh Working Papers in Cognitive Science, Vol. 12: Studies in HPSG*, Chapter 1, pages 1–32, Scotland: Centre for Cognitive Science, University of Edinburgh.
- Fabricius-Hansen, Catherine. 1992. Subordination. In Ludger Hoffmann (ed.), *Deutsche Syntax. Ansichten und Aussichten*, Jahrbuch des IDS 1991, pages 458–483, Berlin, New York: Walther de Gruyter.
- Green, Georgia. 1996. Distinguishing main and subordinate clause: The root of the problem, unpl. Ms., Univ. of Illinois.
- Green, Georgia. 2000a. The Nature of Pragmatic Information. In Ronnie Cann, Claire Grover and Philip Miller (eds.), *Grammatical Interfaces in HPSG*, Studies in Constraint-Based Lexicalism, No. 8, pages 113–138, Stanford: CSLI Publications.
- Green, Mitchell. 2000b. Illocutionary Force and Semantic Content. *Linguistics and Philosophy* 23, 435–473.
- Gärtner, Hans-Martin. 2001. Are there V2-Relative Clauses in German? *Journal of Comparative Germanic Linguistics* 3(2), 97–141.
- Haegeman, Liliane. 1984. Remarks on Adverbial Clauses And Definite NP-Anaphora. *Linguistic Inquiry* 15, 712–715.
- Haegeman, Liliane. 1991. Parenthetical Adverbials: The Radical Orphanage Approach. In Shuji Chiba, Akira Ogawa, Yasuaki Fuiwara, Norio Yamada, Osamu Koma and Takao Yagi (eds.), *Aspects of Modern English Linguistics*, pages 232–254, Tokyo: Kaitakusha.
- Holler, Anke. 2003. An HPSG Analysis of the Non-Integrated Wh-Relative Clauses in German. In Stefan Müller (ed.), *Proc. of the HPSG-2003 Conf.*,



- Michigan State University, East Lansing, pages 163–180, Stanford: CSLI Publications.
- Holler, Anke. 2005. *Weiterführende Relativsätze. Empirische und theoretische Aspekte*, volume 60 of *studia grammatica*. Berlin: Akademie Verlag.
- Hooper, John and Thompson, Sandra. 1973. On the applicability of root transformations. *Linguistic Inquiry* 4, 465–497.
- Kathol, Andreas. 1995. *Linearization-Based German Syntax*. Ph.D.thesis, Ohio State University.
- Meinunger, Andre. 2004. Verb position, verbal mood and the anchoring (potential) of sentences. In Horst Lohenstein and Susanne Trissler (eds.), *The syntax and semantics of the left periphery*, pages 313–341, Mouton de Gruyter.
- Netter, Klaus. 1998. *Functional Categories in an HPSG for German*. Saarbrücken Dissertations in Computational Linguistics and Language Technology, No. 3, Saarbrücken: German Research Center for Artificial Intelligence (DFKI) and University of the Saarland.
- Reape, Mike. 1994. Domain Union and Word Order Variation in German. In John Nerbonne, Klaus Netter and Carl J. Pollard (eds.), *German in Head-Driven Phrase Structure Grammar*, pages 151–197, Stanford University: CSLI Publications.
- Reis, Marga. 1995. Extractions from Verb-Second Clauses in German? In Uli Lutz and Jürgen Pafel (eds.), *On Extraction and Extraposition in German*, pages 45–88, Amsterdam: John Benjamins Publ. Company.
- Reis, Marga. 1997. Zum syntaktischen Status unselbständiger Verbzweit-Sätze. In Christa Dürscheid, Karl Heinz Ramers and Monika Schwarz (eds.), *Syntax im Fokus. Festschrift für Heinz Vater.*, Tübingen: Niemeyer.
- Reis, Marga. 1999. On Sentence Types in German: An Enquiry in the Relationship between Grammar and Pragmatics. *Interdisciplinary Journal for Germanic Linguistics and Semiotic Analysis* 4(2), 195–236.
- Sag, Ivan A. 1997. English Relative Clause Constructions. *Journal of Linguistics* 33(2), 431–484.
- Shaer, Benjamin and Frey, Werner. 2004. Integrated and Non-Integrated Leftperipheral Elements in German and English. In Benjamin Shaer, Werner Frey and Claudia Maienborn (eds.), *Proceedings of the Dislocated Elements Workshop, ZAS Berlin 2003*, volume 2 of *ZAS Papers in Linguistics* 35, pages 465–502.
- Steinbach, Markus. 1999. Notes on parenthetical constructions. Arbeitspapiere des SFB 340 144, Univ. of Tübingen.
- Uhmann, Susanne. 1998. Verbstellungsvariation in weil-Sätzen. *Zeitschrift für Sprachwissenschaft* 17(1), 92–139.
- Uszkoreit, Hans. 1987. *Word Order and Constituent Structure in German*. Chicago University Press.
- Wegener, Heide. 1993. Weil – das hat schon seinen Grund. Zur Verbstellung in Kausalsätzen mit weil im gegenwärtigen Deutsch. *Deutsche Sprache* pages 289–305.

# The syntax and semantics of multiple degree modification in English

Christopher Kennedy 

University of Chicago

Louise McNally 

Universitat Pompeu Fabra

Proceedings of the 12th International Conference on  
Head-Driven Phrase Structure Grammar

Department of Informatics, University of Lisbon

Stefan Müller (Editor)

2005

Stanford, CA: CSLI Publications

pages 178–191

Kennedy, Christopher & Louise McNally. 2005. The syntax and semantics of multiple degree modification in English. In Stefan Müller (ed.), *Proceedings of the 12th International Conference on Head-Driven Phrase Structure Grammar, Department of Informatics, University of Lisbon*, 178–191. Stanford, CA: CSLI Publications. DOI: 10.21248/hpsg.2005.10. 

## Abstract

Focusing on the examples of multiple degree modification, this paper argues that the class of degree expressions in English is syntactically and semantically diverse, subdivided both according to the semantic effects of its members and according to the extent to which they permit, and participate in, multiple layers of modification. We argue that these two factors are linked, and result in (at least) a three-way distinction between TRUE DEGREE MORPHEMES, which map gradable adjectives to properties of individuals and combine with their arguments in a Head-Specifier structure; INTENSIFIERS, which are syntactic and semantic modifiers of properties constructed out of gradable adjectives; and SCALE MODIFIERS, which are also syntactic and semantic modifiers, but which combine with ‘bare’ gradable adjectives (relations between individuals and degrees) rather than properties formed out of gradable adjectives.

## 1 Introduction

In this paper we offer an integrated syntactic and semantic analysis of various cases of multiple degree modification in English, some examples of which appear in (1).

- (1) a. a new tower 10 feet taller than the Empire State Building
- b. an old department store a lot less taller than the city hall building than is the new company headquarters
- c. an engineer very much more afraid of heights than the architect

To our knowledge, no such integrated proposal exists for this kind of modification in the HPSG literature. Pollard and Sag (1994) broadly sketch a syntactic analysis of multiple degree modification, but because it lacks a semantics, their analysis does not make specific predictions about the restrictions on various combinations of multiple degree modifiers. Although some of these restrictions are matters of pragmatic or lexical semantic detail, others involve fundamental aspects of the syntax and semantics of degree modification. In contrast, Abeillé and Godard (2003) present a detailed syntax and semantics for French degree adverbs, but their analysis is situated in the context of a general analysis of adverbial modification, rather than in the context of a complete treatment of degree modification. As a result, their analysis does not address multiple degree modification or differences in the distributions of different subclasses of degree expressions (On the other hand, nothing in our analysis will conflict in important ways with their proposal.)

In this paper, we present a syntax and semantics of degree modifiers that includes elements of both Pollard and Sag’s specifier analysis and Abeille and Godard’s modifier analysis. Specifically, we argue for a subdivision of the set of degree modifiers into three subclasses, which differ both in their syntax and their

---

<sup>†</sup>We are grateful to the HPSG05 audience for comments. All errors are our own. This research reported here is based on work supported by the National Science Foundation under Grant No. 0094263 and by a grant from the Generalitat de Catalunya.

semantic types/functions. The class of TRUE DEGREE MORPHEMES (measure phrases, degree *that*, etc) combine with a gradable adjective in a head-specifier structure, and map the adjective (type  $\langle d, \langle e, t \rangle \rangle$  — a relation between individuals and degrees) to a property of individuals (type  $\langle e, t \rangle$ ). The class of INTENSIFIERS (*very*, *rather*, etc.) are predicate modifiers of a familiar sort (type  $\langle \langle e, t \rangle, \langle e, t \rangle \rangle$ ) that are semantically restricted to combine just with properties of individuals based on gradable adjectives. Finally, the class of SCALE ADJUSTERS (comparative morphology) are modifiers of gradable adjectives (type  $\langle \langle d, \langle e, t \rangle \rangle, \langle d, \langle e, t \rangle \rangle \rangle$ ), which ‘readjust’ the scale onto which an adjective maps its argument.

The paper is organized as follows. In section 2, we lay out our basic assumptions about the semantics of gradable adjectives, and the problems presented by cases of multiple degree modification. In section 3 we make the case for splitting the set of degree terms into three classes, outline our analysis of each class, and relate our proposals to previous work. We conclude in section 4 with a more general discussion of the implications of our proposals.

## 2 Gradable adjectives and degree expressions

As the syntax of multiple degree modification is tightly bound up with the semantics of the expressions involved, we begin by presenting our semantic assumptions. We will essentially follow Kennedy and McNally (2005) (and many others) in analyzing gradable adjectives and related expressions (such as the vague determiners *many* and *few*) as relations between degrees and individuals (type  $\langle d, \langle e, t \rangle \rangle$ ). Such expressions are converted to properties of individuals by degree expressions, which include measure phrases (e.g. *10 feet*), comparative morphemes (e.g. *-er/more*, *less*, *as*), intensifiers (e.g. *very*), and the phonologically null positive degree morpheme *pos* (for the ‘positive’, unmarked form of a gradable adjective, e.g., *(is) tall*). In Kennedy and McNally’s analysis, degree expressions convert a gradable adjective into a property of individuals by binding the degree argument of the adjective and restricting it to satisfy certain conditions, e.g. the property of measuring some amount in the case of a measure phrase, or the property of exceeding some other degree in the case of comparatives with *more*.

For example, the comparative constituent *more than*  $d_c$  (where  $d_c$  is the denotation of the comparative clause, a maximal degree; see von Stechow (1984)) has the denotation in (2).

$$(2) \quad \llbracket \text{more than } d_c \rrbracket = \lambda g \in D_{\langle d, \langle e, t \rangle \rangle} \lambda x. \exists d [d \succ d_c \wedge g(d)(x)]$$

A simple comparative predicate like (3a) is assigned the denotation in (3b): it is true of an object if it has a degree of height that exceeds the maximal degree to which the Empire State Building is tall, here abbreviated as  $d_{esb}$ .<sup>1</sup>

<sup>1</sup>We assume for simplicity here that the comparative clause is an ellipsis structure; this issue is orthogonal to the main concerns of this paper. See Kennedy (2002) for a compositional analysis. Likewise, we abstract away from the morphological alternation between *more* and *-er*.

- (3) a. [tall [er then the Empire State Building ~~is tall~~]]  
 b.  $\lambda x. \exists d [d \succ d_{esb} \wedge \mathbf{tall}(d)(x)]$

A problem with this approach is that multiple degree modification facts such as those illustrated in (1) and other data strongly suggest that neither comparative morphemes nor intensifiers really belong in the category of degree morphology as defined above. For example, (1b) shows that a comparative can modify another comparative, which is unexpected on this analysis, since degree expressions as a class are treated as type-changing. Kennedy and McNally (2005) would be forced to hypothesize that e.g. *less* can combine not only with expressions of type  $\langle d, \langle e, t \rangle \rangle$  (when it cooccurs with a simple adjective) but also with property-denoting ones (when it combines with a comparative+adjective complex). This is not a typical case of type polymorphism.

Similar comments apply to intensifiers. Although it is sometimes claimed to the contrary, a number of combinations of multiple intensifiers are possible (as even a simple Google search will demonstrate):

- (4) a. He specializes in swimwear and is quite very popular for it.  
 ([www.thefashionspot.com/forums/archive/index.php/t-907.html](http://www.thefashionspot.com/forums/archive/index.php/t-907.html))  
 b. *Lola Rennt*, or *Run, Lola, Run* in English, is the first German film I've ever seen. It's rather very inventive.  
 ([www.rottentomatoes.com/vine](http://www.rottentomatoes.com/vine))  
 c. He also writes...Comedy Variety shows such as...“The Lorne Elliott’s Really Rather Quite Half-Decent TV Special” for CBC-TV.  
 ([lorne-elliott.com/about.htm](http://lorne-elliott.com/about.htm))

Again, Kennedy and McNally’s treatment of intensifiers as type changing forces one to adopt a rather ad hoc type polymorphism to account for the fact that these expressions modify both adjectives and other intensifiers. They can furthermore modify comparative morphology, but not the other way around. This is illustrated by the examples in (5). (Here we follow Corver (1997) in treating *much* in (5) and (7) below as a dummy element.)

- (5) a. This new building will give the University very much more effective support for teaching and research in the Social Sciences.  
 (<http://www.bodley.ox.ac.uk/librarian/rhodes/rhodes.htm>)  
 b. ...to establish why the Jullunduris have pressed their way upwards through the employment market, the housing market, and the educational system very much more rapidly than either the Mirpuris or the Sylhetis.  
 (<http://www.transcomm.ox.ac.uk/wwwroot/ballard.htm>)  
 c. In principle it is fairly simple and gives distributions very close to analytically calculated distributions with very much less computation time. ([http://www.rlaha.ox.ac.uk/oxcal/math\\_gi.htm](http://www.rlaha.ox.ac.uk/oxcal/math_gi.htm))

- (6) a. This new building will give the University (\*more) very effective support. (\*[[more [very A]] N];  $\sqrt{[more [[very A] N]]}$ )  
 b. They moved (\*more) very rapidly than the others.  
 c. There was (\*less) very much computation time.

In contrast to the comparative morphemes and intensifiers stand a group of degree expressions that ‘close off’ the predicate they combine with, disallowing any amount of further modification (of any kind). These include (at least) measure phrases, degree *this/that*, proportional modifiers like *completely* and *half*, and the *wh*-degree morpheme *how*. These expressions can combine with an unmodified adjective or with a comparative (provided a system of measurement is defined for the adjective in the case of measure phrases), as shown in (7) for the measure phrase *2 meters* and degree *that*.

- (7) a. 2 meters/that tall  
 b. 2 meters/that much {taller, less tall, too tall}

However, they do not accept further modification (8a), nor can they further modify an intensifier (8b) (we assume the *much* in (7b) is a dummy element; see Corver (1997)):

- (8) a. \*rather 2 meters/that long  
 b. \*2 meters/that (much) very long

These observations lead us to the three way classification described at the beginning of the paper, which we will develop in detail in the next section.

### 3 Three classes of degree expressions and one lexical rule

#### 3.1 The positive form

Kennedy and McNally (2005) assume that the positive form involves a null degree morpheme *pos*, which maps a gradable adjective to a property of individuals that expresses a relation to a context-dependent standard of comparison (see also Bartsch and Vennemann (1972), Cresswell (1977), Klein (1980), von Stechow (1984), Kennedy (1999)). The positive form of an adjective like *tall* is thus analyzed as the predicate [<sub>AP</sub> *pos* tall], which denotes the property of having a degree of length that exceeds a standard of length whose value is determined based on features of the context of utterance (what is being talked about, the interests/expectations of the participants in the discourse, etc.; see Lewis (1970), Bogusławski (1975), Graff (2000), Barker (2002), Kennedy (2005)).

In this paper, we take the (possibly universal) absence of overt morphology in the positive form at face value and instead posit a lexical rule that maps measure functions to properties of individuals in the absence of overt degree morphology. This rule (whose particular implementation is not crucial for our purposes) is stated

in (9), where **stnd** is a context-dependent function from a measure function (a ‘basic’ gradable adjective meaning) to a degree in the range of the measure function (its scale) that represents an appropriate standard of comparison for the gradable property measured by the adjective in the context of utterance. (Compare Lewis’ (1970) and Barker’s (2002) DELINEATION FUNCTION.)

$$(9) \left[ \begin{array}{l} g \\ \text{syn} \left[ \begin{array}{l} \text{head} \quad \boxed{4} \text{adj} \\ \text{val} \quad \left[ \text{spec} \langle \text{deg} \rangle \right] \end{array} \right] \\ \text{sem} \left[ \begin{array}{l} \text{index} \quad \boxed{2} \\ \text{restr} \quad \left\langle \boxed{5} \left[ \begin{array}{l} \text{reln} \quad \boxed{1} \mathbf{g} \\ \text{arg1} \quad \boxed{2} x \\ \text{arg2} \quad \boxed{3} d \end{array} \right] \right\rangle \end{array} \right] \end{array} \right] \mapsto \left[ \begin{array}{l} g \\ \text{syn} \left[ \begin{array}{l} \text{head} \quad \boxed{4} \\ \text{val} \quad \left[ \text{spec} \langle \rangle \right] \end{array} \right] \\ \text{sem} \left[ \begin{array}{l} \text{index} \quad \boxed{2} \\ \text{restr} \quad \left\langle \boxed{5}, \left[ \begin{array}{l} \text{reln} \quad \mathbf{stnd} \\ \text{arg1} \quad \boxed{3} \end{array} \right] \right\rangle \end{array} \right] \end{array} \right]$$

With this as our starting point, we now turn to the analysis of degree morphology.

### 3.2 True degree morphemes

The class of true degree morphemes includes measure phrases, proportional modifiers, *that* and *how*; these are degree expressions that behave as assumed in Kennedy and McNally (2005). Syntactically, they combine in a Head-Specifier structure; semantically, they map a gradable adjective onto a property of individuals by restricting the degree argument of the adjective based on the content of the degree expression. The intuition underlying this analysis is that ‘true’ degree morphemes all directly supply a value for the degree argument of the adjective, fixing the standard degree that serves as the criterion for truthful ascription of a gradable predicate.

We illustrate our proposal with an analysis of the measure phrase *2 meters* in (10), and the predicate *2 meters tall* in (11), in which the restriction on the degree argument is based on the measurement expressed by the nominal.

$$(10) \left[ \begin{array}{l} 2 \text{ meters} \\ \text{syn} \quad \left[ \text{head} \quad \text{deg} \right] \\ \text{sem} \quad \left[ \text{restr} \quad \left\langle \left[ \begin{array}{l} \text{reln} \quad \mathbf{2 \text{ meters}} \\ \text{arg1} \quad d \end{array} \right] \right\rangle \right] \end{array} \right]$$

(11)

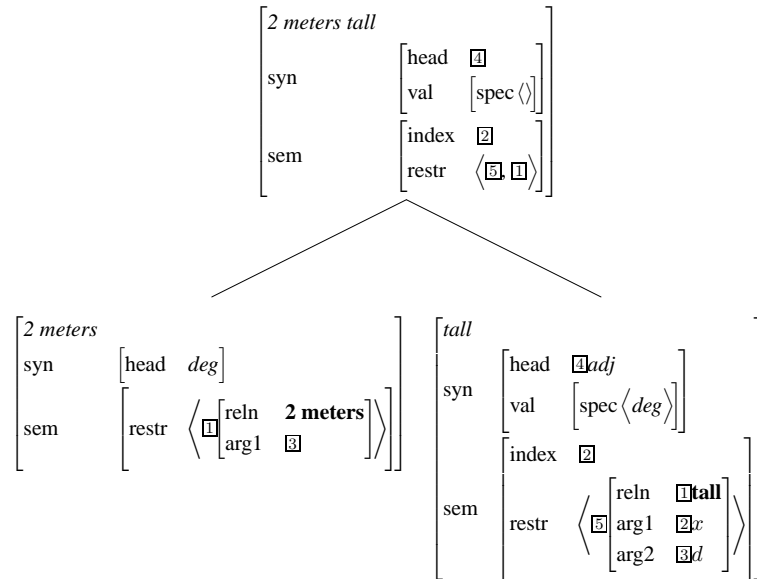

### 3.3 Intensifiers

Recall that intensifiers like *very* are special in that they can modify (apparently bare) adjectives as well as intensifier+adjective combinations and comparatives, but not true degree morpheme+adjective combinations, and they cannot themselves be modified by anything other than other intensifiers. We derive this distribution by analyzing intensifiers as traditional predicate modifiers (type  $\langle\langle e, t \rangle, \langle e, t \rangle\rangle$ ) that are restricted to apply only to predicates whose meaning is stated in terms of the **stnd** function — i.e., gradable predicates in the positive form.

The latter restriction sounds like a stipulation, but we claim that in fact it follows from their semantics. Specifically, building on proposals in Wheeler (1972); Klein (1980) and Kennedy and McNally (2005), we claim that the semantic function of an intensifier is to manipulate the **stnd** function introduced by the positive form rule in (9). This proposal is based on two observations. First, the semantic effect of intensification is to ‘adjust’ the contextually determined standard of comparison. Second, the distribution of degree modifiers is highly sensitive to the type of standard of comparison associated with particular *pos*+adjective combinations (whether the standard is context dependent or lexically determined by the adjectival head; see Kennedy and McNally’s (2005) analysis of *very* vs. *much*).

Consider for example the case of *very*. Both (positive form) *tall* and *very tall* require an object to exceed a contextual standard of height, but the standard of comparison introduced by the latter is greater than that used by the former. Implementing proposals in Wheeler (1972) and (1980), we derive this result by assuming that *very* adjusts the **stnd** function associated with its argument (a gradable adjective to which the lexical rule in (9) has applied) so that it computes a standard of comparison based on just the heights of those objects that its argument is true of.



That is,  $[_{AP} \textit{very tall}]$  is (syntactically and semantically) just like  $[_{AP} \textit{tall}]$ , except that the standard of comparison for the former is computed by considering only those objects that count as tall in the context of utterance. General principles of informativity ensure that the modified **stnd** function will select a new standard of comparison partitions the domain of  $[_{AP} \textit{very tall}]$  into things it is true of and things it is false of, effectively boosting the base standard associated with  $[_{AP} \textit{tall}]$  (i.e., some tall objects will not count as very tall).

This proposal is made explicit in (12).

$$(12) \quad \left[ \begin{array}{l} \textit{very} \\ \text{syn} \left[ \begin{array}{l} \text{head } \textit{int} \\ \text{val} \left[ \begin{array}{l} \text{mod } \langle \textit{adj} \rangle \end{array} \right] \end{array} \right] \\ \text{sem} \left[ \begin{array}{l} \text{restr } \left\langle \begin{array}{l} \text{reln } \mathbf{very} \\ \text{arg1 } \mathbf{stnd} \\ \text{arg2 } \textit{d} \end{array} \right\rangle \end{array} \right] \end{array} \right]$$

Syntactically, the iterativity of intensifiers argues for combination via a Head-Modifier structure; for the purposes of illustration, we adopt Kasper's (1997) treatment of nonintersective modification, where the MOD feature is split up into information about the ARGument of the modifier (including its internal content) vs. the (External) CONtEnt of the resulting phrase. (13) illustrates the analysis of *very tall*.

$$(13) \quad \left[ \begin{array}{l} \textit{very tall} \\ \text{syn} \left[ \begin{array}{l} \text{head } \boxed{4} \\ \text{val } [\text{spec } \langle \rangle] \end{array} \right] \\ \text{sem} \left[ \begin{array}{l} \text{index } \boxed{2} \\ \text{restr } \langle \boxed{5}, \boxed{6} \rangle \end{array} \right] \end{array} \right]$$
  

$$\left[ \begin{array}{l} \textit{very} \\ \text{syn} \left[ \begin{array}{l} \text{head } \textit{int} \\ \text{val} \left[ \begin{array}{l} \text{mod } \langle \textit{adj} \rangle \end{array} \right] \end{array} \right] \\ \text{sem} \left[ \begin{array}{l} \text{restr } \left\langle \boxed{6} \left[ \begin{array}{l} \text{reln } \mathbf{very} \\ \text{arg1 } \boxed{1} \\ \text{arg2 } \boxed{3} \end{array} \right] \right\rangle \end{array} \right] \end{array} \right]$$
  

$$\left[ \begin{array}{l} \text{syn} \left[ \begin{array}{l} \text{head } \boxed{4} \textit{adj} \\ \text{val } [\text{spec } \langle \rangle] \\ \text{index } \boxed{2} \end{array} \right] \\ \text{sem} \left[ \begin{array}{l} \text{restr } \left\langle \boxed{5} \left[ \begin{array}{l} \text{reln } \mathbf{tall} \\ \text{arg1 } \boxed{2} \textit{r} \\ \text{arg2 } \boxed{3} \textit{t} \end{array} \right], \left[ \begin{array}{l} \text{reln } \boxed{1} \mathbf{stnd} \\ \text{arg1 } \boxed{3} \end{array} \right] \right\rangle \end{array} \right] \end{array} \right]$$

Since *very tall* itself is a predicate whose meaning is stated in terms of the **stnd** function, nothing precludes further intensification, deriving the result that intensifiers can modify intensifier+adjective combinations. At the same time, our

analysis explains why measure phrases (or rather, measure phrase + adjective combinations) cannot be intensified, even though their semantic (and syntactic) type should in principle allow for it. The difference between  $[_{AP} \text{ MP A}]$  (a type  $\langle e, t \rangle$  predicate consisting of a measure phrase plus gradable adjective) and  $[_{AP} \text{ A}]$  (a positive form gradable adjective to which the rule in (9) has applied) or  $[_{AP} \text{ Int A}]$  (an intensifier plus gradable adjective combination) is that the standard of comparison for the latter two structures is defined in terms of the **stnd** function, while that of the former is defined in terms of the measure phrase. As a result, there is no value for an intensifier to manipulate, and the addition of an intensifier has no semantic effect.

### 3.4 Scale adjusters

Finally, we consider the case of comparatives and related morphology (perhaps *too/enough*, after they have been saturated by their internal (clausal) arguments, though we have not yet explored these constructions), our ‘scale adjusters’. As outlined above, we claim that these expressions are also a type of modifier, but they are not traditional  $\langle \langle e, t \rangle, \langle e, t \rangle \rangle$  predicate modifiers. Instead, they are modifiers of ‘bare’ gradable adjectives (adjectives that have not undergone the positive form type-shifting rule) — expressions of type  $\langle \langle d, \langle e, t \rangle \rangle, \langle d, \langle e, t \rangle \rangle \rangle$ . Specifically, we claim that these expressions modify the adjective they take as input by resetting the maximal or minimal value (depending on the morpheme) of the scale onto which the adjective maps its argument to the degree introduced by the comparative clause.

To see how this works, we must first step back a bit and look at the semantics of gradable adjectives. Following a long tradition of work on this topic, we have assumed that an adjective like *tall* expresses a relation between a degree  $d$  and an individual  $x$  such that  $x$ ’s height is at least as great as  $d$  (see e.g. Cresswell, 1977; Heim, 1985; von Stechow, 1984; Klein, 1991; Kennedy, 1999; Kennedy and McNally, 2005, for representative discussion). This presumes that every gradable adjective includes as part of its meaning a measure function: a function from individuals to degrees on a scale. Our proposal is that it is this part of the meaning of an adjective that is manipulated by scale adjusting morphology.

Consider the case of a comparative of superiority *more than CP* (where CP is the comparative clause). We propose that this expression takes a gradable adjective and assigns to it a new scale whose minimal value is the degree denoted by CP (cf. Rotstein and Winter, 2004). Thus if *tall* is a relation between objects and degrees on the height scale that originate at zero and range towards infinity, *taller than the Empire State Building* is a relation between objects and degrees on that subpart of the height scale whose minimal value is the maximum height of the Empire State Building. The measure function component of *taller-than-the-Empire-State-Building* must be further constrained to return an object’s actual height for all objects whose height is greater than that of the Empire State Building, and ‘zero’ for objects whose height is equal to or less than the Empire State Building (where ‘zero’ is relative to the derived scale; the height of the Empire State Building itself).

Our syntactic and semantic analysis is illustrated in (14) (where we treat *more than CP* as a constituent for convenience; in principle the degree term could combine first with the adjective and second with the *than* constituent) and (15).

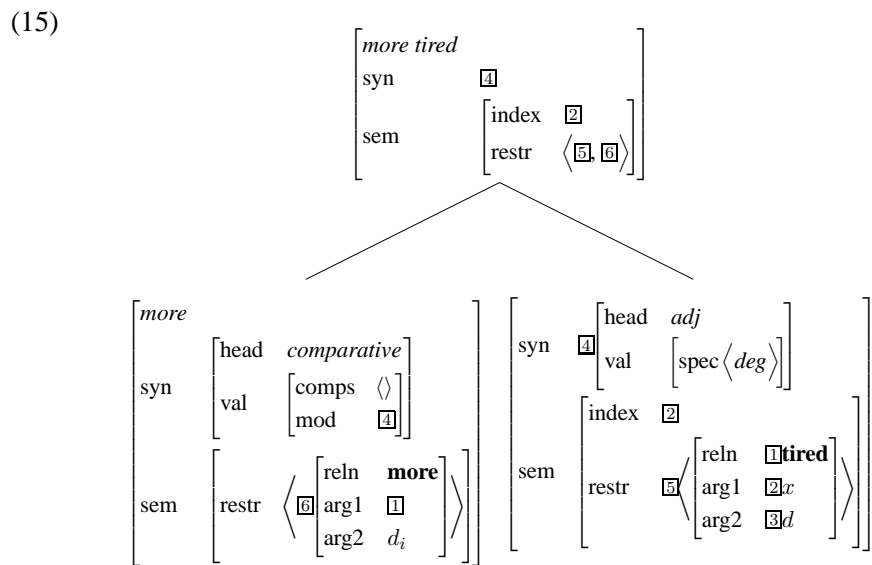
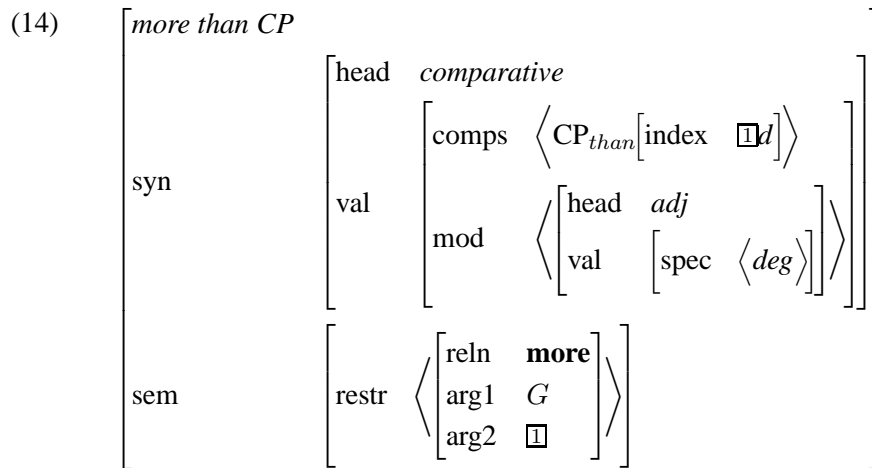

The result of this analysis is that expressions consisting of an adjective plus comparative morphology are of the same semantic and syntactic type as ‘bare’ gradable adjectives. It follows that they may be further modified by another comparative (assuming the result is a coherent meaning), allowing for the possibility of multiple comparatives such as (16), which were discussed by Kennedy (1997) (see also Pollard and Sag, 1994; Bhatt and Pancheva, 2004).

- (16) a. Dole isn’t as much more conservative than Clinton as Buchanan is.  
 b. Maverick’s is more too dangerous to surf today than it was yesterday.

It also follows that comparative adjective constructions must ultimately either

undergo the positive form rule in (9) or combine with a true degree morpheme (e.g. a measure phrase) in order to derive a property of individuals. Assuming **stnd** is defined in such a way that the positive form of an adjective that uses a scale with a minimal element is true of an object as long as it has a non-minimal degree of the relevant property (see Kennedy and McNally, 2005), the result is that *taller than CP* is true of an object if its height exceeds the zero value of the derived scale, which corresponds to the degree denoted by the CP. Thus *taller than the Empire State Building*, after undergoing the positive form rule, will denote a property that is true of an object just in case its height exceeds the height of the Empire State Building, which is exactly what we want.

### 3.5 Relation to previous work

As noted at the beginning, the most important previous work on degree expressions in HPSG comes from two sources. The first is Pollard and Sag (1994), who assume a Specifier analysis for the full range of degree expressions; as a result, multiple degree modification is treated in a left-branching fashion. This work does not include full semantic analysis, therefore it is difficult to define specific predictions about the restrictions on various combinations of multiple degree modifiers (such as the impossibility of layering intensifiers on top of true degree morphemes, as in our analysis). The second is Abeillé and Godard (2003), who develop a syntactic and semantic analysis of French degree adverbs using Head-Adjunct structures. This work does not address the full range of degree expressions or multiple degree modification, however, and so does not have the coverage of the current proposal.

Our analysis builds on this work, and in fact preserves aspects of both of these analyses (see also Doetjes (1997)). First, it adopts the Adjunct analysis for certain degree expressions, but refines it by providing (at least in English) for two types of degree Adjuncts: those that operate on bare adjectives (as measure relations), and those that operate on the output of the positive form lexical rule. Second, it adopts Specifier analysis for “true” degree modifiers, but significantly reduces the class of expressions that have this specifying function.

A prediction of our analysis is that iterations both of comparatives and of intensifiers must be interpreted in a right-branching fashion, rather than in the left branching fashion predicted on the Specifier analysis. The fact that (17) has the interpretation in (17a), rather than (17b), supports this conclusion.

- (17) a. Becca was rather very slightly drunk last night.  
       ([www.elvislovers.fanspace.com/fsguestbook.html](http://www.elvislovers.fanspace.com/fsguestbook.html))  
       b. (rather (very (slightly)))  
       c. ((rather (very))(slightly))

## 4 Concluding remarks

The general empirical claim in this paper has been that degree modification is syntactically and semantically diverse: the class of degree expressions is subdivided both according to the semantic effects of its members and according to the extent to which they permit, and participate in, multiple layers of modification. These two factors are linked, and result in (at least) the three-way distinction we have drawn in this paper between true degree morphemes, intensifiers, and scale modifiers.

Our HPSG implementation of the syntax and semantics of degree modification accounts for the diversity of the class by analyzing intensifiers and scale adjusters as expressions that combine with their semantic arguments in Head-Adjunct structures, while true degree morphemes combine with their arguments in a Head-Specifier structure. Our analysis thus resembles Abeillé and Godard's insofar as they argue for a Head-Adjunct analysis of French degree adverbs. It refines their proposal in allowing (at least in English) for two types of degree Adjuncts: those that operate on 'bare adjectives' (measure functions), and those that operate on gradable APs (i.e., on the **stnd** function introduced by the positive form). Kennedy and McNally's (2005) comments concerning the semantics of the degree modifier *well* indicate that these two types are clearly justified.

Nonetheless, the analysis also preserves the essence of the insight behind Polard and Sag's proposal, on which degree expressions are treated as specifiers of adjectives, adverbs or other gradable predicates in a Head-Specifier configuration. It simply reduces the class of expressions that have this specifying function, as a result of having refined the semantics of degree modification.

A question of broader theoretical interest is why the set of degree expressions should be divided up in the way we have proposed here. We claim that this is a natural result of our initial assumptions that gradable adjectives have basic meanings as relations between degrees and individuals (type  $\langle d, \langle e, t \rangle \rangle$ ) and 'derived' meanings (in the positive form) as context-dependent properties of individuals (type  $\langle e, t \rangle$ , where context dependence comes from the **stnd** function). If the basic semantic type of a gradable adjective is  $\langle d, \langle e, t \rangle \rangle$ , then there should exist overt morphology (in addition to our positive form lexical rule) that converts a gradable adjective to a property of individuals: this is our class of true degree morphemes. Furthermore, if natural language quite generally allows expressions of type  $\langle \tau, \tau \rangle$ , there should also exist a class of modifiers of 'bare' gradable adjectives: these are our scale adjusters. By the same token, we also expect to find modifiers of the type  $\langle e, t \rangle$  variant of a gradable adjective (the positive form): this is our class of intensifiers.

## References

- Abeillé, Anne and Godard, Danièle. 2003. The Syntactic Flexibility of French Degree Adverbs. In Stefan Müller (ed.), *Proceedings of the 10th International Con-*

- ference on Head-Driven Phrase Structure Grammar*, pages 26–46, Stanford, CA: CSLI Publications.
- Barker, Chris. 2002. The Dynamics of Vagueness. *Linguistics and Philosophy* 25(1), 1–36.
- Bartsch, Renate and Vennemann, Theo. 1972. The Grammar of Relative Adjectives and Comparison. *Linguistische Berichte* 20, 19–32.
- Bhatt, Rajesh and Pancheva, Roumyana. 2004. Late Merger of Degree Clauses. *Linguistic Inquiry* 35, 1–46.
- Bogusławski, Andrzej. 1975. Measures are Measures: In Defence of the Diversity of Comparatives and Positives. *Linguistische Berichte* 36, 1–9.
- Corver, Norbert. 1997. Much-Support as a Last Resort. *Linguistic Inquiry* 28, 119–164.
- Cresswell, M. J. 1977. The Semantics of Degree. In Barbara Partee (ed.), *Montague Grammar*, pages 261–292, New York: Academic Press.
- Doetjes, Jenny. 1997. *Quantifiers and Selection*. Ph. D.thesis, Rijksuniversiteit Leiden, Leiden.
- Graff, Delia. 2000. Shifting Sands: An Interest-Relative Theory of Vagueness. *Philosophical Topics* 20, 45–81.
- Heim, Irene. 1985. Notes on Comparatives and Related Matters, ms., University of Texas.
- Kasper, Robert T. 1997. The Semantics of Recursive Modification, ms., Ohio State University.
- Kennedy, Christopher. 1997. Comparison and Polar Opposition. In Aaron Lawson (ed.), *Semantics and Linguistic Theory* 7, Ithaca, NY: CLC Publications.
- Kennedy, Christopher. 1999. *Projecting the Adjective: The Syntax and Semantics of Gradability and Comparison*. New York: Garland, (1997 UCSC Ph.D thesis).
- Kennedy, Christopher. 2002. Comparative Deletion and Optimality in Syntax. *Natural Language & Linguistic Theory* 20.3, 553–621.
- Kennedy, Christopher. 2005. Vagueness and Grammar: The Semantics of Relative and Absolute Gradable Predicates, ms., University of Chicago.
- Kennedy, Christopher and McNally, Louise. 2005. Scale Structure and the Semantic Typology of Gradable Predicates. *Language* 81(2), 345–381.
- Klein, Ewan. 1980. A Semantics for Positive and Comparative Adjectives. *Linguistics and Philosophy* 4, 1–45.

- Klein, Ewan. 1991. Comparatives. Chapter 32, pages 673–691, Berlin: de Gruyter.
- Lewis, David K. 1970. General Semantics. *Synthese* 22, 18–67.
- Pollard, Carl and Sag, Ivan. 1994. *Head-Driven Phrase Structure Grammar*. Chicago: University of Chicago Press.
- Rotstein, Carmen and Winter, Yoad. 2004. Total Adjectives vs. Partial Adjectives: Scale Structure and Higher-Order Modifiers. *Natural Language Semantics* 12, 259–288.
- von Stechow, Arnim. 1984. Comparing Semantic Theories of Comparison. *Journal of Semantics* 3, 1–77.
- Wheeler, Samuel. 1972. Attributives and Their Modifiers. *Noûs* 6(4), 310–334.

# English object extraposition: A constraint-based approach

Jong-Bok Kim   
Kyung Hee University

Ivan A. Sag  
Stanford University

Proceedings of the 12th International Conference on  
Head-Driven Phrase Structure Grammar

Department of Informatics, University of Lisbon

Stefan Müller (Editor)

2005

Stanford, CA: CSLI Publications

pages 192–212

Kim, Jong-Bok & Ivan A. Sag. 2005. English object extraposition: A constraint-based approach. In Stefan Müller (ed.), *Proceedings of the 12th International Conference on Head-Driven Phrase Structure Grammar, Department of Informatics, University of Lisbon*, 192–212. Stanford, CA: CSLI Publications. DOI: 10.21248/hpsg.2005.11.





## Abstract

According to the Projection Principle (Chomsky 1981), expletives have no semantic content and thus cannot occur in theta-marked positions. However, there are many examples where expletive *it* appears as a direct object, in violation of the Projection Principle. The various attempts that have been made to account for such cases (e.g. the case-based analysis of Authier (1991), the predication analysis of Rothstein (1995), and the Specifier analysis of Stroik (1991, 1996)) all posit movement of the expletive from a non-theta marked position to direct object position. However, these analyses have so far been unsuccessful in capturing several important contrasts, e.g. variable optionality of the expletive *it*. This paper argues that such contrasts (and the complex behavior of expletive *it* more generally) follow straightforwardly from a lexicalist, constraint-based analysis in which lexical information and independently motivated constraints interact in subtle ways.

## 1 Extraposition: the Issue

English allows a pattern where a finite or infinitival clause appears in sentence-final (or ‘extraposed’) position (cf. Quirk et al. 1985):

- (1) a. I made it my objective [to settle the matter].  
b. I owe it to you [that the jury acquitted me].

This pattern involves the introduction of expletive (or ‘dummy’) *it* which, though morphologically identical to the third person singular pronoun, is not referential, and hence is unable to be assigned any semantic role. Expletives also exhibit distinctive syntactic properties, as noted by Postal and Pullum (1988):

- (2) a. For him to smoke is itself illegal.  
b. \*It is itself illegal for him to smoke.
- (3) a. my observation/description of it falling  
b. \*my observation/description of it raining
- (4) a. The animal<sub>i</sub> was now quite large, and it<sub>i</sub> was tough to prevent from escaping.  
b. \*It was tough to prevent from becoming obvious that things were out of control.

---

An earlier version of this paper was presented at the 41st Chicago Linguistic Society at the the University of Chicago on April 8, 2005 and the HPSG 2005 at the University of Lisbon on Aug 24th, 2005. We thank the audiences of the two conferences. In particular, we thank Frank Van Eynde, Stefan Müller, Carl Pollard, and Peter Sells for suggestions and clarifications.

These contrasts illustrate the differences between anaphoric and expletive *it*. Unlike the anaphoric pronoun, the expletive in (2b) does not support an emphatic reflexive *itself*. In (3), we see that only referential *it* can appear in the nominalizations that are permitted in *of*-phrases. Finally, expletives cannot occur as the subject of a *tough*-predicate, as shown in (4b).

According to the Projection Principle (which was proposed essentially without argument by Chomsky (1981) and has been widely assumed within mainstream generative grammar), the expletive pronoun, which has no semantic content, cannot occur in any theta-position. This entails that expletives cannot appear in strictly subcategorized positions. However, it is well known that there are overt cases where the expletive *it* does occur in a strictly subcategorized object position, as in (5) [Postal & Pullum 1988]:

- (5) a. Sometimes I find it difficult to read my own writing.
- b. She's put it in their mind that it's going to be really tough.
- c. I take it for granted that there will be an appeal.

A number of attempts have been made to account for such cases, mainly from a transformational perspective. However, to our knowledge, none has provided a satisfactory account of the contrast that we find in examples like the following (cf. Authier 1991, Iwakura 1991, 1994):

- (6) Group I: I blame \*(it) on you [that we can't go].
- Group II: Nobody expected (it) of you [that you could be so cruel].
- Group III: John thought (?it) to himself [that we had betrayed him].

With respect to the occurrence of the expletive *it* in object position, there exists a clear contrast here: the expletive is obligatory in Group I, optional in Group II, and of questionable status in Group III.

In this paper, we show that these contrasts, in addition to the distributional possibilities of *it* in object position, follow naturally from the interaction of diverse constraints in our lexicalist, constraint-based analysis.

## 2 Movement-Based Approaches

**Small Clauses.** Before presenting our analyses, we briefly review the most promising of the previous approaches that have been taken regarding object extraposition. As already mentioned, Postal and Pullum (1988) provided extensive evidence supporting the claim that expletive *it* can appear in subcategorized positions. The only way of saving the Projection Principle then seems to be to regard the expletive *it* in the object position as being the subject of a small clause. The small clause analysis seems to fit cases like the following:

- (7) a. I believe *SC*[it to be obvious that he has lost].
- b. We kept *SC*[it a secret that Jerome was insane].

However, as Postal and Pullum point out, the small clause account appears to be inconsistent with the existence of examples like (8):

- (8) a. They never mentioned *SC*[it [to the candidate] that the job was poorly paid].
- b. We can take *SC*[it [for granted] that there will be an appeal].

The matrix PP would have to somehow descend into the embedded clause.

There are additional cases where the expletive *it* functions as a subcategorized element of the main verb. For example, it is hard to deny that the particle *out* in (9a) is in construction with the main verb in Postal and Pullum's examples like (9b):

- (9) a. I figured [it out in about five minutes to be impossible to solve the problem].
- b. \*I figured in about five minutes it out to be impossible to solve the problem.

Despite this fact, as the bracketings in (9a) indicate, the small clause forces us to separate the particle from the verb.

Postal and Pullum's observations thus raise a fundamental challenge to the Projection Principle, one that has been responded to in an interesting paper by Rothstein (1995). In the next section, we review her conclusions briefly, but critically.<sup>1</sup>

**Rothstein 1995.** Rothstein (1995) claims that the expletive *it* is licensed only as subject based on the following two assumptions:

- (10) Predication Condition: Every syntactic predicate must be syntactically saturated. (Rothstein (1995: (15))
- (11) Pleonastics are licensed only as subjects of syntactic predicates that do not assign an external theta role. (Rothstein (1995: (26))

In her analysis, a syntactic predicate is defined to be an open maximal projection that needs to be saturated by being linked to a syntactic argument, its subject. This approach thus implies that there is no pleonastic *it* in the object position; the pronoun *it* in the object position is either a subject or a referential pronoun. In examples like (12), for example, the expression following the expletive is to function as the extraposed clause's predicate:

---

<sup>1</sup>There are two other movement-based approaches to the data in question that we are familiar with: the case-based approach of Authier (1991) and the 'SPEC of CP' analysis of Stroik (1991, 1996). These are also flawed in various respects, as noted in Kim and Sag forthcoming.

- (12) a. I consider \*(it) obvious that you should have done that.  
 b. I found \*(it) stupid that Mary didn't say anything.

But it is unclear how to reconcile the predication analysis with examples where we can find no possible predicate at all or those where the object *it* is optional (examples from Rothstein 1995):

- (13) a. He regretted (it) that he was late.  
 b. You just believed (it) that he would help.  
 c. He never mentioned (it) to the candidate that the job was poorly paid.

Rothstein assumes that the pronoun *it* in (13a) is an event variable bound by the CP. This in turn means that the CP here is predicated of the event object of the matrix verb. And the pronouns *it* in (13b) and (13c) are linked to the right-dislocated CP.<sup>2</sup>

As many have pointed out (e.g. Collins (1994) and Huddleston and Pullum (2001)), it is quite difficult to differentiate extraposition (EX) from right dislocation (RD), though some differences are apparent. The prototypical RD construction has an NP shifted outside as in (14), and to the right of the governing clause, whereas the prototypical EX has a nominal clause shifted to the right of the predicate:

- (14) It causes him a lot of embarrassment, his receding hairline.

In addition, the pronoun *it* in RD has a referential function, whereas the one in EX has no referential power:

- (15) a. RD: It annoyed us both, having to do the calculations by hand.  
 b. EX: It annoyed us both that we had to do the calculations by hand.

Prosody can also serve to differentiate the constructions in general. A RD sentence is normally spoken with two intonational phrases – the first with a primary accent on *fun* and the second with deaccenting of *parasailing*. This contrasts with the EX rendition, where there is only one such unit containing an accent on *parasailing*:

---

<sup>2</sup>Within her analysis, the *it* + CP sequences have at least two different types of analysis: one as event quantification; the other as right dislocation. Verbs like *regret*, *confirm*, *resent*, and *announce* receive the former analysis; verbs like *suspect*, *assume*, *suppose*, *expect*, *believe*, and *mention* get the latter. The claimed differences are that only the event-quantification verbs can take gerund complements or occur with an event quantifier:

- (i) a. Alexander regretted that he had destroyed the city/the prize/destroying the city/the destruction of the city.  
 b. Alexander regretted it every time I had dinner with John.  
 (ii) a. \*They suspected/assumed/expected John's stealing the diamonds.  
 b. \*They suspected/assumed/expected/supposed it every time he told a lie.

- (16) a. RD: It was fun, parasailing.  
 b. EX: It was fun parasailing.

In other words, the right peripheral element in RD is intoned as an afterthought.

And none of Rothstein's examples require the RD prosodic pattern. They all allow the primary accent to be realized within the *that*-clause, i.e. they allow the prosodic pattern that is characteristic of EX, not RD.<sup>3</sup>

In addition, as Huddleston and Pullum (2001) point out, right-dislocated material is required to be 'discourse old', whereas the extraposed constituent may be 'discourse new':

- (17) a. RD:#It's really interesting, a book I'm reading.  
 b. EX: It now seems that there will be another price increase soon.

But there are certainly examples like Rothstein's in (13b,c) that allow indefinites introducing discourse-new referents, e.g. the following:

- (18) a. If you could just suppose it that there's a REAL FIRE downstairs.  
 b. I want you to mention it to the class that there's a NEW KID there.

Rothstein must thus analyze as RD, examples that exhibit neither the prosodic properties nor the discourse properties of RD – a highly undesirable consequence.

Similarly, Rothstein's analysis implies that if the pronoun is obligatory then there must be a predication relation. However, there are quite a few examples where the pronoun *it* is obligatory without there being any predication relation:

- (19) a. I depend upon \*(it) that their paper will expose crooked politicians.  
 b. I figured \*(it) out to be more than 300 miles from here to Tuscon.

Her analysis takes prepositional extraposition examples like (19a) as 'adjunct predicate constructions' analogous to examples like (20):

- (20) You can't count on/depend on him drunk. (Rothstein 1998: (91))

However, this neglects the fact that the CP in (19a) is not an optional element, unlike *drunk*. Extraposed CPs like those in (19) don't seem to share any properties with adjuncts.

In addition, we can easily find examples where the presence of the object *it* is obligatory, although nothing is plausibly analyzed as a predicative expression:

- (21) a. Optimistic leaks had it that the negotiators were making good progress on a statement of "principles".

---

<sup>3</sup>Note that RD also allows the pronoun *that*, which EX does not.

- b. I love it that you've asked me to go away.<sup>4</sup>

Such examples cast further doubt on Rothstein's proposal. All things considered, an analysis that can treat all of these examples as instances of expletive *it* is to be preferred.

### 3 A Lexicalist Analysis

**Lexical Classes.** As we have already seen, it is sometimes thought that the verbs allowing object *it*-extraposition form a restricted class. For example, it is clear (v. Authier 1991) that verbs that allow a choice between a clausal complement and an NP object will license object extraposition:

- (22) a. They didn't even mention his latest promotion/that he was promoted recently.  
b. They demanded justice/that he should leave.  
c. He said many things/that I was not the person he was looking for.
- (23) a. They never mentioned it to the candidate that the job was poorly paid.  
b. They demand it of our employees that they wear a tie.  
c. He wouldn't dare say it that I am not the right man for the job.

Unlike these, it seems, at least at first blush, that propositional object verbs like *hint* and *think*, which select a single CP complement, cannot undergo extraposition:

- (24) a. I think \*(of) you all the time.  
b. He hinted \*many things/that I was not the person he was looking for.
- (25) a. I think (??it) that John had an accident.  
b. He wouldn't dare hint (?it) that I am not the right man for the job.

However, more careful investigation reveals many naturally occurring examples of object extraposition with such verbs, as can be seen from the following examples found on the internet:

- (26) a. ...because he really obviously thought it that it was somehow going to work out to his benefit.<sup>5</sup>

---

<sup>4</sup>From the BNC

<sup>5</sup>[www.bazima.com/archives/before/2004/12/not-only-is-she.htm](http://www.bazima.com/archives/before/2004/12/not-only-is-she.htm) [April 15, 2005]

- b. The Auditor would not be able to pick it up unless somebody hinted it that the account existed.<sup>6</sup>

We speculate that the true generalization is that all verbs (modulo certain qualms about verbs taking interrogative complements) that allow CP (or sentential) objects also allow object *it*-extraposition.

To reflect such lexical patterns, we will assume, following much work in HPSG, that parts of speech come in families and can profitably be analyzed in terms of typed feature structures. The part-of-speech types we will assume form the hierarchy illustrated in (27):<sup>7</sup>

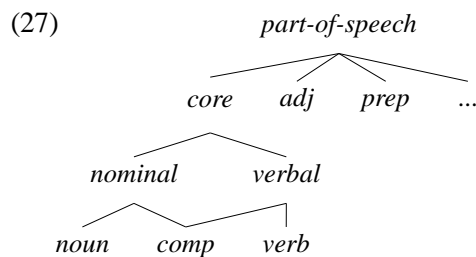

The type *nominal* is thus a supertype of both *noun* and *comp*. In accordance with the basic properties of systems of typed feature structures, an element specified as [HEAD *nominal*] can be realized either as [HEAD *noun*] or [HEAD *comp*]. These will correspond to the phrasal types NP and CP, respectively.

The hierarchy implies that the subcategorization pattern of English verbs will refer to (at least) each of these types. For example, we can easily identify verbs whose subcategorization restrictions make reference to *nominal*, *noun*, and *comp*:

- (28) a. She pinched [his arm] as hard as she could.  
 b. \*She pinched [that he feels pain].
- (29) a. We hope [that such a vaccine could be available in ten years].  
 b. \*We hope [the availability of such a vaccine in ten years].
- (30) a. Cohen proved the independence of the continuum hypothesis.  
 b. Cohen proved that the continuum hypothesis was independent.

The *part-of-speech* type hierarchy in (27) allows us to formulate simple lexical constraints that reflect these subcategorization patterns. That is, we can assume that English transitive verbs come in at least the following three varieties:

<sup>6</sup>[www.stkittsnevis.net/archives/commission/coiday70.html](http://www.stkittsnevis.net/archives/commission/coiday70.html) [April 15, 2005]

<sup>7</sup>Following Postal (1966), we assume that determiners are really pronouns that select common NP complements and hence have *noun* as their part of speech type.

- (31) a.  $\left[ \text{SUBCAT} \langle \text{NP}, \text{NP}[\text{HEAD } \textit{noun}], \dots \rangle \right]$   
 b.  $\left[ \text{SUBCAT} \langle \text{NP}, \text{CP}[\text{HEAD } \textit{comp}], \dots \rangle \right]$   
 c.  $\left[ \text{SUBCAT} \langle \text{NP}, [\text{HEAD } \textit{nominal}], \dots \rangle \right]$

In each class, the SUBCAT list specifies the dependent elements that the verbs select (in the order  $\langle$  Subject, Direct Object, ...  $\rangle$ ). The HEAD value of a given element is the part-of-speech type that a word passes on to the phrases it projects. NP and CP are abbreviations for feature structure descriptions that include the information [HEAD *noun*] and [HEAD *comp*], respectively. Verbs like *hope* select either a CP, an S, or that the verbs select an infinitival VP. This means its complement is [HEAD *verbal*], whereas *try* selects only [HEAD *verb*] since it does not allow a CP clause.

**HPSG: Background Assumptions.** We assume here that complex phrases are licensed by grammatical constructions: schemata imposing constraints on how component signs can combine to build larger signs. The well-formed signs defined by our grammar are those that instantiate the mother of some construction. Two constructions of English will suffice for present purposes: the head-complement construction and the subject-predicate construction, given in the form of the construction types of Sag (2001, to appear), Sag et al. (2003), and related work:

- (32) a. 
$$\begin{array}{l} \text{hd-comp-cxt} \Rightarrow \left[ \begin{array}{l} \text{MTR} \quad \left[ \text{SYN|CAT|SUBCAT} \boxed{A} \langle \boxed{1} \rangle \right] \\ \text{DTRS} \quad \left\langle \boxed{0} \left[ \begin{array}{l} \textit{word} \\ \text{SS|C|SUBCAT} \boxed{A} \oplus \boxed{B} \end{array} \right] \right\rangle \oplus \boxed{B} \\ \text{H-DTR} \quad \boxed{0} \end{array} \right] \end{array}$$
- b. 
$$\begin{array}{l} \text{subj-pred-cxt} \Rightarrow \left[ \begin{array}{l} \text{MTR} \quad \left[ \text{SYN|CAT|SUBCAT} \langle \rangle \right] \\ \text{DTRS} \quad \left\langle \boxed{0} \left[ \text{SYN|CAT|SUBCAT} \langle \boxed{1} \rangle \right], \boxed{1} \right\rangle \\ \text{H-DTR} \quad \boxed{0} \end{array} \right] \end{array}$$

These constructions interact with general principles and the various (partly parochial) linear precedence constraints to license complex phrasal signs:

- (33) Three English Linear Precedence Constraints:

- LP1: **Hd-Dtr**[*word*]  $\prec$  X  
 LP2:  $\boxed{1} \prec [\text{SYN|CAT|SUBCAT} \langle \boxed{1} \rangle]$   
 LP3: NP  $\prec$  PP



LP1 says that a lexical head must precede all of its sisters, whereas LP2 ensures that a predicate selecting its subject follows that subject. Finally, LP3 requires that an NP precede any sister that is a PP.

The various SUBCAT constraints posited above for the different verb classes interact with the construction inventory, the general principles of HPSG theory, and with the LP constraints to account for the data we observed earlier. For example, *pinch* can select only an NP complement whereas *hope* can subcategorize only for a CP as its complement. Verbs like *prove*, *forget*, and *regret*, however, can cooccur with either NP or CP complements, because the part-of-speech type *nominal* subsumes both *noun* and *comp*. This basic picture sets the stage for our consideration of more complex data relevant to object extraposition.

**Two Regularities of English.** English exhibits a systematic alternation between pairs of non-extrapolated and extrapolated sentences like the following:

- (34) a. [That Chris knew the answer] occurred to Pat.  
b. It [occurred [to Pat] [that Chris knew the answer]].

The relation is productive. As English acquires new expressions, e.g. *freak out*, *weird out*, *suck*, or *bite*, it acquires both extrapolated and non-extrapolated sentence types (cf. Jackendoff 2002):

- (35) a. It really freaks/weirds me out that we invaded Iraq.  
b. That we invaded Iraq really freaks/weirds me out.  
(36) a. It really sucks/bites that we invaded Iraq.  
b. That we invaded Iraq really sucks/bites.

To capture the systematic relationship in subject extraposition, Pollard and Sag (1994) [see also Sag et al. 2003] introduced a lexical rule that turns the sentential subject in (35b) and (36b) into a sentential ‘complement’ of the verb in (35a) and (36a), respectively. However, as pointed out by Keller (1995), Bouma (1996), and van Eynde (1996), this complement analysis alone is incomplete. It does not allow for cases like the following:

- (37) a. They regret it [very much] [that we could not hire Mosconi].  
b. It struck a grammarian last month, [who analyzed it], [that this clause is grammatical].

Given the general assumption that VP modifiers cannot intervene between the head and its complement, the intervening occurrence of the VP adjunct *very much* or the appositive clause *who analyzed it* argues against taking extrapolated clause as the complement. In addition, as noted in Van Eynde (1996), the complement analysis fails to account for the following well-known contrast in extractability:

- (38) a. That Kim would lose to Pat, nobody had expected \_.  
 b. \*That Sandy snores, it bothers Kim more and more \_.

The clausal complement can be freely topicalized from complement position, but not from extraposed position.

Following in critical respects Bouma (1996), we take English extraposition to be a nonlocal dependency and introduce the nonlocal feature EXTRA together with the following lexical construction:<sup>8</sup>

(39) Extraposition Construction

$$\left[ \begin{array}{l} \text{MTR} \left[ \begin{array}{l} \text{PHON } \boxed{0} \\ \text{S|C} \left[ \begin{array}{l} \text{SUBCAT } \boxed{A} \oplus \langle \text{NP}[it] \rangle \oplus \boxed{B} \\ \text{EXTRA } \langle \boxed{1} \rangle \end{array} \right] \end{array} \right] \\ \text{DTRS} \left\langle \left[ \begin{array}{l} \text{PHON } \boxed{0} \\ \text{S|C|SUBCAT } \boxed{A} \oplus \langle \boxed{1}[\textit{verbal}] \rangle \oplus \boxed{B} \end{array} \right] \right\rangle \end{array} \right]$$

This rule creates new words whose feature specifications are minimally different and systematically related to those of other words that select S and/or CP complements. These new words select their S or CP complement not via the SUBCAT feature, but rather via EXTRA, a separate selection feature that will also be used in the analysis of other kinds of extraposition phenomena. An expletive NP (NP[it]) holds the place of the extraposed complement in the new word's SUBCAT list.<sup>9</sup>

EXTRA specifications will be passed up to a higher structure and discharged by the following Head-Extraposition Construction:<sup>10</sup>

(40) Head-Extraposition Construction:

$$hd\text{-extra}\text{-cxt} \Rightarrow \left[ \begin{array}{l} \text{MTR} \left[ \text{S|C|EXTRA } \langle \rangle \right] \\ \text{DTRS} \langle \boxed{0}, \boxed{1} \rangle \\ \text{H-DTR} \left[ \begin{array}{l} \boxed{0} \textit{phrase} \\ \text{S|C|EXTRA } \langle \boxed{1} \rangle \end{array} \right] \end{array} \right]$$

This construction reflects the fact that English independently allows phrases constructed by a head combining with an extraposed element, as illustrated in (41):

<sup>8</sup>Lexical constructions, as used here, are quite similar to phrasal constructions ('Phrasal Schemata' in the sense of Pollard and Sag 1994). For more discussion, see Sag et al. 2003, Chap. 16.

<sup>9</sup>This lexical construction may need to include a semantic restriction on the extraposed clause.

<sup>10</sup>The percolation of the feature EXTRA is either guaranteed by the Generalized Head Feature Principle of Ginzburg and Sag 2000 or else, making slightly different theoretical assumptions, by the Valence Principle of Sag et al. 2003.

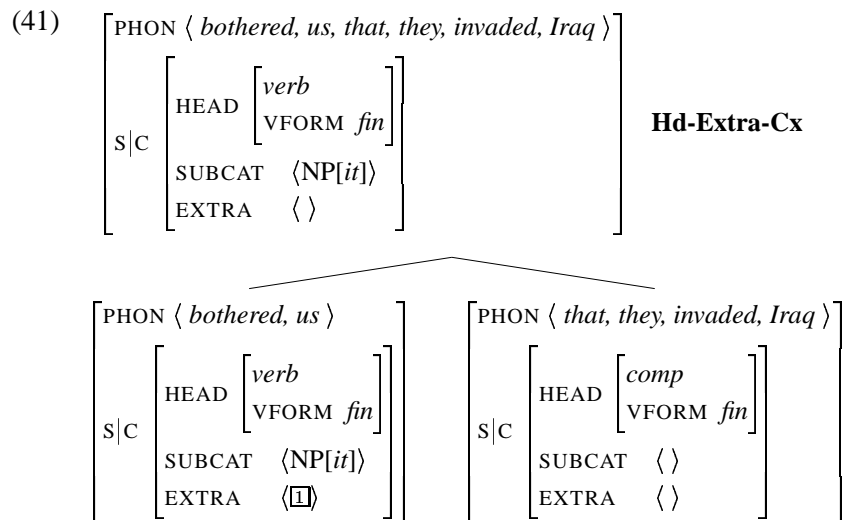

English freely employs this kind of construction for the extraposition of adjunct elements, as well (cf. Culicover and Rochemont 1990):

- (42) a. [[A man came into the room] [that no one knew]].  
 b. [[A man came into the room] [with blond hair]].  
 c. I [[read a book last week] [which was about Chomsky]].

All these examples are licensed by the Head-Extrapolation Construction.

One additional constraint relevant to extraposition phenomena involves the possible orderings of CPs and Ss with respect to other constituents. The essential insight was formulated by Kuno (1987) as his Ban on Non-sentence Final Clause (BNFC), which prohibits a CP or S from having any element to its right:

- (43) a. \*Would [that John came] surprise you?  
 b. Would it surprise you [that John came]?

- (44) a. \*Would [to pay now] be better?  
 b. Would it be better [to pay now]?

- (45) a. \*I explained that the world is round to them.  
 b. I explained to them that the world is round.

The BNFC constraint basically bars any argument from appearing after a sentential argument. In the present context, we can incorporate the insight of this functionally motivated constraint via a (language-particular) LP constraint:

(46) LP4: Complement  $\prec$  [SYN|CAT|HEAD *verbal*]

LP4 says that any sign whose HEAD value is *verbal* must occur after any of its complement sisters.

**Group I.** As noted earlier, verbs like *blame* require the presence of the expletive *it* in object position:

- (47) a. I blame [the case] on you.  
 b. \*I blame [that we can't go].  
 c. \*I blame [that we can't go] on you.  
 d. I blame it on you [that we can't go].  
 e. \*I blame on you [that we can't go].

These data imply that verbs like *blame* will have the following SUBCAT information:

$$(48) \left[ \text{S|C|SUBCAT} \left\langle \text{NP}, \square[\text{S|C|HEAD } \textit{nominal}], \left[ \text{S|C} \left[ \begin{array}{c} \text{PP} \\ \text{HD|PFORM } \textit{on} \\ \text{SUBCAT } \langle \square \rangle \end{array} \right] \right] \right\rangle \right]$$

The verb *blame* selects for a *nominal* object and a PP[*on*] argument. Note that the PP is predicational, i.e. it has a single element on its SUBCAT list and this element is identified with the object, its (raising) controller. This analysis of PP[*on*]s is motivated by examples like (49a,b):

- (49) a. They placed the blame on us.  
 b. The blame was on us.

In these examples, the predicational nature of PP[*on*] is clear and plays a key role in our semantic analysis, e.g. in explaining why (49a) entails (49b).

In (48), the object's part of speech is of type *nominal*. Hence that element can be resolved to NP, as in (47a). This can also be resolved to CP, yet this resolution cannot give rise to any linearization. The CP–PP ordering in (47c) is a violation of the BNFC constraint LP4 (see (46) above) and the PP–CP ordering in (47e) violates LP2, which requires a controller to precede any sister that it controls, e.g. the PP[*on*]. Hence any attempt to resolve the object in (48) to CP leads to a violation of some independently motivated constraint.

Notice here that when the *nominal* is realized as its subtype *comp* that can project into a CP, it can get 'pumped' by the Extraposition Construction (since *comp* is a subtype of *nominal*), as shown in (50):

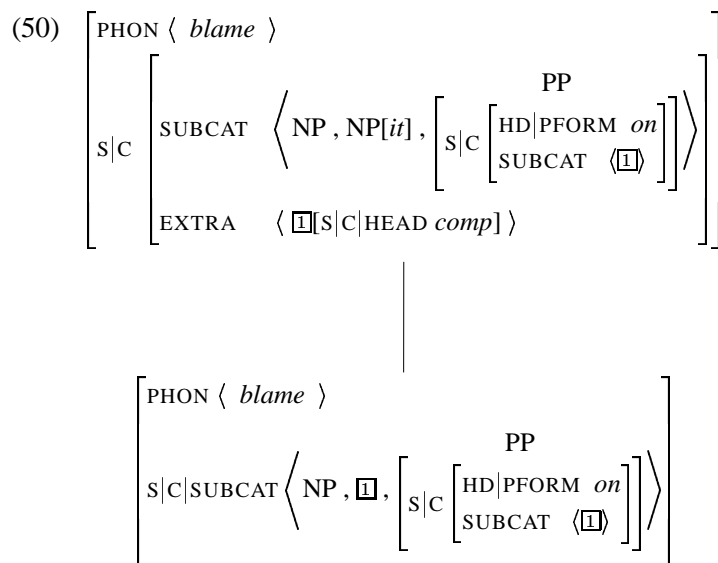

The lexically constructed word (the mother) in (50) gives rise to the example in (47d) whose partial structure is given in Figure 1. As noted, in order for the verb *blame* to realize its complement as a clause (CP), it must first get pumped by the Extraposition Construction, which will ensure that an expletive *it* object is also present.

Most of the object extraposition examples, in addition to an object argument, subcategorize for a predicative XP complement. If this predicative XP is obligatory and the object complement is realized as a CP, then we expect the object will have to be extraposed in order to avoid the effects of the BNFC Constraint – LP4. This prediction is borne out:

- (51) a. I made it my objective [to settle the matter].  
 b. \*I made [to settle the matter] my objective.  
 c. I made [the settlement of the matter] my objective.
- (52) a. I owe it to you [that the jury acquitted me].  
 b. \*I owe [that the jury acquitted me] to you.  
 c. I owe [my acquittal] to you.

Verbs like *made* and *owe* select an object and a non-optional predicative XP. This means that when the object is realized as a CP and extraposed to the sentence final position, the expletive also must occur.

**Group II.** In the Group II examples, expletive *it* is optional, as noted earlier. The behavior of a verb in this group is illustrated by the following data set:

- (53) a. Nobody expected [his success].

Figure 1: An Object-Extrapolation Structure

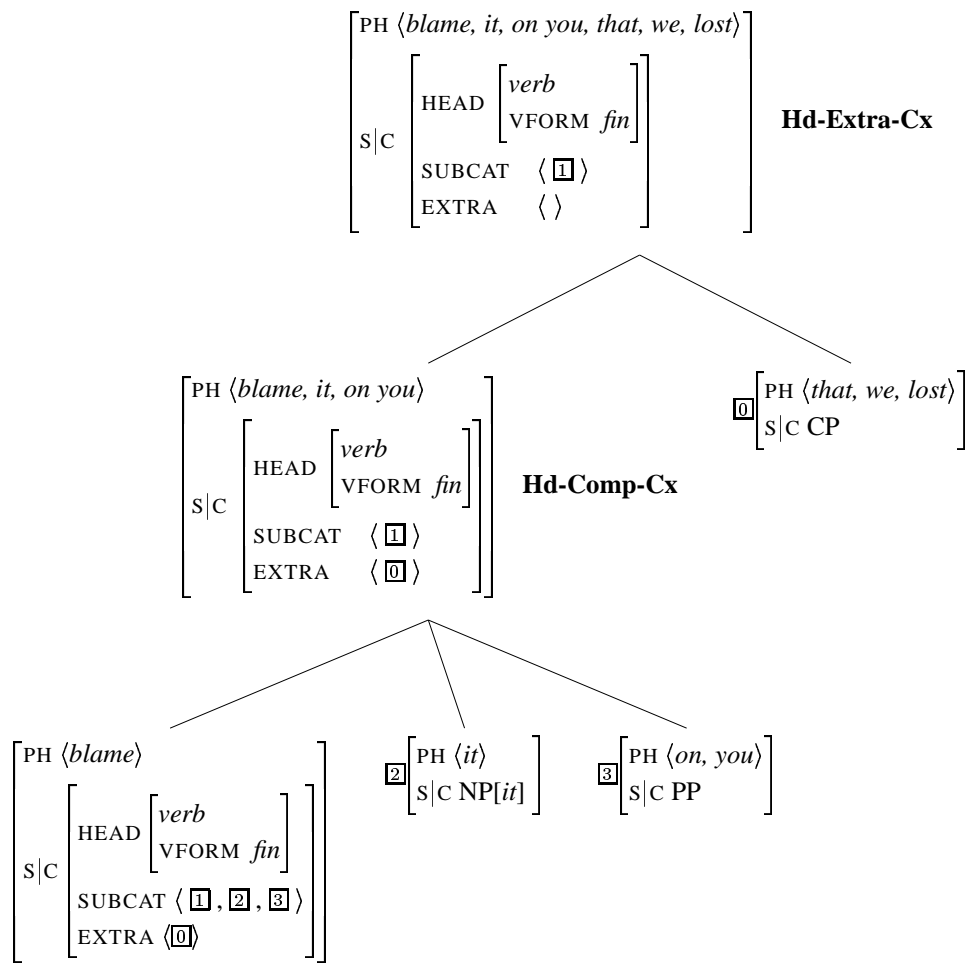

- b. Nobody expected [anything] of me.
- c. Nobody expected [that you could be so cruel].
- d. \*Nobody expected [that you could be so cruel] of you.
- e. Nobody expected it of you [that you could be so cruel].
- f. Nobody expected of you [that you could be so cruel].
- g. Nobody expected [you could be so cruel].
- h. \*Nobody expected [you could be so cruel] of you.
- i. ?Nobody expected of you [you could be so cruel].
- j. ?Nobody expected it of you [you could be so cruel].

These examples suggest that the lexical entries of verbs like *expect* include the following specification:

$$(54) \left[ \text{S|C|SUBCAT} \langle \text{NP}, [\text{S|C|HEAD } \textit{core}] (\text{, PP}[\textit{of}]) \rangle \right]$$

According to the SUBCAT information in (54), the verb *expect* takes three arguments: a subject NP, an object whose part of speech is specified only as *core*, and an optional PP. Given this information, and depending on the resolution of the [HEAD *core*] value, we will have the following three realizations:

- $$(55) \text{ a. } \left[ \text{S|C|SUBCAT} \langle \text{NP}, \text{NP} (\text{,PP}[\textit{of}]) \rangle \right]$$
- $$\text{ b. } \left[ \text{S|C|SUBCAT} \langle \text{NP}, \text{CP} (\text{,PP}[\textit{of}]) \rangle \right]$$
- $$\text{ c. } \left[ \text{S|C|SUBCAT} \langle \text{NP}, \text{S} (\text{,PP}[\textit{of}]) \rangle \right]$$

Let us first consider the predictions when the PP is not realized. (55a) will allow for sentences like (53a); (55b) will accommodate sentences like (53c); and (55c) will accommodate sentences like (53g). When the PP is realized, the options are more limited, as LP4 will rule out (53d) and (53h).

How then can we generate examples like (53f), whose Group I analogues are ungrammatical? These are possible with Group II verbs, since no LP rule blocks the PP-CP sequence when the PP is nonpredicative (i.e. when the PP's SUBCAT value is the empty list rather than a singleton list). As we saw earlier PP[*on*] is predicative as the complement of *blame*. PP[*of*] is different, however, as the following contrast indicates:

- $$(56) \text{ a. } \text{The blame was on me.}$$
- $$\text{ b. } * \text{The expectation is of me.}$$

There is thus no constraint barring the order instantiated by (53f). The difference in functional type of the PP interacts with other aspects of our analysis to explain this difference between Group I and Group II. Nothing rules out (53i), though it is judged somewhat less acceptable by many speakers, a fact we would explain by appeal to interacting nonsyntactic factors.

Of course a feature structure like the one in (54) can be pumped by the Extraposition Construction, just as the Group I verbs were. The result is sketched in (57):

$$(57) \left[ \begin{array}{l} \text{PHON} \langle \textit{expected} \rangle \\ \text{S|C} \left[ \begin{array}{l} \text{SUBCAT} \langle \text{NP}, \text{NP}[\textit{it}] \langle, \text{PP}[\textit{of}] \rangle \rangle \\ \text{EXTRA} \langle [\text{S|C|HEAD} \textit{verbal}] \rangle \end{array} \right] \end{array} \right]$$

This can then give rise to both (53e) and (53j). The latter type is somewhat less acceptable (*that*-less clauses prefer to be adjacent to the verb), but nonetheless occurs in spoken language data.

Verbs like *mention* and *require* also belong to this group. As noted in (58), these verbs can combine with either an NP or a CP complement:

- (58) a. They never mentioned the issue before/*that* he liked contemporary music.  
 b. They require further information/*that* the information be available soon.

Just like *expect*, the expletive NP[*it*] is also optional with these verbs:

- (59) a. They never mentioned (it) to the candidate *that* the job was poorly paid.  
 b. We require (it) of our employees *that* they wear a tie.

The present analysis predicts that when a verb selects a [HEAD *verbal*] element as its SUBCAT element, we allow sentences where nothing intervenes between the expletive *it* and the extraposed clause. Such verbs will have the SUBCAT value shown in (60) and hence can be pumped by the Extraposition Construction, as shown in (61):

$$(60) \left[ \text{S|C|SUBCAT} \langle \text{[1]NP}, \text{[2]S|C|HEAD} \textit{verbal} \rangle \right]$$

$$(61) \left[ \text{S|C} \left[ \begin{array}{l} \text{SUBCAT} \langle \text{[1]NP}, \text{NP}[\textit{it}] \rangle \\ \text{EXTRA} \langle \text{[2]HEAD} \textit{verbal} \rangle \end{array} \right] \right]$$

$$\left[ \text{S|C|SUBCAT} \langle \text{[1]NP}, \text{[2]S|C|HEAD} \textit{verbal} \rangle \right]$$



In addition, the expletive would then be optional in such cases. As shown in the following examples, such verbs can select an NP alone or else a sentential complement with an optional expletive *it*:

- (62) a. I regretted the comments/regretted (it) that he was late.  
 b. I should resent their loss of power/resented (it) that you did not call.  
 c. They suspected the gesture/suspected (it) that he was a spy.

In such examples, even when nothing separates the expletive from the clause, the clause is treated as extraposed in our analysis.<sup>11</sup>

**Group III.** Group III verbs appear not to allow object extraposition, given the unclear status of examples like (63):

- (63) a. John thought to himself that Mary was coming.  
 b. ?John thought it to himself that Mary was coming.

However, when the PP complement does not appear, we can find clear examples of object extraposition:

- (64) I thought it that it would be nearly impossible for the filmmakers to sustain such a level of excitement through the rest of the movie<sup>12</sup>

And there are also attested examples with a parenthetical that is probably best analyzed as extraposition with the PP present, e.g.:

- (65) - and I think it's great when Nessa says (or maybe she just thinks it to herself) that Eyvind, unlike Somerled, is wise.<sup>13</sup>

Note that, unlike Group II verbs, these verbs do not allow an NP, but select a VP[*inf*] or a CP clause as object:

- (66) a. \*John thought the problem.  
 b. He didn't think to find him in the kitchen.  
 c. Everyone thinks that they're going to get their lyrics.

These observations imply that such verbs have the SUBCAT information shown in (67):

- (67) 
$$\left[ \begin{array}{l} \text{PHON } \langle \text{think} \rangle \\ \text{S|C } \left[ \text{SUBCAT } \langle \text{NP}, [\text{HEAD } \textit{verbal}] (, \text{PP}[\textit{to}]) \rangle \right] \end{array} \right]$$

Group III verbs can get pumped by the Extraposition Construction, which allows our grammar to generate sentences like (64) and (65).

<sup>11</sup>Rothstein (1995) takes such cases as dislocation of the clause rather than extraposition. We believe that there are no significant differences between such cases and those with something separating the two phrases.

<sup>12</sup><http://www.peyups.com/article.khtml?sid=2504> [April 3, 2005]

<sup>13</sup><http://www.council-of-elrond.com/forums/showthread.php?t=1055> [April 15, 2005]

## 4 Some Further Consequences

The analysis sketched here first of all allows a wider coverage of true extraposition. Since the daughter of the Extraposition Construction can be any verb selecting [HEAD *verbal*], we expect not only CP, but also S complements to undergo extraposition. The corpus examples attest this:<sup>14</sup>

- (68) a. It's to debate whose scheme is best... (S1B-034-1)  
b. It's now known they took a rucksack of clothes with them. (S2B-009-43)  
c. It is anticipated a final decision will be made in the New Year. (W2C-011-96)

There is in fact evidence supporting the idea that EXTRA might be better treated as a nonlocal feature, on a par with the SLASH feature. If the percolation of SLASH specifications were governed by the Nonlocal Feature Principle, then we would expect cases like the following:

- (69) She [[[kept] [regretting it] [for years]] [that she had not turned him down]].

Here the extraposed clause and the expletive are not in the same clause: the expletive *it* is within the complement clause of the verb *kept*, suggesting that inheritance of EXTRA specifications is general, and in the fashion of nonlocal feature specifications.

Another implication of our approach is that if extraposition is dependent upon the properties of lexical heads, then we would expect certain lexical idiosyncrasies (restrictions that cannot be predicted on general syntactic grounds). In fact there are peculiar cases in which the presence of *it* is obligatory:

- (70) a. We would appreciate \*(it) (very much) if we were left alone from now on.  
b. I like \*(it) that she has good manners.  
c. Rumor had \*(it) that Spain my support the bill as well.<sup>15</sup>

These verbs select just an NP, not a CP: We thus cannot take them to be instances of the GROUP II class. Thus there is a limited set of verbs that simply allow the same subcategorization information as that produced by the Extraposition Construction:<sup>16</sup>

---

<sup>14</sup>These examples are from the ICE-GB (International Corpus of English) corpus. S1B and S2b mean spoken texts whereas W2c means written texts.

<sup>15</sup>from the BNC corpus

<sup>16</sup>Similar lexical idiosyncrasies are found with respect to passivization (e.g. *rumored*, *alleged*) and *wh*-extraction (e.g. *assure*, cf. Kayne 1981-82).

$$(71) \left[ \begin{array}{c} \text{S|C} \\ \left[ \begin{array}{l} \text{SUBCAT} \langle \text{NP}, \text{NP}[it] \rangle \\ \text{EXTRA} \langle \text{CP} \rangle \end{array} \right] \end{array} \right]$$

Our approach allows a straightforward lexical account of these lexical idiosyncrasies.

## 5 Conclusion

We have reconsidered English object extraposition sentences in light of recent attempts to defend Chomsky's Projection Principle. We have seen that there is no extant transformational analysis that offers satisfactory answers to the various properties of English object extraposition constructions discussed in the literature, including the three lexical classes we have isolated.

These verbal classes display a number of intriguing patterns with respect to object extraposition constructions, as we have shown. As a way of accounting for these patterns, we have suggested that English object extraposition is lexically modulated and that the lexical variations interact with other independently motivated constraints, some of which are particular to English, and some of which are more deeply embedded in the lexicalist, constraint-based approach to language that we assume.

## References

- Authier, J. Marc. 1991. V-Governed Expletives, Case Theory, and the Projection Principle. *Linguistic Inquiry* 22.4: 721–740.
- Bouma, Gosse. 1996. Complement clauses and expletives. In G. Durieux, W. Daelemans and S. Gillis (eds), CLIN VI. Papers from the Sixth CLIN Meeting, pp. 1-17.
- Chomsky, Noam. 1981. *Lectures on Government and Binding*. Dordrecht: Foris.
- Collins, Peter. 1994. Extraposition in English. *Functions of Language* 1.1: 7–24.
- Culicover, Peter W. and Michael S. Rochemont. 1990. Extraposition and the Complement Principle. *Linguistic Inquiry* 21.1: 23–47.
- Ginzburg, Jonathan and Ivan Sag. 2001. *Interrogative Investigations* CSLI Publications, Stanford.
- Huddleston, Rodney D. and Geoffrey K. Pullum. 2001. *The Cambridge Grammar of the English Language*. Cambridge University Press.
- Iwakura, Kunihiro. 1991. Expletive *it* and CP-Trace. *Linguistic Analysis* 21: 97–115.
- Iwakura, Kunihiro. 1994. The Distribution of CP-Trace and the Expletive *it*. *Linguistic Analysis* 24.2: 122–141.

- Jackendoff, Ray. 2002. *Foundations of Language*. Cambridge: Cambridge University Press.
- Kayne, Richard. 1981. ECP extensions. *Linguistic Inquiry* 12.1:93–133. [Reprinted in: Kayne, Richard. 1984. *Connectedness and Binary Branching*. Dordrecht: Foris Publications.]
- Keller, Frank. 1995. Towards an Account of Extraposition in HPSG. *Proceedings of the EACL*.
- Kuno, Susumo. 1987. *Functional Syntax*. Chicago: The University of Chicago Press.
- Pollard, Carl, and Ivan A. Sag. 1994. *Head-driven Phrase Structure Grammar*. Chicago University Press and CSLI Publications.
- Postal, Paul M. and Geoffrey K. Pullum. 1988. Expletive Noun Phrases in Subcategorized Positions. *Linguistic Inquiry* 19.4: 635–670.
- Postal, Paul M. 1966. On so-called ‘pronouns’ in English. In F. Dinneen, ed., *The 19th monograph on Languages and Linguistics*. Washington, D.C.: Georgetown University Press. Reprinted 1969 in D. A. Reibel & S. A. Schane (eds.) *Modern studies in English: Readings in transformational grammar*. Englewood Cliffs, NJ: Prentice-Hall. Pp. 201–224.
- Quirk, Randolph, Sidney Greenbaum, Geoffrey Leech, and Jan Svartvik. 1985. *A Comprehensive Grammar of the English Language*. London: Longman.
- Rothstein, Susan D. 1995. Pleonastics and the Interpretation of Pronouns. *Linguistic Inquiry* 26.3: 499–529.
- Sag, Ivan A. 2001. Six Dimensions of Natural Language Locality. Invited Presentation: Eighth Annual Conference on Head-Driven Phrase Structure Grammar. NTNU. Trondheim, Norway.
- Sag, Ivan A. to appear. Remarks on Locality. *Ohio State Working Papers in Linguistics*, edited by Detmar Meurers and Robert D. Levine.
- Sag, Ivan, Tom Wasow, and Emily Bender. 2003. *Syntactic Theory: A Formal Introduction*. 2nd Edition. Stanford: CSLI Publications.
- Stroik, Thomas S. 1991. Expletives Revisited *Linguistic Analysis* 21.1: 23–33.
- Stroik, Thomas S. 1996. Extraposition and Expletive-Movement: A Minimalist Account. *Lingua: International Review of General Linguistics* 99.4: 237–251.
- Van Eynde, Frank. 1996. A monostratal treatment of it extraposition without lexical rules. In G. Durieux, W. Daelemans and S. Gillis (eds), *Papers from the Sixth CLIN Meeting*, 231-248.

# Copy constructions and their interaction with the copula in Korean

Jong-Bok Kim 

Kyung Hee University

Peter Sells 

Stanford University

Proceedings of the 12th International Conference on  
Head-Driven Phrase Structure Grammar

Department of Informatics, University of Lisbon

Stefan Müller (Editor)

2005

Stanford, CA: CSLI Publications

pages 213–231

Kim, Jong-Bok & Peter Sells. 2005. Copy constructions and their interaction with the copula in Korean. In Stefan Müller (ed.), *Proceedings of the 12th International Conference on Head-Driven Phrase Structure Grammar, Department of Informatics, University of Lisbon*, 213–231. Stanford, CA: CSLI Publications. DOI: 10.21248/hpsg.2005.12. 

## Abstract

We argue here for a lexicalist analysis of the Korean copula (following Kim et al. (2004)), on the basis of different properties of sequences of noun-plus-copula, which shows word-like behavior, in contrast to noun and negative copula, which are independent syntactic units. The interactions of these items with various copy constructions brings out their clear differences. The analysis is formalized in HPSG using Lexical Sharing, from Wescoat (2002).

## 1. The Copula

The Korean copula *-i-* forms a phonological word with its preceding N host (see e.g., Oh (1991), Cho and Sells (1995)); (1)a is a representative example. The negative copula *ani-* in (1)b shows a similar structure, but without the phonological cohesion; in fact its complement (*salam*) takes nominative case.

- (1) a. ku haksayng-un ilpon-eyse o-n salam-i-ta  
that student-TOP Japan-from come-PAST person-COP-DECL  
'That student is a person from Japan.'
- b. ku haksayng-un ilpon-eyse o-n salam-i ani-ta  
that student-TOP Japan-from come-PAST person-NOM NCOP-DECL  
'That student is not a person from Japan.'

The nominative marker has allomorphs *-i* and *-ka* which are regularly conditioned.

In canonical predicative uses the copula *-i-* does not allow case-marking on the complement N, nor any other final suffix such as *-(n)un* or *-to*, as shown in (2)a. The negative copula *ani-ta*, however, does allow such suffixes, as seen in (2)b.

- (2) a. apeci-nun hakca(\*-ka/\*-nun/\*-to)-i-ta  
father-TOP scholar(\*-NOM/\*-TOP/\*-FOC)-COP-DECL  
'My father is a scholar.'
- b. apeci-nun hakca(-ka/-nun/-to) ani-ta  
father-TOP scholar(-NOM/-TOP/-FOC) NCOP-DECL  
'My father is not a scholar.'

The impossibility of final suffixes seen in (2)a suggests the lexicality of the form consisting of the noun host plus copula (see Cho and Sells (1995), Sells (1997)), for it is not clear why a clitic treatment of the copula would predict the lack of parallel in the examples in (2).

---

<sup>†</sup>This paper represents a part of joint work with Michael T. Wescoat on the application of Lexical Sharing to Korean and Japanese. We are particularly grateful to Michael, and also to Ivan Sag, for discussions on the best formalization of Lexical Sharing within HPSG. Our paper has also benefitted from comments from the audience at HPSG05.

On the other hand, the modifier *ilpon-eyse o-n* in (1) forms a constituent with the head noun *salam*, showing evidence of an NP in the syntax. This observations seems most consistent with the view of the copula *-i-* as a clitic (the most thorough treatment is in Yoon (2003)). Specifically, the copula is treated as a V in syntax that forms a phonological word with its adjacent N host, the head of an NP complement, indicated by the '=' in (3). The negative copula has the same syntax but just happens not to be a clitic (hence the examples in (1) are syntactically parallel):

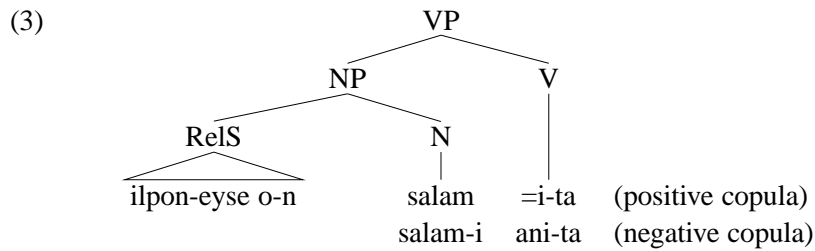

In this paper we add to a growing body of evidence which shows that noun plus copula is indeed a lexically-formed verb (see especially Kim et al. (2004)), despite the apparent evidence in favor of a clitic analysis. A fully lexical account can nevertheless allow that the N which hosts the copula can head a fully-formed syntactic NP (in (1)b), through the adoption of the Lexical Sharing approach of Wescoat (2002). Informally, Lexical Sharing allows words to instantiate *one or more* lexical-category nodes, and so, alongside familiar one-word-to-one-phrase instantiation, exemplified by *salam-i* ‘person-NOM’, the theory also posits *port-manteau* words, which instantiate two or more adjacent lexical-category nodes. This allows us to accept the lexicality of *salam-i-* ‘person-COP’, a form which may receive verbal inflectional affixation in the lexicon (see Kim et al. (2004)). We will adopt the syntactic structure for the positive copula in (3) while nevertheless treating the host noun plus copula as a single word.

Our evidence for lexicality involves the careful separation of several related ‘copying’ constructions in Korean, which provide evidence for lexical and syntactic units. In section 2 we briefly describe the first three of these constructions; then, in section 3, we introduce examples involving noun plus copula, and some of these involve a fourth construction. In section 4 we present the HPSG analysis which accounts for the data given in sections 2 and 3, with the exception of the specific analysis of the copula in terms of lexical sharing, which is given in section 5.

## 2. Evidence from the Echo Construction

Our new evidence regarding the status of the copula comes from the subtle contrasts that we can find between apparently similar examples involving copying various amounts of syntactic material. In all, we introduce 4 constructions in this paper, listed in (4); the remainder of this section is focussed on the first three types.

- (4) Constructions introduced in this paper
- a. Echo Contrastive Construction (ECC): *V-ki-nun V-ta*, sets up a negative implicature.
  - b. *Ha* Contrastive Construction (HCC): *V-ki-nun ha-ta*, sets up a negative implicature.
  - c. VP-Topic Construction: *VP-ki-nun VP-ta*, has no negative implicature.
  - d. Noun Copy Construction (NCC): *N-nun N*, indicates that N is a prototypical member of its class.

The first construction, ‘Echo Contrastive Construction (ECC)’, involves the doubling of Vs, but does not extend to their phrasal arguments or adjuncts.<sup>1</sup> As shown in the translation of (5)a, the ECC sets up a negative implicature in the interpretation of the whole sentence (see Choi (2003), Cho et al. (2004), Kim (2002), Aoyagi (2005)). This negative implicature is indicated by the ‘*but . . .*’ in our translations.

(5)b shows a related construction, the ‘*Ha* Contrastive Construction (HCC)’, which involves using the verb *ha* (‘do’) for the second verb, rather than a copy of the first, but which also has the negative implicature.

- (5) a. ECC: copy the verb root; inflect the second verb for tense etc.

John-i Tom-ul [manna-ki-nun manna-ss-ta]  
 John-NOM Tom-ACC meet-NMLZ-TOP meet-PAST-DECL  
 ‘John met Tom, but . . . .’

- b. HCC: follow the verb root with a form of *ha*; inflect the second verb (*ha*) for tense etc.

John-i Tom-ul [manna-ki-nun hay-ss-ta]  
 John-NOM Tom-ACC meet-NMLZ-TOP do-PAST-DECL  
 ‘John met Tom, but . . . .’

The interaction of the ECC with the copula provides strong support for our claim about the lexicality of the copula. The only grammatical form of an ECC with the positive copula *-i-* also involves doubling the N host of the copula, as in (6)a (see Oh (1991), Kim and Chung (2002)). The copied parts are underlined.

<sup>1</sup>Strictly speaking, the ECC can copy a  $V^0$  which may itself be internally complex, consisting of more than one word, but it may not contain phrasal material (see Cho et al. (2004); and (18) below).

The label ‘predicate cleft’ has been applied to the ECC, for example by Nishiyama and Cho (1998) and Jo (2004b). The term comes from Koopman (1984), who describes a construction in Vata which has a copy of the verb in initial position in the clause, followed by a full clause (which is SOV). We do not think that the Korean constructions that we discuss here have the same properties, either in terms of syntax or interpretation.



- (6) a. ku salam-i [mikwuk-eyse kongpwu ha-n]  
 that person-NOM America-at study do-PAST  
haksayng-i-ki-nun haksayng-i-ta  
 student-COP-NMLZ-TOP student-COP-DECL  
 ‘That person is a student who studied in America (but he still doesn’t speak English well).’
- b. \*ku salam-i [mikwuk-eyse kongpwu ha-n]  
 that person-NOM America-at study do-PAST  
 haksayng-i-ki-nun i-ta  
 student-COP-NMLZ-TOP COP-DECL  
 (copying ‘V’ only; ungrammatical)

Copying the copula alone is completely impossible, as in (6)b. Now under the clitic analysis, the copula never forms a syntactic unit with its NP complement, and so we would expect (6)b to be the grammatical version. Additionally, it is unclear how to make the copied part in (6)a a syntactic constituent – formally, it would correspond to the head of the complement NP and the following V (which selects for that NP). However, we see clearly that the ECC treats N+Copula as a lexical constituent, and that the copula alone cannot function as a pure V in the syntax, from the contrast in (6)a and (6)b.

The facts in (6) contrast directly with the ECC facts involving the negative copula *ani-*, which takes a nominative-marked complement (see (1)b): the *ani-* verbal part can be doubled by itself, as in (7)b, just like a regular verb (cf. (5)a). And while the doubling of N + negative copula as in (7)a is grammatical, this example does not have the ‘negative implicature’ interpretation typical of the ECC, but rather has a VP-topic interpretation – along the lines of ‘as for not being a fool, that person is not a fool’.<sup>2</sup> This asymmetry shows that the ECC targets a verb in the syntax and intuitively copies it, meaning that there is a lexical form *haksayng-i-* for (6)a alongside *ani-* for (7)b. The positive copula is in fact one of a class of verbal elements including *-tap-* ‘is every bit’ and *-kath-* ‘seem’ (noted by Yoon (2003)), which behave in the same way, including in the ECC.

- (7) a. ku salam-i papo-ka ani-ki-nun papo-ka ani-ta  
 that person-NOM fool-NOM NCOP-NMLZ-TOP fool-NOM NCOP-DECL  
 ‘It is true that that person is not a fool.’ (VP-topic)
- b. ku salam-i papo-ka ani-ki-nun ani-ta  
 that person-NOM fool-NOM NCOP-NMLZ-TOP NCOP-DECL  
 ‘That person is not a fool (but he is not so smart).’ (ECC)

---

<sup>2</sup>The facts are subtle because prosodic prominence on the marker *-nun* can also trigger a negative implicature due to its contrastive properties, but we believe that speakers can have clear intuitions about ECC vs. VP-Topic constructions.

Although the details will come later, the structure we assign to (6)a is given in (8), where the two sister V nodes over to the right constitute the ECC. The upward arrows are explained in section 5.

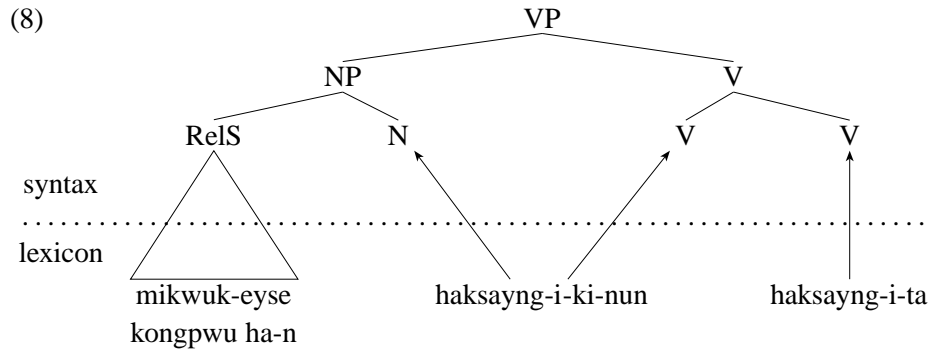

As is clear from (8), the combination of noun+copula is a lexical unit – it is a single item in the lexicon.

### 3. Noun Copying and Verb Copying

Now we introduce the fourth construction mentioned in (4). Jo (2004a,2004b) discusses pairs of examples apparently involving the ECC and the copula, based on the simple example in (9)a:

- (9) a. chelswu-ka pwuca-i-ess-e  
 chelswu-NOM rich-COP-PAST-DECL  
 ‘Chelswu was rich (a rich man).’
- b. chelswu-ka pwuca-nun pwuca-i-ess-e  
 chelswu-NOM rich-TOP rich-COP-PAST-DECL
- c. chelswu-ka pwuca-i-ki-nun pwuca-i-ess-e  
 chelswu-NOM rich-COP-NMLZ-TOP rich-COP-PAST-DECL

Jo argues that the relation between (9)b and (9)c shows that what is copied is either the N before the copula, for (9)b, or a larger constituent consisting of N and the copula, for (9)c, both coming from the same source in a transformational derivation involving the ‘copy theory’ of movement.<sup>3</sup>

There are several pieces of evidence which show that although (9)c is indeed an instance of the ECC, (9)b is not. Rather, (9)b is an ‘N-Copy Construction’ (which we will call ‘NCC’), which reinforces the meaning of the N, and we translate it

<sup>3</sup>Strictly, Jo argues that a sequence of the subject plus some part of the predicate is copied, with the subject deleted in the second copy (Jo, 2004b, 172ff.).

roughly as ‘truly’.<sup>4</sup> In other words, (9)b involves N copying, while (9)c involves V copying, as the underlining above suggests.

As mentioned above, the pragmatic hallmark of the ECC is that it sets up a negative implicature, without any assistance from other morphemes in the clause which may have adversitive or concessive meanings. This distinguishes (9)b from (9)c, and identifies only c as the ECC. While they both involve copying constructions (which will be related, but not identical, in our analysis), the key difference is that (9)b involves copying Ns, while (9)c involves copying Vs, and only the latter type has the negative implicature.

One clear difference between the two constructions can be observed from the alternation with the HCC. With noun and copula, the ECC alternates with the HCC (see (5)b), while the NCC does not:

(10) NCC does not alternate with HCC; ECC does alternate with HCC:

- a. chelswu-ka pwuca-nun pwuca-i-ess-e (NCC)  
chelswu-NOM rich-TOP rich-COP-PAST-DECL  
‘Chelswu is a truly rich man.’
- b. \*chelswu-ka pwuca-nun hay-ss-e (\*HCC)  
chelswu-NOM rich-TOP do-PAST-DECL  
‘Chelswu is a truly rich man.’
- c. chelswu-ka pwuca-i-ki-nun pwuca-i-ess-e (ECC)  
chelswu-NOM rich-COP-NMLZ-TOP rich-COP-PAST-DECL  
‘Chelswu is a rich man, but . . . .’
- d. chelswu-ka pwuca-i-ki-nun hay-ss-e (HCC)  
chelswu-NOM rich-COP-NMLZ-TOP do-PAST-DECL  
‘Chelswu is a rich man, but . . . .’

The HCC is clearly a V-V complex predicate, so its failure to work with a purely nominal first part as in (10)b is expected.

Next, the interaction with the negative copula is once again telling. From the simple example in (11)a, we might expect the following alternatives to be acceptable, which involve (respectively) copying the verb, copying the noun and verb, or just copying the noun:

(11) ECC can be negated; NCC can not:

- a. chelswu-ka pwuca-ka ani-ta  
chelswu-NOM rich-NOM NCOP-DECL  
‘Chelswu is not a rich man.’

---

<sup>4</sup>The ‘prototypical’ nature of the interpretation is also discussed for a copying construction in English by Ghomeshi et al. (2004), a construction they term ‘contrastive focus reduplication’. They propose that the semantics of reduplication in English involves contrastive focus along the dimension of “PROTOTYPICAL/EXTREME/SALIENT”.

- b. chelswu-ka pwuca-ka ani-ki-nun ani-ta (negative ECC)  
 chelswu-NOM rich-NOM NCOP-NMLZ-TOP NCOP-DECL  
 ‘Chelswu is not a rich man (but he is very generous).’
- c. chelswu-ka pwuca-ka ani-ki-nun  
 chelswu-NOM rich-NOM NCOP-NMLZ-TOP  
pwuca-ka ani-ta (negative VP-topic)  
 rich-NOM NCOP-DECL  
 ‘As for not being rich, Chelswu is not rich.’
- d. \*chelswu-ka pwuca-nun pwuca-ka ani-ta (negative NCC)  
 chelswu-NOM rich-TOP rich-NOM NCOP-DECL  
 (int.) ‘Chelswu is truly (not) rich.’

However, the last example is unacceptable, showing that while the ECC sets up a negative implicature, the NCC involves N copying and reinforces the positive property of the N. This explains why (11)d is strange – the N-copy part sets up a strong positive assertion, but then the verb negates it. Each example in (11)b–d has a different kind of interpretation, which shows that they cannot come from a common source.

Further differences exist between the ECC and the NCC. Delimiters like *-man* (‘only’) can be used as the marker on the first verb in the ECC but not in the NCC, as seen in (12):<sup>5</sup>

- (12) ECC allows delimiters on the first predicate other than *-nun*; NCC does not:
- a. chelswu-ka pwuca-i-ki-nun/man pwuca-ya (ECC)  
 Chelswu-NOM rich-COP-NMLZ-TOP/only rich-DECL  
 ‘Chelswu is rich/only rich, but . . . ’
- b. chelswu-ka pwuca-nun/\*man pwuca-ya (NCC)  
 Chelswu-NOM rich-TOP/only rich-DECL  
 ‘Chelswu is truly (\*only) rich.’

Finally, a proper noun cannot occur in the NCC at all:

- (13) The predicate in the ECC can be a proper name, but not in the NCC:
- a. ku salam-i John-i-ki-nun John-i-ya (ECC)  
 that person-NOM John-COP-NMLZ-TOP John-COP-DECL  
 ‘That person is John, but . . . ’
- b. ?\*ku salam-i John-un John-i-ya (NCC)  
 that person-NOM John-TOP John-COP-DECL  
 ‘That person is truly John.’

<sup>5</sup>The copula *-i-* in (12)a is phonologically elided due to the following high [y].

In summary, there are many differences between copying a noun (in the NCC) and copying a noun+copula unit (in the ECC), indicating two separate but related constructions. The noun+copula unit behaves like a verb, as predicted by the lexical analysis of the copula, but not by the clitic analysis.

#### 4. Analysis of the Constructions

In this section we present our analysis of ECC, HCC and NCC constructions discussed above, with the exception of the Lexical Sharing analysis of the copula, which is given in the following section.

In the constructional approach, constructions are generalized types which express partial information that a surface configuration may inherit from. The structures that we need to account for are given in (14)–(16).

(14) ECC/HCC

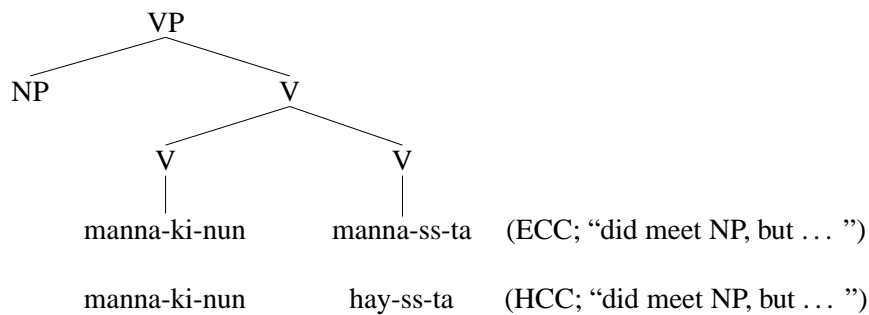

The ECC involves copying a verb stem (*manna-* ‘meet’) in this example, while the HCC presents the content verb as complement to *ha-*. As far as syntactic structure is concerned, the constructions are identical.

Now if the verb in the ECC is a copularized noun, we have the structure in (15), presupposing the lexical sharing analysis to follow:

(15) ECC with copula

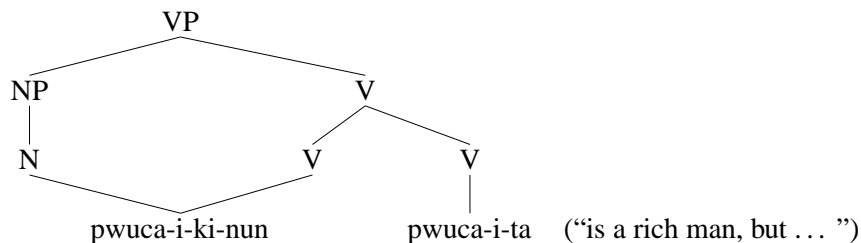

As this is the ECC, it is the V node which is intuitively copied; it just happens that the first V participates in lexical sharing with a preceding N, which heads an NP. The regular principles of ordering place the NP in front of its sister V, and

by the Homomorphic Lexical Integrity property of the Lexical Sharing theory (see Wescoat (2002)), the N head of NP must (immediately) precede the left V copy. Informally, Lexical Sharing does not allow tangled trees, and so two nodes which share the same lexical item must be adjacent pre-terminals in the structure.

The structure in (15) contrasts with the NCC in (16), in which it is the N which is copied, and the second copy is lexically shared with a single V node:

(16) NCC with copula

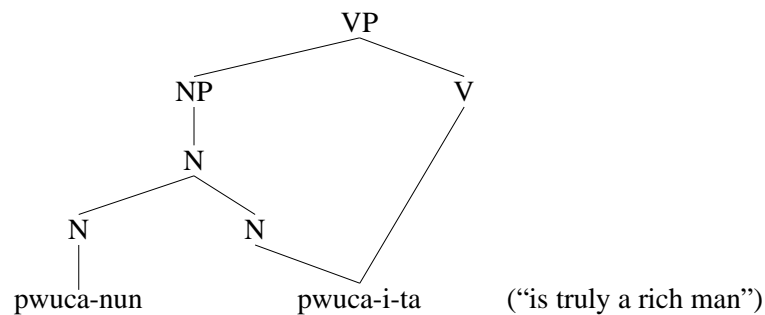

Intuitively, the ECC and NCC involve copying the V or N stem, a stem which may be subject to further affixation (such that the non-stem parts of the two copies differ in form). We will adopt an approach here which copies on the basis of fine-grained semantic similarity, rather than surface phonological form, using Minimal Recursion Semantics (MRS). To begin, the semantics of the inflected verb *ilk-ess-ta* (‘read-PAST-DECL’) is as follows:

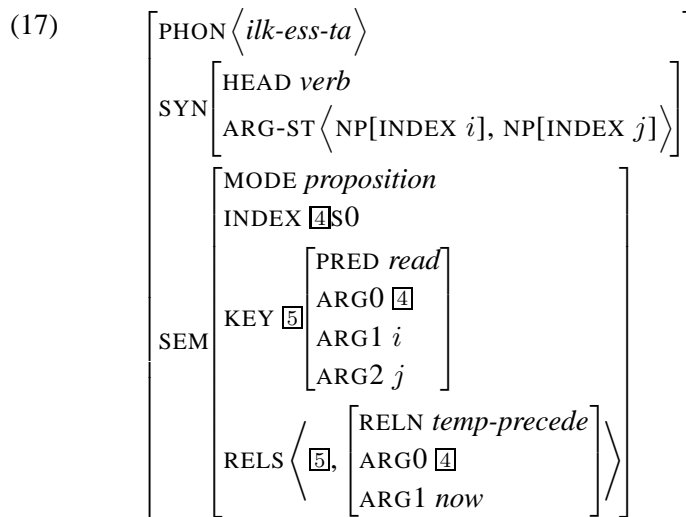

The semantics is stated as a list of *relations*, one of which is picked out as the KEY, and this will be the basis of the copying. The MODE feature represents the semantic mode of the expression such as *proposition*, *question*, *directive*, expressed by

the final MOOD marker in Korean. The preceding past tense marker *-ess-* provides the information in the second element in the RELS list. The information associated with the KEY comes directly from the lexical root, the V-root *ilk-* in (17).

We can now state the copy construction in (18), which forms copies based on the KEY in the MRS semantic form:

(18) *copy-cx*:

$$\left[ \begin{array}{l} \phantom{SEM | KEY} \\ \phantom{BAR 0} \end{array} \right] \rightarrow \left[ \begin{array}{l} \text{SEM | KEY } \boxed{\mathbb{1}} \\ \text{BAR 0} \end{array} \right], \mathbf{H} \left[ \begin{array}{l} \text{SEM | KEY } \boxed{\mathbb{1}} \\ \text{BAR 0} \end{array} \right]$$

The specification of [BAR 0] allows for the presence of a restricted kind of adverbial in the copies; such adverbials are  $X^0$ s which are themselves modifiers of  $V^0$  (see Sells (1998)). An identical adverbial must appear before each verb, so (19)b is unacceptable, contrasting with (19)a; and both verbs must match too, as (19)c shows.

- (19) a. John-i Tom-ul cacwu manna-ki-nun cacwu manna-ss-ta  
 John-NOM Tom-ACC often meet-NMLZ-TOP often meet-PAST-DECL  
 ‘John often met Tom, but . . . .’
- b. \*John-i Tom-ul cacwu manna-ki-nun congcong manna-ss-ta  
 John-NOM Tom-ACC often meet-NMLZ-TOP often meet-PAST-DECL
- c. \*John-i sinmwun-ul cacwu sa-ki-nun  
 John-NOM newspaper-ACC often buy-NMLZ-TOP  
cacwu ilk-ess-ta  
 often read-PAST-DECL  
 ‘John often bought/read a newspaper, but . . . .’

Our proposal in terms of the KEY predicts these facts. In (19) the KEY will be the semantics of the adverbial ‘often’ which will directly take the verb’s *relation* as its argument. Only in (19)a do the KEY values fully match as (18) specifies.

The ECC inherits from (18) and from a semantic constraint setting up a contrastive focus, and hence a negative implicature, given in (23) below. The NCC also inherits from (19) and from a semantic constraint expressing a reinforced positive assertion of the property denoted by the copied N (in (24) below).

With regard to the precise form of the copies, the first copy in the NCC is marked with *-nun*, while a verb in the ECC is first nominalized with *-ki* (which we treat via a FORM feature – see (23) below) before hosting *-nun*, or some other particle (the variation is shown in the examples in (12) above). We do not attempt to present a full account of the morphology in this paper (further details are given in Cho et al. (2004)).

The HCC is a complex predicate, a type of *hd-word-ph(rase)*, in which a head selects a complement:

(20) *hd-word-ph*:

$$[\text{BAR } 0] \rightarrow \boxed{[\text{BAR } 0]}, \mathbf{H} \left[ \begin{array}{l} \text{BAR } 0 \\ \text{COMPS } \langle \dots, \boxed{[(\text{FORM } \mu)]}, \dots \rangle \end{array} \right]$$

This general type of combination lets one  $X^0$  select for another  $X^0$  (including an optional FORM specification  $\mu$  on the selectee), creating a new  $X^0$ . Complex predicates in Korean involve possibly recursive combinations of  $X^0$  elements (see Sells (1998)).

Finally, any verbal complex predicate inherits from the type *hd-word-ph*, and every verb-headed phrase from *verb-headed-ph*:

(21) *verb-headed-ph*:

$$[ ] \rightarrow \dots \mathbf{H} \left[ \begin{array}{l} \textit{verb} \\ \text{BAR } 0 \\ \text{TENSE } \textit{value} \\ \text{MOOD } \textit{value} \end{array} \right]$$

This type requires that a lexical head should be specified for a value for TENSE and MOOD features, as appropriate for the type *verb*.<sup>6</sup>

Given that the HCC is a type of complex predicate, we need not assume any other constraints on the type of *hcc-ph* other than the lexical constraints on the auxiliary verb *ha-*, and the information inherited from *contrast-hd-ph*, which the ECC also inherits from. It is well-known that an initial *-(n)un*-marked phrase in Korean marks a Topic in the simplest sense, while sentence-internal *-(n)un* marks a contrastive phrase of some kind. Following Vallduví and Vilkuna (1998), we assume that any phrase may be specified as Topic and Focus and also may be independently specified as Contrastive (or not). As it is marked with *-(n)un* or some other suitable delimiter, and may also bear a phonological accent, it is the content verb in a copy construction which receives a Contrastive interpretation. Lee (2000) has argued that the negative implicature arises from a constructional meaning of ‘Contrastive Topic’. We take the meaning of Contrastive Topic to be as summarized informally in (22):

(22) Contrastive Topic: The proposition is asserted, and that assertion implicates that there is at least one alternative proposition which is either false or whose truth value is not known (based on Oshima (2002)).

We then represent *contrast-hd-ph* as follows:

(23) *contrast-hd-ph*:

$$[ ] \rightarrow \left[ \begin{array}{l} \text{PRED } \textit{contrast-topic} \\ \text{ARG0 } s\emptyset \end{array} \right], \mathbf{H} [ ]$$

<sup>6</sup>Korean verbs are also specified as honorific (usually with the suffix *-(u)si-*) or non-honorific (unmarked); for simplicity, we omit consideration of honorification here.



This constraint specifies the construction *contrast-hd-ph* has a Contrastive Topic interpretation applied to the situation index of the predication of the head verb.

The contribution of ‘reinforcement of prototype’ (see footnote 4) for the NCC is likewise specified in (24):

(24) *reinforce-hd-ph*:

$$\left[ \text{SEM} \left[ \text{RELS} \left\langle \dots, \left[ \text{PRED } \textit{prototypical} \right], \dots \right\rangle \right] \right] \rightarrow \\ \text{[INDEX } \square \textit{indiv}] , \mathbf{H}[\text{INDEX } \square \textit{indiv}]$$

In sum, the surface constructions that we have discussed here inherit as follows, which graphically illustrates the commonalities:

(25) *ecc-ph*: *copy-cx*  $\wedge$  *contrast-hd-ph*  $\wedge$  *vb-headed-ph*  
*hcc-ph*: *contrast-hd-ph*  $\wedge$  *vb-headed-ph*  $\wedge$  *hd-word-ph*  
*ncc-ph*: *copy-cx*  $\wedge$  *reinforce-hd-ph*

## 5. Lexical Sharing Analysis

### 5.1. Lexical Sharing in HPSG

Wescoat (2002) argues that the atomic units of phrase structure are neither words, as claimed by Di Sciullo and Williams (1987), nor morphemes, as assumed in Autolexical Syntax (see Sadock (1991)), but rather lexical-category-bearing *atomic constituents*, each of which maps to a word, which *instantiates* the atomic constituent. The basic idea of lexical sharing is then that a single word may instantiate multiple atomic constituents. This scheme provides a straightforward model of words that appear to straddle a phrase boundary. Lexical sharing may be implemented using the basic machinery of HPSG, in which there is a basic sort of *sign*. Two subtypes of *sign*, namely *phrase* and *word*, have been traditionally employed for representing phrase-structure constituents; thus, standard HPSG is among those theories that regard words as the atoms of phrase structure. In the lexical sharing approach we divorce the type *word* from this role, and have a new, properly syntactic type to represent atomic constituents in phrase-structure, namely *atom*. The modified *sign* hierarchy is shown in (26).

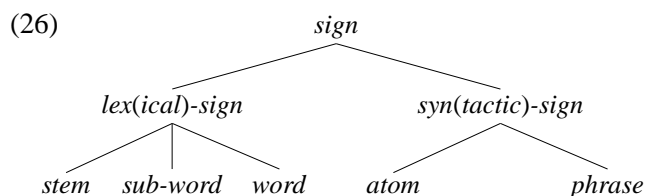

The type of an AVM determines what features and what types of values the AVM may contain. The principal new type declarations are given in (27).

- (27) a. 
$$\left[ \begin{array}{l} \textit{lex-sign} \\ \text{PHON(OLGY)} \textit{ phon} \\ \text{INST(ANTIATE)S} \textit{ nelist(synsem)} \end{array} \right]$$
- b. 
$$\left[ \begin{array}{l} \textit{syn-sign} \\ \text{YIELD} \textit{ nelist(phon)} \\ \text{SYNSEM} \textit{ synsem} \end{array} \right]$$
- c. 
$$\left[ \begin{array}{l} \textit{atom} \\ \text{ARG-ST} \textit{ list(synsem)} \\ \text{YIELD} \langle [ ] \rangle \end{array} \right]$$
- d. 
$$\left[ \begin{array}{l} \textit{phrase} \\ \text{D(AUGH)T(E)RS} \textit{ nelist(syn-sign)} \end{array} \right]$$

The basic intuition is that the *word* is the exponent of the syntactic *atom*. Hence, in the declarations above, on the one hand, a lexical sign has a PHON value, like a word, and on the other hand it instantiates the SYNSEM of an *atom*, which is a syntactic sign. An atom is one type of syntactic sign, and every syntactic sign has a YIELD feature, whose value is a list of PHON values. The difference between PHON and YIELD is explained more below. For an atom, the YIELD list is of length one; for a phrase, the list of PHON values in YIELD will represent the order of constituents.<sup>7</sup>

The feature INSTS in (27)a implements lexical sharing: every *word* contains, as the value of INSTS, an ordered list enumerating each *atom* that the *word* instantiates (see (28)). The PHON value of the word becomes a member of the list value of the atom's YIELD by the following constraint. In the normal case, when there is no actual lexical 'sharing', the INSTS list is simply of length one.

(28)

$$\textit{word} \Rightarrow \left[ \begin{array}{l} \text{INSTS} \langle \left[ \begin{array}{l} \textit{atom} \\ \text{SYNSEM} \text{ [1]} \\ \text{YIELD} \langle \text{[3]} \rangle \end{array} \right], \dots, \left( \left[ \begin{array}{l} \textit{atom} \\ \text{SYNSEM} \text{ [2]} \\ \text{YIELD} \langle \text{[3]} \rangle \end{array} \right] \right) \rangle \\ \text{PHON} \text{ [3]} \end{array} \right]$$

<sup>7</sup>The feature YIELD is different from the feature DOMAIN in several respects. For example, while the mother's DOMAIN value is the concatenation of the daughter's DOMAIN values, the mother's YIELD value is the realization of the PHON value(s). See Kathol (2000) for detailed discussion of the DOMAIN feature.

This says that each word has a PHON value and it instantiates some number of atoms, each of which has the word's PHON value as its YIELD.

The effect of (28) is illustrated by the schematization in (29) of an instance of lexical sharing (the form *haksayng-i*):

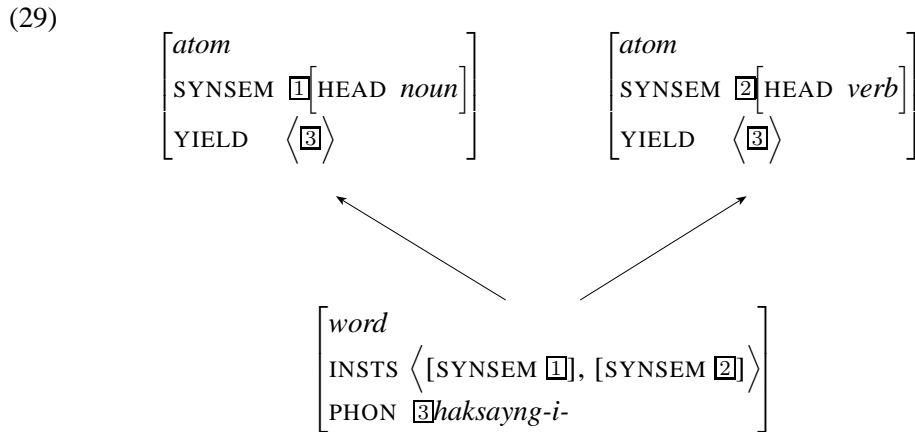

Let us compare (29) with (8), repeated here; we can see that (29) correctly captures the lexical sharing for the word *haksayng-i-ki-nun*. The last word *haksayng-i-ta* just instantiates one atom, as we describe below.

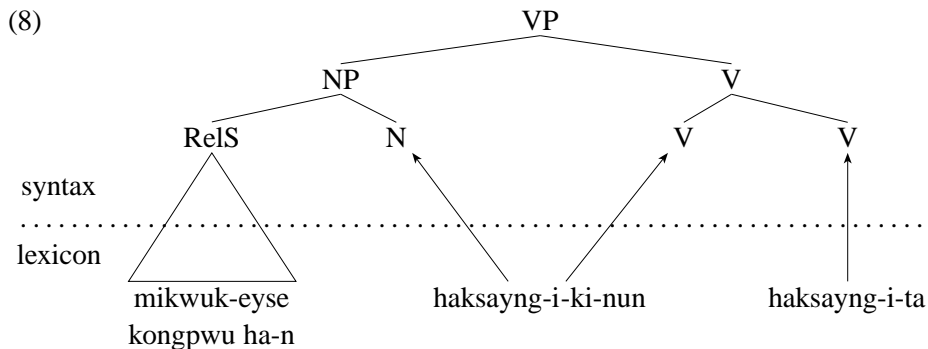

To complete the implementation of lexical sharing, the new list-valued feature YIELD is strictly speaking not just the concatenation of the elements on a list, but it is the *uniq* of a list. We state *uniq* as a constraint on the type *phrase*:

(30)

$$phrase \Rightarrow \left[ \begin{array}{l} \text{YIELD } uniq(\boxed{1} \oplus, \dots, \oplus \boxed{n}) \\ \text{DTRS } \langle [\text{YIELD} \boxed{1}], \dots, [\text{YIELD} \boxed{n}] \rangle \end{array} \right]$$

*uniq* is a function on lists, which contracts a list to a list of unique members, by removing the second of two adjacent identical occurrences of member  $\mu$ . If there are two identical occurrences of member  $\mu$  which are non-adjacent, *uniq* is undefined. In the case of lexical sharing, a word whose PHON value is  $\boxed{3}$  (cf. (29)) will participate in a structure where *uniq* applies to lists of  $\langle \boxed{2}, \boxed{3} \rangle$  and  $\langle \boxed{3}, \boxed{4} \rangle$ :

(31)

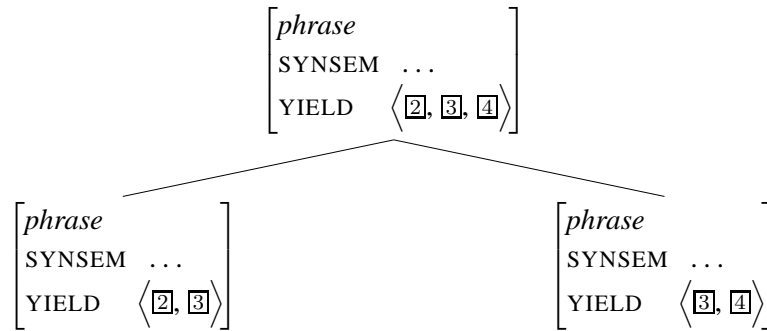

The yield of the phrase is  $\langle \boxed{2}, \boxed{3}, \boxed{4} \rangle$  and not  $\langle \boxed{2}, \boxed{3}, \boxed{3}, \boxed{4} \rangle$ .

## 5.2. The Copula

Finally, we come to the analysis of the copula itself, which will be easier to see if we start with the negative copula first. The entry for this form is shown in (32) (we assume a sort *verb-root* for the basic representation of verb roots in Korean):

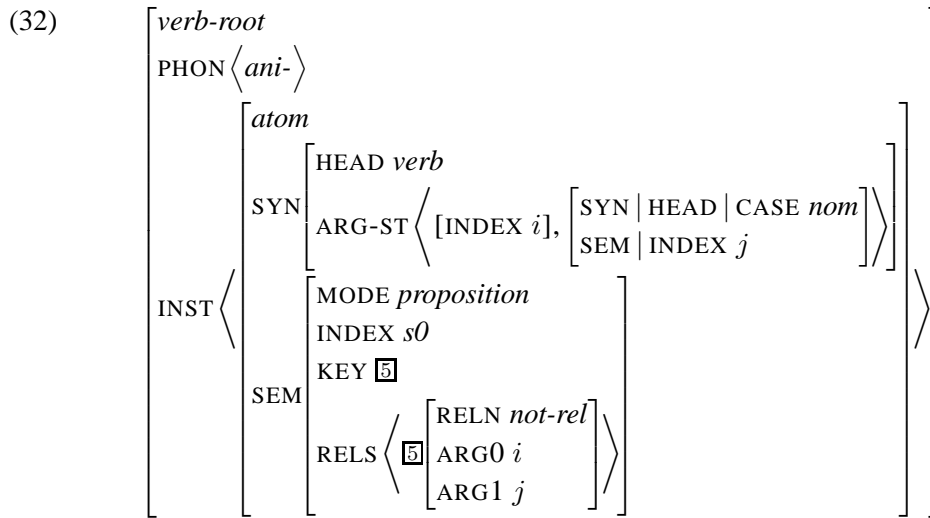

This root will be the basis of a word which instantiate a verb atom, which itself selects for two NPs, the second of which is specified to be in the nominative case.

Unlike the negative copula, the positive copula *-i-* does not exist as a root itself; it is intuitively an affix. We provide a lexical rule which takes a noun *sub-word* as input, and returns a *verb-root*. This new lexical form instantiates two syntactic atoms, as shown in (32):

(33) Copularization:

$$\left[ \begin{array}{l} \textit{sub-word} \\ \text{INSTS} \left\langle \left[ \begin{array}{l} \text{SYNSEM} \boxed{1} \left[ \begin{array}{l} \text{CAT | HEAD } \textit{noun} \\ \text{ARG-ST} \langle \boxed{7} \rangle \end{array} \right] \right] \right\rangle \\ \text{YIELD} \langle \boxed{2} \rangle \\ \text{PHON} \boxed{2} \end{array} \right] \rightarrow \\ \left[ \begin{array}{l} \textit{verb-root} \\ \text{INSTS} \left\langle \left( \left[ \begin{array}{l} \text{SYNSEM} \boxed{1} \\ \text{YIELD} \langle \boxed{2} \rangle \end{array} \right] \right), \left[ \begin{array}{l} \text{SYNSEM} \left[ \begin{array}{l} \text{CAT | HEAD } \textit{verb} \\ \text{ARG-ST} \langle \boxed{7}, \boxed{1} \rangle \end{array} \right] \right] \\ \text{YIELD} \langle \boxed{2} \rangle \end{array} \right\rangle \\ \text{PHON} \boxed{2} + i \end{array} \right]
 \end{array}$$

The output form instantiates two atoms in the syntax, an N (which heads NP) and a V (which heads VP), and may be input to further lexical rules and inflection. Hence, this is appropriate for the form *haksayng-i-ki-nun* in (8). The lexical rule puts the relevant syntax and semantics of the host N as information about the second argument of the V that the output form instantiates. Nevertheless, this is still a two-place V, an atom which will eventually combine in syntax with a complement NP and with a subject NP (3). The parenthesis in the rule around the first element on the INSTS list allows the word created by positive copularization to optionally instantiate one just one atom in syntax, a V, as for *haksayng-i-ta* at the end of (8).

## 6. Conclusion

The facts from the ECC show that noun plus copula is a lexical unit in Korean; they also show that the copula itself has no independent status as a verb. We presented an overview of the ECC and some related constructions, in particular the noun-copying NCC, which has different semantics from the ECC. Finally, to deal with the fact that noun plus copula is one lexical unit, but corresponds to both an N node and a V node in syntax, we adopted the Lexical Sharing approach of Wescoat (2002) within HPSG.

## References

- Aoyagi, Hiroshi. 2005. On Predicate Focus Constructions in Korean and Japanese. In S. Kuno et al. (ed.), *Harvard Studies in Korean Linguistics*, volume 11, Harvard University: Dept. of Linguistics, to appear.

- Cho, Sae-Youn, Kim, Jong-Bok and Sells, Peter. 2004. Contrastive Verb Constructions in Korean. In S. Kuno et al. (ed.), *Harvard Studies in Korean Linguistics*, volume 10, pages 360–371, Harvard University: Dept. of Linguistics.
- Cho, Young-mee Yu and Sells, Peter. 1995. A Lexical Account of Inflectional Suffixes in Korean. *Journal of East Asian Linguistics* 4, 119–174.
- Choi, Kiyong. 2003. The Echoed Verb Construction in Korean: Evidence for V-raising. In Patricia M. Clancy (ed.), *Japanese/Korean Linguistics*, volume 11, pages 457–470, CSLI, Stanford Linguistics Association.
- Di Sciullo, Anna-Maria and Williams, Edwin. 1987. *On the Definition of Word*. Cambridge: MIT Press.
- Ghameshi, Jila, Jackendoff, Ray, Rosen, Nicole and Russell, Kevin. 2004. Contrastive Focus Reduplication in English (The Salad-Salad Paper). *Natural Language and Linguistic Theory* 22, 307–357.
- Jo, Jung-Min. 2004a. Variation in Predicate Cleft Constructions in Korean: Epiphenomena at the Syntax-PF Interface. In S. Kuno et al. (ed.), *Harvard Studies in Korean Linguistics*, volume 10, pages 424–437, Harvard University: Dept. of Linguistics.
- Jo, Jung-Min. 2004b. *Grammatical Effects of Topic and Focus Information*. Ph.D.thesis, University of Illinois at Urbana-Champaign.
- Kathol, Andreas. 2000. *Linear Syntax*. New York: Oxford University Press.
- Kim, Jong-Bok and Chung, Chan. 2002. Korean Copula Constructions: A Construction and Linearization Perspective. *Enl* 27, 171–193.
- Kim, Jong-Bok, Sells, Peter and Wescoat, Michael T. 2004. Korean Copular Constructions: A Lexical Sharing Approach. In M. E. Hudson, S.-A. Jun and P. Sells (eds.), *Japanese/Korean Linguistics*, volume 13, CSLI, Stanford Linguistics Association, to appear.
- Kim, Youngsun. 2002. The Syntax of Korean Verbal Focus Constructions. In *Proceedings of the 2002 LSK International Summer Conference*, pages 333–344, The Linguistic Society of Korea.
- Koopman, Hilda. 1984. *The Syntax of Verbs*. Dordrecht: Foris Publications.
- Lee, Chungmin. 2000. Contrastive Predicates and Conventional Scales. In A. Okrent and J. Bolye (eds.), *CLS*, volume 36, pages 243–257, Chicago.
- Nishiyama, Kunio and Cho, Eun. 1998. Predicate Cleft Constructions in Japanese and Korean: The Role of Dummy Verbs in TP/VP-preposing. In Noriko Akatsuka et al. (ed.), *Japanese/Korean Linguistics*, volume 7, pages 463–479, CSLI, Stanford Linguistics Association.

- Oh, Mira. 1991. The Korean Copula and Palatalization. *Language Research* 27, 701–724.
- Oshima, David Y. 2002. Contrastive Topic As A Paradigmatic Operator. Ms. Stanford University (available at <http://www.stanford.edu/~davidyo>).
- Sadock, Jerrold M. 1991. *Autolexical Syntax: A Theory of Parallel Grammatical Representations*. Chicago: University of Chicago Press.
- Sells, Peter. 1997. Positional Constraints and Faithfulness in Morphology. In S. Kuno et al. (ed.), *Harvard Studies in Korean Linguistics*, volume 7, pages 488–503, Dept. of Linguistics, Harvard University.
- Sells, Peter. 1998. Structural Relationships Within Complex Predicates. In Byung-Soo Park and James Yoon (eds.), *Proceedings of ICKL 11*, pages 115–147, Seoul: International Circle of Korean Linguists.
- Vallduví, Enric and Vilkuna, Maria. 1998. On rheme and kontrast. In Peter Culicover and Louise McNally (eds.), *Syntax and Semantics 29: The Limits of Syntax*, pages 79–108, New York: Academic Press.
- Wescoat, Michael T. 2002. *On Lexical Sharing*. Ph. D. thesis, Stanford University.
- Yoon, James Hye-Suk. 2003. What the Korean Copula Reveals about the Interaction of Morphology and Syntax. In Patricia M. Clancy (ed.), *Japanese/Korean Linguistics*, volume 11, pages 34–49, CSLI, Stanford Linguistics Association.

# Toward a unified analysis of the scope interpretation of complex predicates in Japanese: Evidence from the light verb construction

Yusuke Kubota 

Ohio State University

Proceedings of the 12th International Conference on  
Head-Driven Phrase Structure Grammar

Department of Informatics, University of Lisbon

Stefan Müller (Editor)

2005

Stanford, CA: CSLI Publications

pages 232–252

Kubota, Yusuke. 2005. Toward a unified analysis of the scope interpretation of complex predicates in Japanese: Evidence from the light verb construction. In Stefan Müller (ed.), *Proceedings of the 12th International Conference on Head-Driven Phrase Structure Grammar, Department of Informatics, University of Lisbon*, 232–252. Stanford, CA: CSLI Publications. DOI: 10.21248/hpsg.2005.13. 



## Abstract

In this paper, I first make an observation that there is a certain parallelism in the scope interpretation possibilities of adverbs and quantifiers with respect to different types complex predicates in Japanese, drawing on a comparison of the light verb construction and the causative construction. I will then argue that previous approaches to complex predicates in Japanese in the lexicalist tradition (Matsumoto 1996; Manning et al. 1999) fail to capture this generalization successfully. Finally, building on a novel approach to syntax/semantics interface in HPSG by Cipollone (2001), I develop an analysis of the semantic structure of complex predicates that accounts for the empirical observation straightforwardly.

## 1 Introduction

The ‘biclausality’ of complex predicates has always been one of the central topics in Japanese generative grammar since its very inception (see Kuroda (1965), Kuno (1973) and Shibatani (1976) for earliest discussions). Certain complex predicates (with the causative construction being the representative case) in Japanese, despite the lexical integrity of the governing and governed predicates, exhibit apparent biclausality effects with respect to interpretive phenomena such as binding, adverb scope and quantifier scope.<sup>1</sup>

In classical transformational grammar, this fact was accounted for by positing biclausal deep structure for these constructions and stipulating that the deep structure is the relevant representation for these interpretive phenomena. Nowadays, this picture might appear to be too simplistic, but it should be noted that this seemingly rather outdated perspective has an important claim (albeit rarely made explicit even in those days) tied to it that is often absent in subsequent more ‘sophisticated’ approaches. That is, in this classical picture, the notion of ‘biclausality’ is one and the same for *all* the interpretive phenomena in question. An immediate implication of this claim is that whether or not a particular construction exhibits biclausality with respect to any of these phenomena should strictly coincide with whether or not it does so for other phenomena. The validity of this claim is of course an empirical question. To the best of my knowledge, however, dissenting voices to the classical account have largely neglected to address this question explicitly, despite the fact that they often end up abandoning this claim of the earlier approach.

The apparent biclausality of complex predicates has been a significant challenge to nonderivational theories of grammar. It was not until the late nineties that

---

<sup>†</sup>I would like to thank Bob Levine, Carl Pollard, David Dowty, Detmar Meurers and the participants of the 12th HPSG conference for helpful discussion. Of course, all remaining errors are mine.

<sup>1</sup>The observation that these biclausality effects are not exhibited unsystematically, that is, that they are found only with interpretive phenomena and not with lower-level morphological/phonological phenomena in such constructions is attributed to Paul Kiparsky by Manning et al. (1999).

a fully elaborate and precise account of this long-standing problem was worked out by Manning et al. (1999). While this work counts as a distinguished milestone in the development of HPSG as a fully surface-oriented lexicalist theory, what they effectively did there was to accommodate each of the apparent puzzles by bringing in separate techniques independently developed up to that point in the literature of HPSG and LFG. Manning et al. (1999) remain silent as to this apparently chimeric aspect of their proposal.<sup>2</sup> In particular, the question of whether the analysis straightforwardly extends to other complex predicate constructions in Japanese (including those that do not exhibit biclausality for the phenomena mentioned above), is not seriously considered. As we will see in subsequent sections, however, Manning et al.'s (1999) approach faces significant problems precisely because of the mutual unrelatedness of the mechanisms they employ in accounting for different biclausality phenomena. That is, in their analysis, there is no way to straightforwardly capture the empirical generalization that the availability of scope ambiguity for adverbs and quantifiers always coincides.

This paper first presents data from the light verb construction in Japanese, which does not exhibit the kind of scope ambiguity for adverbs and quantifiers observed in the causative construction. After closely examining the problems this construction poses to previous approaches to complex predicates in lexicalist frameworks (Manning et al. (1999) and Matsumoto (1996)), I proposes an alternative to Manning et al.'s (1999) analysis, building on the work by Cipollone (2001), which introduces a novel approach to syntax-semantics interface in HPSG. The proposed analysis, while still maintaining all the insights of Manning et al.'s (1999) original proposal, overcomes its deficiency by giving a more unified treatment of adverb scope and quantifier scope. The present approach, therefore, is in a sense an attempt to recover an overlooked insight from the era of classical transformational grammar in the contemporary lexicalist setup.

## 2 Semantic properties of raising and control light verbs

### 2.1 Raising and control light verbs

As was noted by the pioneering work by Grimshaw and Mester (1988), the combination of so-called light verbs (LVs) and verbal nouns<sup>3</sup> (VNs) in Japanese exhibits a somewhat surprising pattern of argument realization; the arguments of the VN, which is categorically a noun, are sometimes allowed to appear verbally case-marked.<sup>4</sup> Thus, in the following pair, (1a) exhibits a case assignment pattern quite

---

<sup>2</sup>In fact, they do suggest in their conclusion (although in passing) that the 'complex argument structure' is the source of biclausality for these phenomena in their analysis. However, upon closer examination, it turns out that this is not really the case. See the discussion in the following sections for further details.

<sup>3</sup>In this paper, I will refer to (typically Sino-Japanese) argument-taking nouns with verb-like meanings that can appear in construction with light verbs as 'verbal nouns'.

<sup>4</sup>By 'verbal case', I mean, following Iida (1987:104) among others, forms of case marking such as that in *Jon o* 'John ACC' or *Jon ni* 'John DAT', that are typical of arguments of verbs; by contrast,

expected of a nominal category where the goal argument *Tookyoo e no* ‘to Tokyo’ of the VN *yusoo* ‘transport’ appears with the genitive marker *no*, whereas (1b) is an instance of the unexpected pattern where the same goal argument gets realized in a verbal case without the genitive marker.

- (1) a. Karera wa Tookyoo e no bussu no yusoo o si-ta.  
 they TOP Tokyo DAT GEN goods GEN transport ACC do-PAST  
 ‘They transported goods to Tokyo.’  
 b. Karera wa Tookyoo e bussu no yusoo o si-ta.

Since VNs don’t by themselves have the ability to assign verbal cases to their arguments, the LV is presumably responsible for the verbal case marking on an argument of a nominal category here. Grimshaw and Mester (1988) proposed an analysis of the light verb construction in which the arguments of a VN can be totally or partially transferred to the LV and be realized in verbal cases. They dubbed this process ‘argument transfer’.

It was later discovered by Matsumoto (1996) that the range of verbs that trigger ‘argument transfer’ is not limited to the genuine LV *suru* ‘do’; there are a number of raising and control verbs that exhibit patterns of case marking in which ‘argument transfer’ has arguably taken place. Matsumoto gives the following example to illustrate this point:

- (2) Karera wa Tookyoo e bussu no yusoo o hazime-ta.  
 they TOP Tokyo GOAL goods GEN transport ACC begin-PAST  
 ‘They began transporting goods to Tokyo.’ (Matsumoto 1996:77)

In (2), the raising verb *hazime* ‘begin’ subcategorizes for an accusative-marked VN. Just as in (1b), the goal argument *Tookyoo e* ‘to Tokyo’ of the embedded VN appears in a verbal case here. The verbs that enter into this construction with the VN they subcategorize for have meanings and functions similar to raising and control verbs in English. In particular, the subject of the embedded predicate (i.e. the VN) is identified with one of the arguments of the verbs themselves. For this reason, Matsumoto calls these verbs ‘raising and control light verbs’. I follow Matsumoto (1996) in this terminology.<sup>5</sup>

## 2.2 Problems of Matsumoto’s (1996) analysis: adjunct scope and quantifier scope

### 2.2.1 Matsumoto’s (1996) analysis of the light verb construction

Matsumoto (1996) employs the mechanism of functional uncertainty (Kaplan and Zaenen 1989) in LFG to formulate an analysis of LVC. In a nutshell, in his analysis, forms of case marking with the genitive marker that are typical of arguments of nouns such as that in *Jon no* ‘John GEN’ or *Jon e no* ‘John DAT GEN’ are called ‘nominal case’.

<sup>5</sup>I will sometimes call these verbs simply as ‘light verbs’ just for convenience sake, departing from the original use of the term. Also, see Matsumoto (1996) for an extensive list of verbs that fall under this category.

(f-structural) dependents (arguments and adjuncts) of the embedded VN can syntactically (i.e. in the c-structure) appear as sisters of the embedding LV by means of functional uncertainty.<sup>6</sup> The functional uncertainty relation is independently motivated in his analysis in order to account for the (functional) biclausality phenomena in other types of complex predicates.

As pointed out by Yokota (1999), Matsumoto's (1996) analysis incorrectly predicts the possibility of 'adjunct transfer'. That is, sentences like (3b) are predicted to have a reading in which the adjunct syntactically appearing in the verbal modifier form (which is indicated by the absence of the genitive marker on the adjunct in this sentence) semantically modifies the embedded VN. That kind of reading, however, is simply unavailable for these sentences (Yokota 1999).<sup>7</sup>

- (3) a. Bussyu wa Koizumi ni tyokusetu no hoobei o  
 Bush TOP Koizumi DAT direct GEN visit-US ACC  
 mitome-ta.  
 permit-PAST  
 'Bush permitted Koizumi a direct visit to US.'
- b. Bussyu wa Koizumi ni tyokusetu hoobei o mitome-ta.  
 Bush TOP Koizumi DAT directly visit-US ACC permit-PAST  
 'Bush in person permitted Koizumi to visit US.'

An important fact that has hitherto been unnoticed in the literature is that quantifiers behave in the same way as adjuncts with respect to the possibilities of scope interpretation in LVC.<sup>8</sup> A quantificational argument of the VN that is transferred to the LV and that appears verbally case-marked in the higher verbal projection must obligatorily take scope over the LV.

- (4) a. Zeikan wa gyoosya ni Huransu kara no wain dake no  
 customs TOP trader DAT France from GEN win only GEN  
 yunyuu o mitome-ta.  
 import ACC permit-PAST  
 'Customs let the trader only import wine from France.' (permit > only)
- b. Zeikan wa gyoosya ni Huransu kara wain dake yunyuu o  
 customs TOP trader DAT France from wine only import ACC  
 mitome-ta.  
 permit-PAST

---

<sup>6</sup>Space limitations preclude me from giving a detailed examination of Matsumoto's (1996) analysis. For a fuller discussion, see Kubota (2005).

<sup>7</sup>Matsumoto (1996) actually claims that 'adjunct transfer' is possible in LVC. For an extensive discussion on the nonevidencehood of the apparent cases of adjunct transfer brought up by Matsumoto (1996), see Yokota (1999) and Kubota (2005).

<sup>8</sup>Strictly speaking, NPs with focus particles are not (canonical) quantifiers. However, they behave like quantifiers in that they are scope-taking elements, which is the only crucial property relevant to the discussion here. I use these items throughout this paper because the relevant distinction in meaning is clearer than cases involving more 'canonical' quantifiers.

‘The only thing customs let the trader import from France was wine.’  
(only > permit)

In (4a), in which the genitive-marked quantificational NP *wain dake no* ‘only wine’ appears inside the projection of the embedded VN, the quantifier obligatorily takes scope lower than the LV. By contrast, (4b), in which the same quantificational argument gets transferred to the LV and appears without the genitive marker, only allows a reading in which the quantifier takes scope over the LV. The relevant readings are indicated as the English translations of these sentences.

To sum up the observations we have made so far, the raising and control light verb construction does not exhibit scope ambiguity of quantifiers in much the same way as it does not allow adverb ambiguity. As it will become clear below, the correlation of the behaviors of adverbs and quantifiers has an important consequence for their theoretical treatment.

### 2.2.2 Mismatches of syntactic structure and semantic scope of some complex predicates

In contrast to LVC, in some complex predicate constructions, scope ambiguity is observed for both adjuncts and quantifiers.<sup>9</sup> One well-known example of the discrepancy between syntactic structure and semantic scope is the causative construction. As noticed by at least as early as Shibatani (1976), sentences like the following are ambiguous between two readings.

- (5) Taro wa Hanako ni damatte terebi o mi-sase-ta.  
Taro TOP Hanako DAT silently TV ACC watch-cause-PAST  
‘Taro made Hanako silently watch the TV’  
‘Taro silently made Hanako watch the TV.’

In one reading, the adverb modifies the whole complex predicate, giving rise to an interpretation in which the referent of the matrix subject, Hanako, is taken to be the person who is silent. In the other reading, the adverb modifies the embedded verb root and the referent of the subject of the embedded verb root, Taro, is taken to be the person who is silent.

It has also been noted in the literature (Kitagawa 1994; Manning et al. 1999) that similar scope ambiguity is observed with respect to quantificational NPs. The following sentence, which contains a quantificational NP *biiru dake* ‘only beer’, is ambiguous between two readings, as differentiated by the two English translations:

- (6) Naomi wa Ken ni biiru dake nom-ase-ta.  
Naomi TOP Ken DAT beer only drink-cause-PAST  
‘Naomi made Ken drink beer only.’ (cause > only)  
‘The only thing Naomi made Ken drink was beer.’ (only > cause)

---

<sup>9</sup>In fact, this is the very reason that Matsumoto (1996) introduced the functional uncertainty schema which allows not only arguments but also adjuncts of the embedded predicate to syntactically appear as sisters of a higher verb, causing overgeneration in the case of LVC.

The generalization that emerges from the observations made in the previous and present sections is that in the case of (at least) some complex predicates including causatives, narrow scope readings are possible for both adverbs and quantifiers, while in the case of the raising and control light verb construction, such readings are systematically unavailable; the scope of adverbs and quantifiers is entirely determined by their syntactic positions in the latter case.

While Matsumoto's (1996) analysis of complex predicates, as it originally stands, is not equipped with a mechanism that deals with quantifier scope, it is easy to extend his analysis with one along the lines of the proposal by Halvorsen and Kaplan (1995). In this analysis, quantifier scope ambiguity is accounted for by representing quantifier scope at the level of semantic structure and stipulating an uncertainty relation on the mapping between the f-structure and the semantic structure. While this analysis accounts for the scope ambiguity of the causative construction straightforwardly, it comes at the cost of overgeneration in LVC. Without further stipulation, it wrongly predicts that a similar scope ambiguity is possible in LVC. What is worse, the stipulation needed to prevent this overgeneration has to be independent from the one that prevents adverb scope ambiguity in LVC since the two phenomena are dealt with separate mechanisms in this setup.

To summarize the discussion up to this point, in spite of the fact that the data clearly point to a generalization that a certain kind of scope ambiguity is observed in one type of complex predicate (compound verbs including causatives) while it is not in the other (the light verb construction) with respect to both adverbs and quantifiers, there appears to be no principled way of capturing it in the LFG-based architecture proposed by Matsumoto (1996), even if one extends the analysis with a mechanism of quantification.

### **3 Proposal: a theory of semantic complexity of complex predicates**

In this section, I develop a more coherent analysis of the phenomena observed in the previous section. Given the strong parallelism between the scope-taking behaviors of adverbs and quantifiers, it is more plausible to construct a theory of syntax and semantics of complex predicates in which the observed parallelism follows from a single factor, rather than being accounted for separately.

As a basis of the theory to be developed below, I take up a recent proposal by Cipollone (2001), in which an analysis of the Japanese causative construction is given in terms of 'a highly restricted form of structured meanings' (Cipollone 2001:41).<sup>10</sup> In this analysis, Cipollone (2001) proposes to account for the mismatch between syntax and semantics in the causative construction by means of introducing slight compositionality in semantics. That is, the sublexical scope of

---

<sup>10</sup>For the original motivation for the structured meaning approach in formal semantics, see Cresswell (1985). For a discussion on how the setup adopted here differs from this original approach, see Cipollone (2001).

adverbs in the causative complex predicate is licensed by manipulating the internal structure of the semantic representation of a phrase. This obviates the need for resolving all semantic scope in the lexical representation of the head verb, as is done by Manning et al. (1999) (henceforth MSI), while still maintaining lexical integrity.

In this paper, I argue for an extension of Cipollone's (2001) approach mainly from empirical considerations. As will become clear below, a systematic and simple analysis of the scopal properties of different types of complex predicates in Japanese can be obtained by extending the approach of Cipollone (2001) but not that of MSI.

In the next section, we will see that applying MSI's analysis straightforwardly to the raising and control LVs suffers from overgeneration of the kind strikingly similar to that found in Matsumoto's (1996) analysis. After identifying the problems of MSI's approach, I will argue in the final section that by exploring the possibilities opened up by Cipollone, we will be able to obtain a significantly improved perspective from which we can account for the observed parallelism of the scope-taking behaviors of adverbs and quantifiers quite neatly with just a minimum number of stipulations.

### **3.1 The lexicalist analysis of causatives by Manning et al. (1999)**

MSI present several pieces of evidence (including morphological patterns in reduplication and nominalization and ellipsis in question-answer pairs) for the lexicalist analysis of causatives in Japanese.<sup>11</sup> Based on these pieces of evidence, they formulate an analysis of the causative construction in which the verb root and the causative suffix constitute one morphological word. The challenge that such an analysis faces is, of course, how to accommodate the apparent biclausality phenomena with this underlying assumption. What MSI effectively do to resolve this problem is to introduce separate mechanisms/constraints operating on lexical entries of verbs to create a rich lexical representation for the head verb in which all scopal relations are, as it were, 'preconfigured'.

More specifically, adverb scope ambiguity of the causative construction is accounted for by adopting the adjunct-as-argument mechanism (van Noord and Bouma 1994). That is, in their analysis, there are two lexical operations that apply to the lexical entry for a verb: one for creating a complex causative verb from the verb root and the other for inserting an adjunct to the ARG-ST list. Since the semantic scope of the causative predicate and the adverb is fixed at the point of application of these rules, the relative scope relation between the two differ depending on the order of application of these two operations.<sup>12</sup> If the adjunct is first added to the

---

<sup>11</sup>Due to space limitations, the discussion in this section is highly condensed. For a more extensive discussion, the reader is referred to Kubota (2005). Also, the full set of evidence and relevant arguments, see Manning et al.'s (1999) original work (section 2).

<sup>12</sup>The procedural metaphor adopted here and throughout the paper is of course just for expository convenience.

lexical entry for the base verb and then the operation for causative formation applies, we get a lexical entry like the following, where the adjunct scopes lower than the causative suffix:

(7) *hasir-ase* ‘cause to run’

<i>verb</i>																								
PHON	<i>hasir-ase</i>																							
SUBJ	⟨ <b>1</b> NP <sub><i>i</i></sub> ⟩																							
COMPS	⟨ <b>2</b> NP <sub><i>j</i></sub> , <b>3</b> ADV[CONT <b>4</b> ]⟩																							
ARG-ST	⟨ <b>1</b> , <b>2</b> , ⟨PRO <sub><i>j</i></sub> , <b>3</b> ⟩⟩																							
CONT	<b>4</b>	NCL	<table style="border-collapse: collapse;"> <tr> <td style="border-right: 1px solid black; padding-right: 10px;"><i>cause-rel</i></td> <td colspan="2"></td> </tr> <tr> <td style="border-right: 1px solid black; padding-right: 10px;">ACTOR</td> <td style="padding-right: 10px;"><i>i</i></td> <td style="border-right: 1px solid black; padding-right: 10px;">]</td> </tr> <tr> <td style="border-right: 1px solid black; padding-right: 10px;">UNDERGOER</td> <td style="padding-right: 10px;"><i>j</i></td> <td style="border-right: 1px solid black; padding-right: 10px;">]</td> </tr> <tr> <td style="border-right: 1px solid black; padding-right: 10px;">EFFECT</td> <td colspan="2"></td> </tr> <tr> <td style="border-right: 1px solid black; padding-right: 10px;">ARG</td> <td style="padding-right: 10px;"> <table style="border-collapse: collapse;"> <tr> <td style="border-right: 1px solid black; padding-right: 10px;"><i>run-rel</i></td> <td colspan="2"></td> </tr> <tr> <td style="border-right: 1px solid black; padding-right: 10px;">RUNNER</td> <td style="padding-right: 10px;"><i>j</i></td> <td style="border-right: 1px solid black; padding-right: 10px;">]</td> </tr> </table> </td> <td style="border-right: 1px solid black; padding-right: 10px;">]</td> </tr> </table>	<i>cause-rel</i>			ACTOR	<i>i</i>	]	UNDERGOER	<i>j</i>	]	EFFECT			ARG	<table style="border-collapse: collapse;"> <tr> <td style="border-right: 1px solid black; padding-right: 10px;"><i>run-rel</i></td> <td colspan="2"></td> </tr> <tr> <td style="border-right: 1px solid black; padding-right: 10px;">RUNNER</td> <td style="padding-right: 10px;"><i>j</i></td> <td style="border-right: 1px solid black; padding-right: 10px;">]</td> </tr> </table>	<i>run-rel</i>			RUNNER	<i>j</i>	]	]
<i>cause-rel</i>																								
ACTOR	<i>i</i>	]																						
UNDERGOER	<i>j</i>	]																						
EFFECT																								
ARG	<table style="border-collapse: collapse;"> <tr> <td style="border-right: 1px solid black; padding-right: 10px;"><i>run-rel</i></td> <td colspan="2"></td> </tr> <tr> <td style="border-right: 1px solid black; padding-right: 10px;">RUNNER</td> <td style="padding-right: 10px;"><i>j</i></td> <td style="border-right: 1px solid black; padding-right: 10px;">]</td> </tr> </table>	<i>run-rel</i>			RUNNER	<i>j</i>	]	]																
<i>run-rel</i>																								
RUNNER	<i>j</i>	]																						

Quantifier scope is also determined lexically. Building on the work by Pollard and Yoo (1998), MSI develop a lexicalized version of the Cooper storage mechanism of quantifier scope in HPSG, which is formulated as a constraint on objects of type *stem*. Roughly speaking, in this analysis, all quantifier meanings are first collected from the arguments by the lexical head that subcategorizes for it. The quantifiers thus collected are then either retrieved by that lexical head or passed up to a higher head. Thus, in a causative sentence, if the object of the verb root is a quantifier, it is either retrieved by this verb root or inherited to the higher causative suffix and retrieved by the latter. In the former case, we get the narrow scope reading. What is crucial here is that the relevant constraint targets objects of type *stem*. The verb root in the causative construction does not count as an independent word, but it counts as a token of type *stem*. This makes it possible for the verb root to retrieve the quantifier by itself, giving rise to the narrow scope reading.

### 3.2 Problems of MSI’s analysis

MSI’s analysis of causatives can successfully account for adverb scope ambiguity and quantifier scope ambiguity while fully maintaining the lexical integrity hypothesis. The tricks they make use of to achieve this goal are (i) the adjunct-as-argument analysis (for adverb scope) and (ii) the lexical quantifier retrieval mechanism (for quantifier scope).

In this section, I will argue that this approach encounters a significant problem when one tries to extend it to other types of complex predicates that are not discussed in their original paper. Because of the dissociation of the mechanisms accounting for the two scopal phenomena, MSI’s approach fails to capture the generalization that adverbs and quantifiers behave in a similar way with respect to the availability of scope ambiguity for different types of complex predicates.



### 3.2.1 Compound verbs that do not exhibit scope ambiguity

It has often been pointed out in the literature of complex predicates in Japanese (Kageyama 1993; Matsumoto 1996; Yumoto 2002) that not all Japanese compound verb constructions have uniform syntactic and semantic properties. In particular, there is a class of compound verbs<sup>13</sup> including *V-wasureru* ‘forget to V’ and *V-naosu* ‘re-V’ that do not exhibit scope ambiguity of adverbs and quantifiers, as opposed to those including causatives that do allow for such ambiguity.

- (8) a. Jon wa sono ziken o koi ni tuuhoo-si-wasure-ta.  
John TOP that accident ACC intentionally report-do-forget-PAST  
‘John deliberately forgot to report that accident.’  
b. Jon wa sono ziken o koi ni tuuhoo-si-naosi-ta.  
John TOP that accident ACC intentionally report-do-redo-PAST  
‘John deliberately re-reported that accident.’

(8a) does not allow an interpretation in which the adverb *koi ni* ‘intentionally’ semantically modifies the V1 (the first element of the compound verb), where the act of reporting the accident, which John forgot to carry out, was supposed to be intentional. Likewise for (8b). The only legitimate interpretation available for this sentence is one in which the adverb semantically modifies the V2 (the second element of the compound verb), where intentionality is ascribed to the aspect of redoing something, not to the act itself that was redone.

As noted by Yumoto (2002), quantifier scope data go parallel to the above adverb scope data. Again, the narrow scope interpretation is unavailable for these verbs.

- (9) a. Naomi wa yooguruto dake tabe-wasure-ta.  
Naomi TOP yogurt only eat-forget-PAST  
‘The only thing that Naomi forgot to eat was yogurt.’  
b. Naomi wa yooguruto dake tabe-naosi-ta.  
Naomi TOP yogurt only eat-redo-PAST  
‘The only thing that Naomi ate again was yogurt.’

(9a) unambiguously means that the only thing Naomi forgot to eat was yogurt. A reading in which the quantifier takes scope lower than the V2 is unavailable. Likewise, the only reading available for (9b) is one that can be paraphrased as the English translation given above, where the quantifier takes wide scope.

The existence of the kind of compound verbs that do not allow scope ambiguity is somewhat troublesome for MSI’s analysis. Analyzing them on a par with the causative construction leads to overgeneration. Given that different mechanisms are in charge of controlling the availability of different scope interpretations of adverbs and quantifiers in their analysis, it turns out that separate stipulations are needed to block unwanted narrow scope readings for adverbs and quantifiers.

---

<sup>13</sup>Following Matsumoto (1996), I will call this type of compound verbs ‘type III’ compound verbs.

As we have already seen, LVC shows the same pattern as these compound verbs. In the next section, it will become clear that the fact that the correlation of the patterns of adverb scope and quantifier scope obtains cutting across different types of complex predicates makes it even more difficult for MSI's approach to get the facts right and give them a uniform explanation. It would end up in stipulating a set of similar constraints at different places in the grammar (one at the level of lexical rules and the other at the level of lexical entries).

### 3.2.2 Light verbs

Unlike compound verbs, both the embedded predicate (VN) and the embedding one (LV) are independent words in LVC. This can easily be confirmed by the fact that it fails the the set of tests used by MSI to determine the wordhood of the causative construction:<sup>14</sup> in reduplication, what is reduplicated is the verb alone and not the sequence of the VN and the LV (10); it is not possible to make a nominalized form from the sequence of the accusative-marked VN and the LV by *-kata* suffixation (11); in question-answer pairs, the LV alone can serve as a perfectly well-formed answer to a question (12). All of these data point to the LV's independent status as a word.

- (10) hoobei o mitome mitome  
 visit-US ACC permit permit  
 'permitting visits to US repeatedly'
- (11) \*hoobei o mitome-kata  
 visit-US ACC permit-way  
 intended: 'the way to permit someone to visit US'
- (12) Hoobei o mitome-ta? – Mitome-ta (yo).  
 visit-US ACC permit-PAST permit-PAST  
 'Did you permit him to visit US? – Yes, I did.'

Thus, in LVC, the VN and the LV do not form a morphological word but the two are put together in the syntax.

In HPSG, the standard way of analyzing constructions in which arguments of an embedded predicate are realized as arguments of a higher one is to employ the mechanism of argument composition (Hinrichs and Nakazawa 1994). Following previous analyses of Korean light verbs by Ryu (1993) among others, I will assume a version of the argument composition mechanism in which the arguments of the VN are *optionally* inherited to the LV, given the optionality of argument transfer (Grimshaw and Mester 1988; Matsumoto 1996). Thus, an analysis of sentence (2), which involves transfer of one argument from the VN to the LV, can now be sketched out as follows:

---

<sup>14</sup>Further evidence comes from the fact that adverbs and matrix arguments can be places between the LV and VN. See Kubota (2005) for relevant examples.

(13)

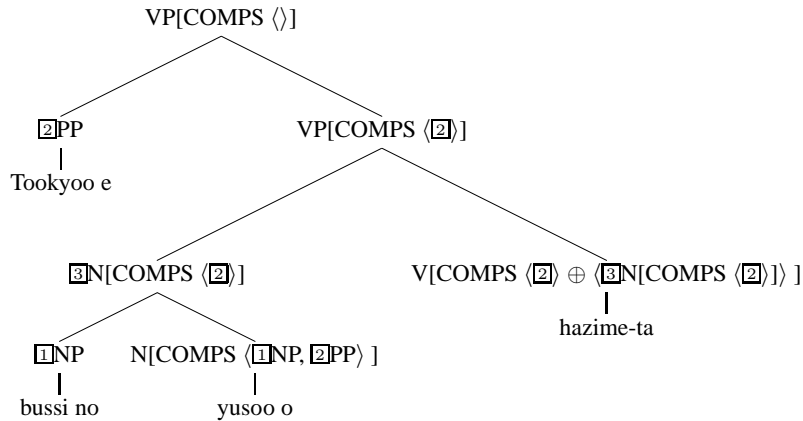

Note that the goal argument PP *Tookyoo e* ‘to Tokyo’, tagged as [2], originally starts out as an argument of the embedded VN and then inherited to the higher verb and discharged in the projection of this higher verb.

Now a problem arises when one combines this fairly uncontroversial approach to LVs with MSI’s analysis of complex predicates. Recall once again that, in MSI’s analysis, adjuncts are formally treated on a par with arguments as elements that appear on the argument structure list of a predicate. Thus, if an adjunct inserted to the argument structure list of the embedded VN is raised to the higher verb by argument composition, the narrow scope reading for an adverb appearing in the higher verbal projection is wrongly licensed for sentences like (3b).

The quantifier scope mechanism assumed by MSI is also problematic in that it overgenerates with respect to LVC in an analogous fashion. In a nutshell, the problem is that nothing prevents the embedded VN from retrieving quantifiers amalgamated from its arguments, since it counts as an independent *stem*. This gives rise to the illicit narrow scope reading.

Thus, MSI’s approach suffers from overgeneration with respect to both adverb and quantifier scope in LVC. The real problem, however, is the fact that there do not seem to be any straightforward way of predicting the unavailability of narrow scope readings for adjuncts and quantifiers in terms of a single principle. The two phenomena could of course be accounted for separately. For example, the fact that adjuncts of a VN cannot be inherited by the subcategorizing LV could be accounted for either by formulating the lexical rule for adjunct insertion in such a way that it does not apply to VNs or by adding a constraint on the lexical entries for raising and control LVs to the effect that elements that can be inherited from the VN are confined to true arguments.<sup>15</sup> Likewise, the fact that narrow scope interpretations are impossible for transferred quantifiers might be accounted for by a stipulation on the lexical entries for raising and control LVs to the effect that if an inherited argument is a quantifier, its quantificational force must not already have

<sup>15</sup>This requires the use of the DEPS feature (Bouma et al. 2001), which is a diacritic feature for distinguishing true arguments from adjuncts in the adjunct-as-argument setup.

been retrieved by the embedded VN.

The stipulations needed to block overgeneration in each case, however, are completely independent of each other. This means that a straightforward extension of MSI's approach to raising and control LVs shares an undesirable property with Matsumoto's (1996) analysis that no principled explanation is given to the parallelism of the behaviors of adverbs and quantifiers.

In order to account for the observed parallelism neatly, one needs a system in which a single representation serves as a controlling factor for the availability of scope ambiguity of different kinds of scope-taking elements (adverbs and quantifiers). In the next section, I will show that one can develop such a system quite easily building on a recent proposal by Cipollone (2001), which makes crucial use of partially transparent semantic representations and noncompositional semantic assembly in terms of it.

### **3.3 Extending Cipollone's (2001) structured semantics for complex predicates**

Cipollone (2001) proposes an analysis of Japanese complex predicates that follows MSI in maintaining the lexical integrity hypothesis but crucially departs from it by rejecting the adjunct-as-argument analysis for adverb scope ambiguity. Roughly put, Cipollone dispenses with this mechanism at the expense of introducing slight noncompositionality in semantics. In his analysis, the internal semantic structure of a complex predicate is made partially transparent so that an adjunct modifying it can look inside and pick up the portion it scopes over. As will become clear in what follows, the merit of adopting Cipollone's (2001) system is that it opens up a possibility for developing an analysis that accounts for the parallelism of adverb scope and quantifier scope in a uniform and elegant manner, something which none of the previous lexicalist analyses of complex predicates (Matsumoto 1996; Manning et al. 1999) have been able to accomplish.

In Cipollone's (2001) original formulation, however, adverb scope and quantifier scope are not treated in a fully parallel fashion. In that paper, the quantifier scope mechanism is just a borrowing from MSI and does not actually take full advantage of the new analytical device being advocated. This means that, as it is, Cipollone's (2001) analysis is no better than other previous proposals. In order to overcome this shortcoming, I will propose below a novel treatment of quantifier scope, which crucially makes use of the new aspect of Cipollone's system where semantic representations are partially transparent. The proposed analysis captures the parallelism of the behaviors adverbs and quantifiers uniformly and straightforwardly.

### 3.3.1 Cipollone's (2001) analysis of adverb scope ambiguity in the causative construction

Within theories of semantics that adhere to strict compositionality, the information of how the meaning of a phrase is built up is not accessible for further manipulation. The idea Cipollone (2001) proposes is to slightly loosen this requirement.<sup>16</sup> By doing so, it becomes possible to let an adverb modifying a complex semantic representation of a causative verb to take scope inside it, giving rise to the narrow scope reading.

Cipollone (2001) technically works out the approach sketched above in HPSG by encoding lambda abstraction in terms of typed feature structures. The CONT value of a phrase is specified as a list of *psoa-abstracts*, representing a chain of lambda abstraction. An object of type *psoa-abstract* is specified for two features LAMBDA and PSOA as shown in (14) and represents a lambda-abstracted formula in which the variable bound by the lambda operator is specified as the value of the LAMBDA feature. If the value of the LAMBDA feature is specified as *none*, there is no variable binding.<sup>17</sup>

$$(14) \left[ \begin{array}{ll} \textit{psoa-abstract} & \\ \text{LAMBDA} & \textit{var}(\textit{psoa}) \vee \textit{none} \\ \text{PSOA} & \textit{psoa} \end{array} \right]$$

The value of the CONT feature of the causative verb *hasir-ase* 'cause to run' will look like the following in this setup!<sup>18</sup>

$$(15) \left\langle \left[ \begin{array}{ll} \text{LAMBDA} \boxed{2} & \\ \text{PSOA} | \text{NCL} & \left[ \begin{array}{l} \textit{cause-rel} \\ \text{CAUSER } j \\ \text{CAUSEE } m \\ \text{EFFECT} \boxed{2} \end{array} \right] \end{array} \right], \left[ \begin{array}{ll} \text{LAMBDA } \textit{none} & \\ \text{PSOA} | \text{NCL} & \left[ \begin{array}{l} \textit{run-rel} \\ \text{RUNNER } m \end{array} \right] \end{array} \right] \right\rangle$$

The order of the elements of the list is crucial in this formulation. The complete semantic interpretation for a sentence is obtained by applying  $\beta$ -reduction to the semantic representation of the top S node, where, for any given two consecutive elements, the right-hand side element is given as an argument to the left-hand side element that serves as a functor.

Cipollone (2001) proposes the following general schema for adverbs in his setup:

<sup>16</sup>As Cipollone (2001) argues at length, the abandonment of compositionality in its strictest sense is not so much a big deal as it might appear. It is also important to recognize that the approach of Cipollone is not a whole-sale abandonment of compositionality, but a rather modest one. That is, it is significantly conservative in that there is no room for building up the meaning of a phrase from elements that are not lexically anchored.

<sup>17</sup> $\textit{var}(\textit{psoa})$  is a notation for a variable over objects of type *psoa*.

<sup>18</sup>The partially transparent semantic representation like this is obtained in Cipollone's analysis by means of minimally revising MSI's lexical rule for causative compound verb formation. For the exact formulation of the relevant rule, the reader is referred to Cipollone (2001).

$$(16) \left[ \begin{array}{l} \text{MOD} \left[ \text{CONT} \oplus \left\langle \left[ \begin{array}{l} \text{LAMBDA} \quad [2] \\ \text{PSOA} \quad [3] \end{array} \right] \right\rangle \oplus [4] \right] \\ \text{CONT} \quad [1] \oplus \left\langle \left[ \begin{array}{l} \text{LAMBDA} \quad [2] \\ \text{PSOA} \quad \phi([3]) \end{array} \right] \right\rangle \oplus [4] \end{array} \right]$$

This says that the semantic contribution of the adverb can be incorporated into any of the elements (each corresponding to the semantic contribution of a component of the complex predicate) of the chain of lambda expressions specified as the value of the CONT feature of the head.<sup>19</sup> Cipollone gives the following representation for the narrow scope reading for the sentence *Gakkoo de hasir-ase-ta* ‘(I) made him run at school’ as an illustration of how his analysis works.

$$(17) \left[ \begin{array}{l} \text{VP} \left[ \text{CONT} \left[ \begin{array}{l} \text{LAMBDA} \quad [1] \\ \text{PSOA} \mid \text{NUC} \left[ \begin{array}{l} \text{cause-rel} \\ \text{CAUSER} \quad [1] \\ \text{CAUSEE} \quad [2] \\ \text{EFFECT} \quad [3] \end{array} \right] \end{array} \right] \left[ \begin{array}{l} \text{LAMBDA} \quad [5] \text{none} \\ \text{PSOA} \mid \text{NUC} \left[ \begin{array}{l} \text{location-rel} \\ \text{LOCATION} \quad \text{school} \\ \text{EVENT} \quad [7] \mid \text{NUC} \left[ \begin{array}{l} \text{run-rel} \\ \text{RUNNER} \quad [2] \end{array} \right] \end{array} \right] \end{array} \right] \end{array} \right] \\ \text{NP} \left[ \begin{array}{l} \text{MOD} \quad [5] \\ \text{CONT} \quad [4] \end{array} \right] \quad \text{VP} \left[ \text{CONT} \left\langle \left[ \begin{array}{l} \text{LAMBDA} \quad [3] \\ \text{PSOA} \quad [7] \end{array} \right] \right\rangle \right] \\ \text{gakkoo de} \qquad \qquad \qquad \text{hasir-ase-ta} \end{array} \right]$$

The locative adverbial phrase *gakkoo de* ‘at school’, which syntactically combines with the whole causative verb *hasir-ase* ‘cause to run’, ‘discharges’ its semantic contribution onto the second element [9] of the list-valued semantic representation of the complex predicate, which corresponds to the meaning of the verb root, thereby satisfying the general schema for adverbs given in (16). Thus, in this case, the CONT value of the projected VP represents the narrow scope reading for the adverbial phrase.

### 3.3.2 Getting the quantifier scope mechanism right

Cipollone’s (2001) analysis of quantifier scope overgenerates the narrow scope readings for type III compound verbs and LVC since the relevant mechanism is just a borrowing from MSI’s analysis. In order to overcome this problem, I propose here a radical departure from the lexical treatment of quantifier scope of MSI and return to a somewhat more conservative syntactic account of quantifier scope, which crucially makes use of the partially transparent semantic representations made available in Cipollone’s (2001) approach. The advantage of this modification becomes clear in the next section where it is argued that the parallelism of

<sup>19</sup>  $\phi$  is a function that takes a feature structure of the sort *psoa* (i.e. an object roughly corresponding to a propositional denotation) and gives back as value the result of applying the relevant meaning of the modifier to that *psoa*.

adverb scope and quantifier scope naturally falls out under the proposed analysis by virtue of the fact that the form of the semantic representation is crucially made responsible for controlling the scope interpretation possibilities for both adverbs and quantifiers.

The analysis of quantifier scope I propose here is essentially a mirror image of the analysis of adverb scope proposed by Cipollone (2001): quantifiers are allowed to freely pick up any portion of the complex semantic representation to scope over, just as adverbs are allowed to do so. This can technically be achieved by formulating the following Quantifier Scope Principle:

(18) Quantifier Scope Principle

$$\left[ \text{CONT } \boxed{1} \oplus \left\langle \left[ \text{PSOA} \begin{array}{l} \text{QUANTS } \langle \boxed{5} \rangle \oplus \boxed{2} \\ \text{NCL } \boxed{3} \end{array} \right] \right\rangle \oplus \boxed{4} \right]$$

$$\rightarrow \text{H} \left[ \text{CONT } \boxed{1} \oplus \left\langle \left[ \text{PSOA} \begin{array}{l} \text{QUANTS } \boxed{2} \\ \text{NCL } \boxed{3} \end{array} \right] \right\rangle \oplus \boxed{4} \right], \left[ \text{QSTORE } \{ \boxed{5} \} \right]$$

I assume that all local trees where the type of the CONT value of the head daughter is a list of *psoa-abstracts* (i.e. projections of categories with predicative meanings including at least verbs, adjectives and verbal nouns but not ordinary referential nouns) must conform to this principle. A sample analysis for the narrow scope interpretation for sentence (6) is given in (19).

(19) Narrow scope reading for (6)

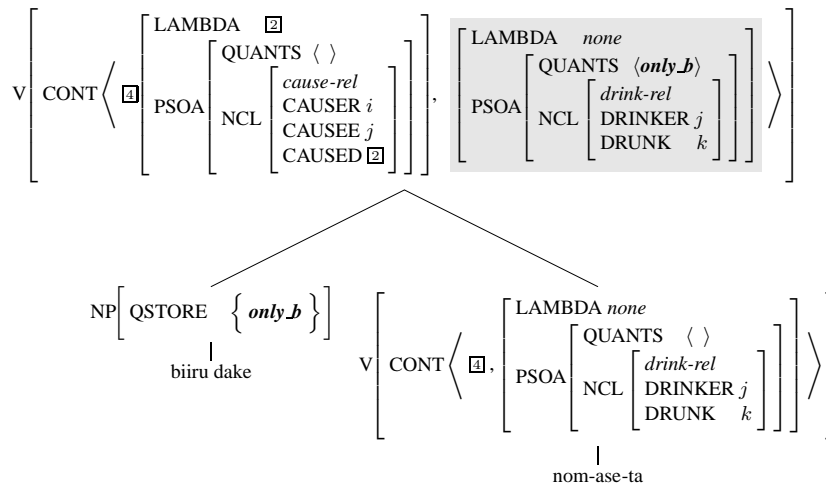

In this tree, at the node where the quantifier combines with the head verbal projection, the quantifier gets retrieved by the second element of the list-valued semantic representation of the head, which corresponds to the meaning of the verb root. In this way, sublexical scope of quantifiers is licensed. Notice that the present analysis crucially makes use of the fact that the internal semantic structure is made visible to phrases attaching from outside in the case of the causative construction.

The quantifier scope mechanism now works in a way that resembles the adverb scope mechanism much more closely than was the case in Cipollone's (2001) original account. What is noteworthy is that the structure of the semantic representation of the head plays a crucial role in determining the possible scope interpretations in both cases. Thus, the present analysis straightforwardly predicts the parallelism between the patterns of adverb scope and quantifier scope with respect to different types of complex predicates, as we will see in the next section.

### 3.3.3 Solving the problem of light verbs: lexically triggered opacity of semantic structures

Given that not all complex predicates in Japanese allow for scope ambiguity of adverbs and quantifiers, it is apparent that the kind of transparent semantic representation Cipollone (2001) proposes for causatives and some other complex predicates in Japanese should be available only for a certain subset of complex predicates.

The unavailability of scope ambiguity for type III compound verbs can be accounted for by stipulating the output of the lexical rules for this type of compound verbs to have semantic representations that are not transparent unlike their counterparts that allow for scope ambiguity.<sup>20</sup> By ensuring this, it is guaranteed that there is only one way for adverbs and quantifiers combining with them to determine their scope, that is, to take scope over the whole complex predicate, since there is only one element in the CONT value of the head daughter.

For LVC, the relevant stipulation can be introduced in the lexical entry for the LV. That is, the lexical entry for the LV should be specified in such a way that its semantic representation does not make the part coming from the embedded VN visible to elements syntactically combining with it at higher nodes. Thus, the lexical entry for the verb *mitome* 'permit' will be something like the following.<sup>21</sup>

(20) Lexical entry for *mitomeru* 'permit':

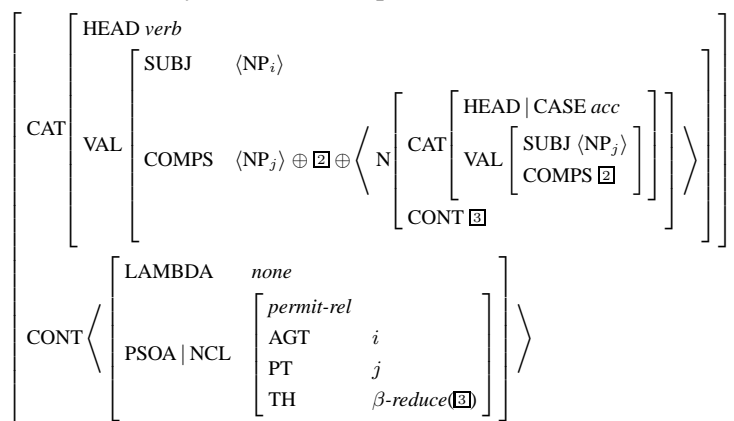

<sup>20</sup>For details, see Kubota (2005).

<sup>21</sup> $\beta$ -reduce is a function that takes an unreduced 'lambda term' (list of *psoa*-abstracts in the current setup) and gives back a fully ' $\beta$ -reduced' counterpart of that term (which is a nested single *psoa*-abstract). A formal definition of this function is given in Kubota (2005).



What is crucial in this lexical entry is that the CONT value is specified as a singleton list, which has the effect of concealing the internal structure of this complex predicate meaning to phrases attaching from outside. Thus, once the lexical entry for the LV is given as in (20), the unavailability of the narrow scope reading for adverbs and quantifiers appearing outside the projection of the VN is straightforwardly predicted. Sentence (3b) can be analyzed as in (21). In this sentence, the scope of the adverb *tyokusetu* ‘directly’ is determined in reference to the CONT value of the projection of the LV *mitome* ‘permit’. The adverb can pick up any portion of this list-valued semantic representation of the head daughter to take scope over. However, since the list in question is rendered singleton by virtue of the lexical specification of the LV (20), there is only one option available here for this adverb to determine its scope: to take scope over the whole complex predicate.

(21) Tree for (3b)

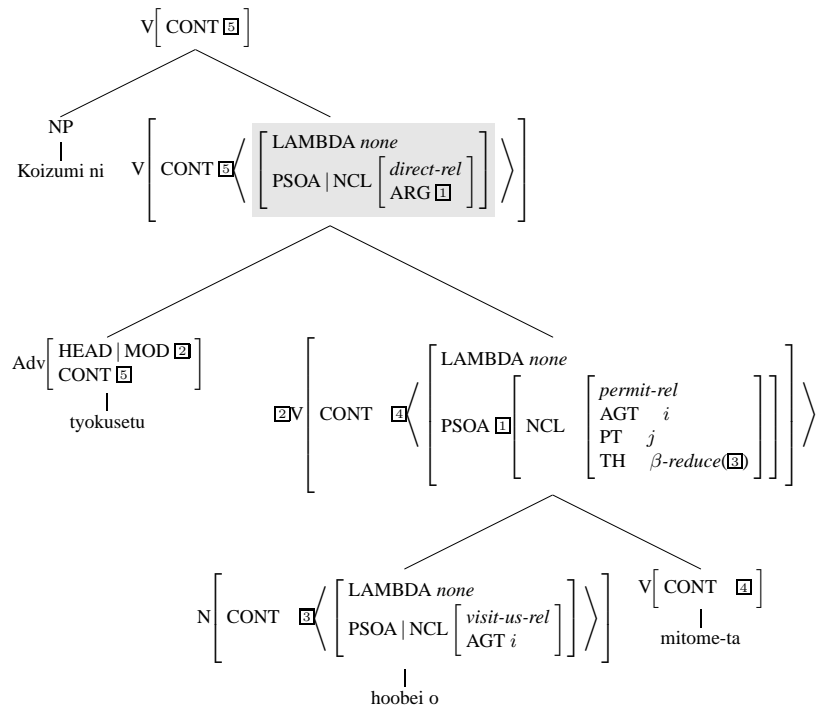

The present account also correctly predicts the fact that when an adjunct appears within the projection of the VN, bearing the genitive case marker, it can only be interpreted as modifying the embedded VN. That is, in a tree in which an adjunct combines with the embedded VN rather than the embedding LV as in (21), that adjunct scopes directly over the VN and the result is fed into the THEME slot of the semantic representation of the higher LV, giving us the desired narrow scope reading.

The quantifier scope data is also straightforwardly accounted for. The impossibility of the narrow scope reading for a quantifier appearing outside the projection of the VN falls out as a consequence of the semantic opacity of raising and control

LVs; in this case, the quantifier cannot ‘look into’ the semantic representation of the complex predicate composed of the VN and LV to pick up a subportion of it to scope over, just as an adverb cannot do so. Thus, if a quantifier is transferred to the higher verb and appears in the higher verbal projection as in (4b), it obligatorily takes wide scope, to the desired effect.

Finally, one can easily confirm that the present analysis also makes a correct prediction for sentences like (4a), in which the quantifier appears within the projection of the VN. Essentially, the account is parallel to the case of an adjunct appearing inside the projection of the VN. The local tree at which the quantifier combines with the projection of the VN has to satisfy the Quantifier Scope Principle, which has the effect of fixing the scope of the quantifier immediately above the VN (thus, below the LV).

## 4 Conclusion

The present paper discussed the scope interpretation of adverbs and quantifiers in different types of complex predicates in Japanese. In particular, we made a detailed comparison of LVC and the causative construction. From this comparison (together with the discussion of different types of compound verbs in Japanese), an empirical observation emerged that the availability of scope ambiguity with respect to a particular type of complex predicate for these elements always coincides with each other. Based on this generalization, I proposed an extension of a novel approach to syntax-semantics interface in HPSG by Cipollone (2001), which exploits the idea of introducing slight noncompositionality in semantics, and argued that it is empirically superior to (conservative extensions to) earlier approaches to complex predicates in HPSG (Manning et al. 1999) and LFG (Matsumoto 1996).

Finally, it should be noted that I am not arguing against the general approach of these earlier lexicalist analyses of complex predicates in Japanese. On the contrary, the present account is an attempt to advance this line of research one step further by overcoming an inadequacy of previous proposals and giving a more coherent treatment of the patterns observed in the language. Within the past decade or so, a number of loosely related approaches to underspecified semantics have been proposed in the literature of HPSG and LFG (most notably, Minimal Recursion Semantics (MRS) (Copestake et al. to appear)). Given that there is a certain similarity of these approach to the one adopted in this paper, it is quite likely that the problems of Manning et al.’s (1999) analysis I have pointed out above can be resolved by adopting MRS (or whichever of these similar approaches) and reformulating relevant scoping mechanisms in their analysis along the lines of the present proposal. Conducting this kind of radical reformulation, however, entails an abandonment of a fundamental assumption of MSI’s analysis, which is that the apparent biclausality phenomena can be accommodated by resolving all scoping relations explicitly in the lexicon. Thus, once one introduces an approach like MRS to MSI’s setup, that would virtually result in a recast of the present proposal in a slightly different

setup. I have no objection to such a reformulation, but, at the same time, I do not find any convincing evidence for an advantage of such an approach over the one proposed in the present paper.

## References

- Bouma, Gosse, Malouf, Rob and Sag, Ivan A. 2001. Satisfying Constraints on Extraction and Adjunction. *Natural Language and Linguistic Theory* 19(1), 1–65.
- Cipollone, Domenic. 2001. Morphologically Complex Predicates in Japanese and What They Tell Us About Grammar Architecture. In Michael W. Daniels, David Dowty, Anna Feldman and Vanessa Metcalf (eds.), *Ohio State University Working Papers in Linguistics*, volume 56, pages 1–52, Department of Linguistics, The Ohio State University.
- Copestake, Ann, Flickinger, Dan, Sag, Ivan A. and Pollard, Carl. to appear. Minimal Recursion Semantics: An Introduction <http://lingo.stanford.edu/sag/papers/copestake.pdf>.
- Cresswell, Max J. 1985. *Structured Meanings*. Cambridge, Massachusetts: The MIT Press.
- Grimshaw, Jane and Mester, Armin. 1988. Light Verbs and  $\theta$ -marking. *Linguistic Inquiry* 19, 205–232.
- Halvorsen, Per-Kristian and Kaplan, Ronald M. 1995. Projections and Semantic Description in Lexical-Functional Grammar. In Mary Dalrymple, Ronald Kaplan, John T. Maxwell III and Annie Zaenen (eds.), *Formal Issues in Lexical-Functional Grammar*, pages 279–292, Stanford: CSLI Publications.
- Hinrichs, Erhard W. and Nakazawa, Tsuneko. 1994. Linearizing AUXs in German Verbal Complexes. In John Nerbonne, Klaus Netter and Carl J. Pollard (eds.), *German in Head-Driven Phrase Structure Grammar*, CSLI Lecture Notes, No. 46, pages 11–38, Stanford: CSLI Publications.
- Iida, Masayo. 1987. Case-Assignment by Nominals in Japanese. In Masayo Iida, Stephen Wechsler and Draga Zec (eds.), *Working Papers in Grammatical Theory and Discourse Structure*, CSLI Lecture Notes, No. 11, pages 93–138, Stanford: CSLI Publications.
- Kageyama, Taro. 1993. *Bunpoo to Go-keisei (Grammar and Word Formation)*. Tokyo: Hituzi Syobo.
- Kaplan, Ronald and Zaenen, Annie. 1989. Long-distance Dependencies, Constituent Structure, and Functional Uncertainty. In Mark Baltin and Anthony

- Kroch (eds.), *Alternative Conceptions of Phrase Structure*, pages 17–42, Chicago: The University of Chicago Press.
- Kitagawa, Yoshihisa. 1994. *Subjects in Japanese and English*. Outstanding Dissertations in Linguistics, New York and London: Garland Publishing.
- Kubota, Yusuke. 2005. Light Verbs and the Scope Interpretation of Complex Predicates in Japanese, MS. The Ohio State University.
- Kuno, Susumu. 1973. *The Structure of the Japanese Language*. Cambridge, Massachusetts: The MIT Press.
- Kuroda, S.-Y. 1965. *Generative Grammatical Studies in the Japanese Language*. Ph.D.thesis, MIT.
- Manning, Christopher D., Sag, Ivan A. and Iida, Masayo. 1999. The Lexical Integrity of Japanese Causatives. In Robert Levine and Georgia Green (eds.), *Studies in Contemporary Phrase Structure Grammar*, pages 39–79, Cambridge and New York: Cambridge University Press.
- Matsumoto, Yo. 1996. *Complex Predicates in Japanese*. Stanford/Tokyo: CSLI Publications/Kurosio Publishers.
- Pollard, Carl J. and Yoo, Eun Jung. 1998. A Unified Theory of Scope for Quantifiers and *Wh*-Phrases. *Journal of Linguistics* 34, 415–445.
- Ryu, Byong-Rae. 1993. Structure Sharing and Argument Transfer: An HPSG Approach to Verbal Noun Constructions. SfS-Report 04-93, Department of Linguistics, The University of Tübingen, Tübingen.
- Shibatani, Masayoshi. 1976. Causativization. In Masayoshi Shibatani (ed.), *Japanese Generative Grammar*, volume 5 of *Syntax and Semantics*, pages 239–294, New York and Tokyo: Academic Press.
- van Noord, Gertjan and Bouma, Gosse. 1994. The Scope of Adjuncts and the Processing of Lexical Rules. In *Proceedings of COLING 94*, pages 250–256, Kyoto.
- Yokota, Kenji. 1999. Light Verb Constructions in Japanese and Functional Uncertainty. In Miriam Butt and Tracy Holloway King (eds.), *Proceedings of the LFG99 Conference*, Stanford: CSLI Publications.
- Yumoto, Yoko. 2002. *Goi-gainen Koozoo no Kumikae o Tomonau Toogo-teki Hukugoo-go* (Syntactic Compounds Involving Restructuring of Lexical Conceptual Structures). In Takane Ito (ed.), *Bunpoo-ron: Rekisikon to Toogo* (*Grammatical Theory: Lexicon and Syntax*), volume 1 of *Gengo-kagaku* (*Language Sciences*), pages 61–90, Tokyo: University of Tokyo Press.

# A new HPSG approach to Polish auxiliary constructions

Anna Kupść 

Polish Academy of Sciences and CNRS, Loria

Jesse Tseng

CNRS, Loria

Proceedings of the 12th International Conference on  
Head-Driven Phrase Structure Grammar

Department of Informatics, University of Lisbon

Stefan Müller (Editor)

2005

Stanford, CA: CSLI Publications

pages 253–273

Kupść, Anna & Jesse Tseng. 2005. A new HPSG approach to Polish auxiliary constructions. In Stefan Müller (ed.), *Proceedings of the 12th International Conference on Head-Driven Phrase Structure Grammar, Department of Informatics, University of Lisbon*, 253–273. Stanford, CA: CSLI Publications. DOI: 10.21248/hpsg.2005.14.



## Abstract

This paper presents an analysis of constructions involving the *l*-form of the verb in Polish, including primarily the past tense, the conditional mood, and the future tense. Previous approaches have attempted to treat these uniformly as auxiliary verb constructions. We argue against a unified treatment, however, in light of synchronic and diachronic evidence that indicates that only the future tense and the conditional still involve auxiliaries in modern Polish. We show that the past tense is now a simple tense, although the *l*-forms appear in combination with agreement affixes that can appear in different places in the sentence. We provide an account of the common linearization properties of the past tense markings and the conditional auxiliary. We present a detailed HPSG analysis of the past tense construction that relies on the introduction of two interacting agreement features. We then discuss the consequences of our proposals for the analysis of the conditional and future auxiliary constructions, and finally, we offer a treatment of constructions involving inflected complementizers in Polish.

## 1 Introduction

The “*l*-participle” form of the verb in Polish (for short: *l*-form, so called because it ends in *l* or *ł*, usually followed by a vowel) is inflected for number and gender and agrees with the subject. As an example, the different *l*-forms for the verb *czytać* ‘read’ are as follows:

- (1) singular: *czytał* (masculine), *czytała* (feminine), *czytało* (neuter);  
plural: *czytali* (masculine human), *czytały* (other).

The *l*-form can appear in the past tense, in the conditional mood, and in the future tense. In the past tense, the *l*-form requires additional endings in 1st and 2nd persons: 1sg *-(e)m*, 2sg *-(e)ś*, 1pl *-śmy*, and 2pl *-ście*, cf. (2a–b).

- (2) a. Ja *czytałem* książkę. My *czytaliśmy* książkę.  
I read.m.sg-1sg book we read.m.pl-1pl book  
b. Ty *czytałeś* książkę. Wy *czytaliście* książkę.  
you read.m.sg-2sg book you read.m.pl-2pl book  
c. On *czytał* książkę. Oni *czytali* książkę.  
he read.m.sg book they read.m.pl book  
‘I/you/he/we/you/they read a book.’

In conditional constructions, the *l*-form appears in combination with the element *by*. In this case, it is *by* that takes the personal endings in 1st and 2nd persons:

---

<sup>†</sup>We would like to thank three anonymous reviewers for the HPSG Conference, the audiences of the IPIAN Linguistic Engineering Group seminar (Warsaw, April 2005) and the HPSG Conference (Lisbon, August 2005), where versions of this paper were presented.

- (3) a. Ja *bym* czytał książkę. My *byśmy* czytali książkę.  
 I CND-1sg read.m.sg book we CND-1pl read.m.pl book
- b. Ty *byś* czytał książkę. Wy *byście* czytali książkę.  
 you CND-2sg read.m.sg book you CND-2pl read.m.pl book
- c. On *by* czytał książkę. Oni *by* czytali książkę.  
 he CND read.m.sg book they CND read.m.pl book
- ‘I/you/he/we/you/they would read a book.’

Finally, in the future tense, the *l*-form combines with future forms of the auxiliary *być* ‘be’, (4).<sup>1</sup> In this use, however, we do not find the 1st and 2nd person endings that characterize the past tense and the conditional.

- (4) a. Ja *będę* czytał książkę. My *będziemy* czytali książkę.  
 I FUT.1sg read.m.sg book we FUT.1pl read.m.pl book
- b. Ty *będziesz* czytał książkę. Wy *będziecie* czytali książkę.  
 you FUT.2sg read.m.sg book you FUT.2pl read.m.pl book
- c. On *będzie* czytał książkę. Oni *będą* czytali książkę.  
 he FUT.3sg read.m.sg book they FUT.3pl read.m.pl book
- ‘I/you/he/we/you/they will read a book.’

In the past tense, the endings can be attached directly to the *l*-form (*agglutination*) as in (2), or they can appear at a distance, somewhere to the left (*tmesis*, (5)). In the latter configuration, the past tense resembles the conditional and the future, which also involve a “bare” *l*-form.

- (5) a. *Jam* czytał książkę. *Myśmy* czytali książkę.  
 I-1sg read.m.sg book we-1pl read.m.pl book
- b. *Tys* czytał książkę. *Wyście* czytali książkę.  
 you-2sg read.m.sg book you-2pl read.m.pl book

Some previous accounts of Polish verbal constructions, e.g., Borsley and Rivero (1994), Borsley (1999), Kupść (2000), have attempted to provide a unified analysis of the three uses of *l*-form verbs in (3)–(5) as auxiliary constructions, i.e., they are treated as a syntactic combination of the *l*-form with an auxiliary verb, shown schematically in (6).<sup>2</sup>

<sup>1</sup>The future tense can also be formed with the infinitive, instead of the more recent *l*-form construction; the same auxiliary is used in both cases.

<sup>2</sup>In fact, not all the authors assume the same syntactic structure for all the uses or a flat structure as in (6), but these differences are irrelevant for the current discussion.

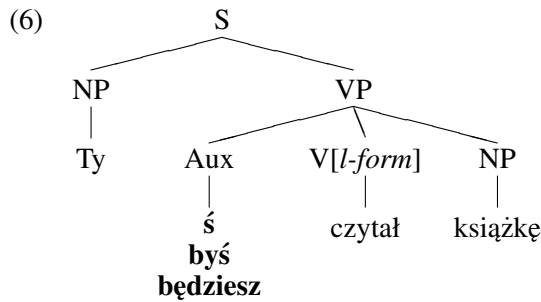

Such an account, however, overlooks the fact that in the past tense there is no auxiliary for the *l*-form to combine with in the 3rd person. Recall that there is no ending in the 3rd person, singular or plural (2c), and thus, the syntactic structure in (6) is inapplicable in these cases (unless, of course, an empty category is assumed).<sup>3</sup>

In fact, there is further evidence against a uniform treatment of the three constructions involving the *l*-form. In the next section, we will focus on the divergent properties of the past tense and conditional constructions.

## 2 Empirical Observations

There are a number of crucial differences between the conditional particle *by* and the past tense markings that suggest strongly that they do not have the same grammatical status.

### 2.1 Past tense

In the past tense, the personal markings have different properties when they are attached to or detached from the *l*-form—compare (2) and (5).

When the personal markings directly follow the *l*-form, they induce morphophonological changes in their host. With a masculine singular subject, an epenthetic vowel *e* must be inserted before the singular markings *-m* and *-ś*, cf. (2a-b) and (7a). This creates an additional syllable, which results in stress shift, and with certain verbs, leads to a vowel shift *ó* to *o* (7a).<sup>4</sup> In the plural, the addition of the markings *-śmy*, and *-ście* can, for some speakers or in fast speech, shift the stress one syllable to the right (7b).

- (7) a. P**O**mógl → po**MO**gł**e**m  
 help.m.sg help.m.sg-1sg
- b. po**MO**gli → ?pomog**LI**ś**my**  
 help.m.pl help.m.pl-2pl

<sup>3</sup>The striking absence of a 3rd person ending in modern Polish has a historical explanation, which will be briefly sketched in §3.

<sup>4</sup>Capital letters mark lexical stress. With isolated exceptions, words in Polish have penultimate stress.



These observations suggest that the postverbal markings are suffixes. Another piece of evidence comes from coordination data, discussed also by Bański (2000). The personal ending has to be repeated on all conjuncts if it is realized to the right of the *l*-verb (8). (For some speakers this requirement can be relaxed in the plural).

- (8) Często [czytałem i pisał\*(em)].  
 often read-1sg and write(-1sg)  
 ‘I often read and wrote.’

According to the criteria of Miller (1992), the obligatory repetition of an item in coordination speaks in favor of its affix status. Therefore, (8) further supports the suffix status of the personal markings in agglutinated past tense forms.

When the personal markings are realized at a distance from the *l*-form, they are quite particular about the phonological properties of their host. Bański (2000) characterizes the conditions in terms of phonological “friendliness” between the host and the marking. Broadly speaking, the host must end in a vowel or another highly sonorous segment, but the different markings impose specific constraints, which are subject to wide variation among speakers (especially in the plural). The restrictions seem to be weaker than Bański suggests:

- (9) a. The 1sg marking (-*m*) can only follow a word ending in a non-nasal vowel (i.e., not *ɛ* or *ɔ*), or (possibly) the glide *j*;  
 b. The 2sg marking (-*ś*) can additionally (but somewhat marginally) follow a nasal vowel or *j*, and possibly the sonorants *l*, *r*, *l* in a simple coda;  
 c. The 1-2pl forms (-*śmy* and -*ście*) can follow any vowel, but words ending in a single consonant other than a sibilant (e.g., *sz*, *ż*, *cz*) are also potential (marginal) hosts.

Such combinatory restrictions are common for affixes but not for sequences of syntactic items. It should be noted that the evidence is less compelling for the plural marking.

Epenthetic *e*-insertion before -*m* and -*ś* is only possible with a few lexical items, e.g., *już* ‘already’, *jak* ‘as’, *tam* ‘there’ or *choć* ‘although’, and the resulting suffixed forms (e.g., *jużem*, *jakeś*) sound distinctly archaic. There is no vowel change or stress shift with hosts other than the *l*-form. Finally, wide scope over coordination is possible (10) (Bański (2000) overlooks this possibility).

- (10) Często*m* [czytał i pisał].  
 often-1sg read and write  
 ‘I was often reading and writing.’

The possibility of wide scope over coordination does not distinguish between affix and syntactic clitic status, according to the criteria in Miller (1992).

## 2.2 Conditional constructions

The placement of the conditional element *by* is analogous to that of the personal endings in the past tense: it can be attached directly to the *l*-form, e.g., *czytałbym*, *czytałbyś*, *czytaliby*, otherwise it has to appear somewhere to its left, as illustrated in (3). Other properties of conditional constructions, however, are quite different from the past tense.

First, unlike in the past tense, the element *by* is present in all persons (3): 1sg *bym*, 2sg *byś*, 1pl *byśmy*, 2pl *byście*, 3sg/pl *by*. Second, the forms of conditional *by* are phonologically weak, but they impose no phonological restrictions on the preceding word. They can follow a word ending in any segment (i.e., any of the vowels and consonants that appear word-finally in Polish); this is the same behavior as observed for Polish pronominal clitics. Also, the presence of conditional *by* never has a morphophonological effect on the preceding material (again, as in the case of pronominal clitics, e.g., Dłuska (1974), Rappaport (1988)). Finally, the conditional particle can take wide scope over a coordination of VPs in both preverbal (11a) and postverbal (11b) positions.

- (11) a. Często *bym* [czytał i pisał].  
often CND-1sg read and write
- b. Często [czytałbym i pisał(*bym*)].  
often read-CND-1sg and write(-CND-1sg)  
'I would often read and write.'

According to Miller (1992), the optional repetition of the postverbal conditional particle in (11b) excludes an affix analysis. On the other hand, the wide scope over coordination in preverbal positions, (11a), does not distinguish between affix and syntactic clitic status.

## 2.3 Common properties

Despite the differences, there are also some similarities between the past tense and conditional forms. First of all, the *l*-form in the past tense and the conditional element *by* take identical personal endings: *by-m*, *by-ś*, *by-śmy*, *by-ście*.

The past tense markings and the forms of *by* are subject to the same placement restrictions: they can immediately follow the *l*-form, e.g., (2) and (11b), or they appear somewhere to its left, (5) and (3), but without escaping from the clausal projection of the *l*-form, (12). Also, all positions further to the right of the *l*-form are excluded (13). There are similar constraints on the position of Polish pronominal clitics with respect to the verb (Kupść, 2000).

- (12) a. Mówi, [że ty przeczytałeś / przeczytałbyś tę książkę].  
says that you read-2sg / read-CND-2sg this book  
'(S)he says that you read / would have read this book.'
- b. \*Mówisz / byś, [że ty przeczytał tę książkę].  
says-2sg / CND-2sg that you read this book

- (13) \* Ty przeczytał książkęś / byś.  
 you read book-2sg / COND-2sg  
 ‘You read / would have read the book.’

The past tense endings and the forms of *by* always require a prosodically appropriate host. An immediate consequence of this is that they can never appear sentence-initially:<sup>5</sup>

- (14) \* Ś / Byś ty przeczytał książkę.  
 2sg / COND-2sg you read book  
 ‘You read / would have read the book.’

## 2.4 Summary

These observations suggest that the past tense endings, both in pre- and postverbal positions, are much more closely bound to the preceding word than the conditional particle. In fact, their behavior is more typical of morphological suffixes than of independent syntactic items. Therefore, we will treat the past tense markings as inflectional elements. On the other hand, the forms of conditional *by* are syntactic words, but they are clitics, subject to special word order constraints.

The data presented above highlight distinct properties of conditional and past tense constructions and indicate that, despite certain similarities, the two constructions should be analyzed independently. In §4, we will present a proposal along these lines.

Before continuing to the next section, we should mention one final construction in Polish involving the *l*-form, illustrated by the embedded clauses in the following examples:

- (15) a. On powiedział mi, żebym / abym / bym ja przyszedł.  
 he say me.dat COMP-1sg I come  
 ‘He told me to come.’
- b. Ostrzegam was, żebyście / abyście / byście tego nie robili.  
 warn.1sg you, COMP-2pl that NEG do  
 ‘I warn you not to do that.’
- c. Nie chcę, żebyśmy / abyśmy / byśmy się spóźnili.  
 NEG want.1sg COMP-1pl REFL be-late  
 ‘I don’t want us to be late.’

“Subjunctive” clauses of this type are usually described as special uses of the conditional mood (Swan, 2002), but in fact they have quite different properties, as Borsley (1999) points out. They do involve an element superficially identical to

<sup>5</sup>There is a complementizer homophonous with *byś* in (14) that does appear initially (it is not a clitic); see the discussion of (15).

conditional *by*, with the same inflectional endings. But in this construction, its position is completely fixed: it must introduce the clause, possibly preceded by *że-* or *a-*, from which it cannot be separated. We agree with Borsley's conclusion that these cases cannot involve the conditional auxiliary, and that the forms *żeby*, *aby*, and *by* should be treated as complementizers that introduce clauses with an *l*-form verb, and they show the peculiar property of inflecting to agree with the subject of this verb. We do not adopt Borsley's analysis of these forms, however; we return to this question at the end of the paper.

### 3 Historical Development

In order to better understand the complex behavior of the Polish past tense forms, we sketch their historical development, based on Andersen (1987).

The modern Polish past tense endings evolved from Old Polish forms of the auxiliary verb BE given in (16).

(16)	Old Polish		Modern Polish	
	strong	weak	weak	strong
1sg	jeśm	-(e)śm / (e)m	-(e)m	jestem
2sg	jeś	-(e)ś	-(e)ś	jesteś
3sg	jest / je	∅	∅	jest
1pl	jesm(y)	-(e)smy	-(e)śmy	jesteśmy
2pl	jeście	-(e)ście	-(e)ście	jesteście
3pl	są	∅	∅	są

In Old Polish, there were two forms of BE: strong (orthotonic) and weak (phonologically reduced, atonic). The modern Polish past tense endings evolved from the Old Polish weak forms of BE. Note that already in Old Polish (13th century), there was no weak form in the 3rd person. The modern Polish strong form of BE serves only as a present tense form and cannot participate in the formation of the past tense.

The origins of the modern Polish past tense date back to pre-Polish. At that time, only one (strong) form of BE was available and the counterpart of the contemporary past tense was a construction formed by the *l*-participle and the auxiliary BE (e.g., 3sg: [mlŭvilŭ jestŭ] '(he) has said').

In Old Polish, the two forms of BE (16) could participate in the formation of the past tense. The latter were more common and indicated the unmarked use, whereas the strong 3rd person forms *jest* (sg.) and *są* (pl.) could be added for emphasis in all persons (with agreement in number with the subject):

- (17) a. 1sg: [...-(e)m ... mówił (jest)]  
 b. 1pl: [...-(e)smy ... mówili (są)]  
 c. 3sg: [mówił (jest)], 3pl: [mówili (są)]

Old Polish had no weak form in the 3rd person and so only emphatic constructions were still auxiliary constructions. The placement of the weak BE was quite

rigid and it could appear only after the first stressed word of the clause (“second position”).

In early modern Polish, the optional emphatic forms *jest/są* fall out of use, while weak forms of BE are no longer restricted to second position, but instead they can appear after any stressed word in the clause (to the left of the verb). In the modern language, the original forms of the auxiliary BE have been reinterpreted as person/number agreement markings and the *l*-participle has become a finite (non-present) verb. Postverbal position is also possible, i.e., the *l*-form combines directly with the personal marking (agglutination).

Andersen (1987) quotes statistics from Rittel (1975) indicating that in current Polish there is a strong preference for the agglutinated forms (e.g., *czytałem*), while the endings in other positions appear much less frequently. Hence, the past tense markings in Polish are still undergoing a centuries long transition from second-position clitics to verbal affixes.

## 4 Proposed Analysis

### 4.1 Auxiliaries

#### 4.1.1 The conditional auxiliary *by*

Given the empirical properties identified in the previous sections, we believe that Borsley (1999) and Kupść (2000) are correct in treating inflected forms of conditional *by* appearing to the left of the *l*-form verb as auxiliary verbs, and in fact we extend the same analysis to *by* when it appears immediately to the right of the *l*-form. In all cases, the forms of *by* satisfy the following partial lexical description:

$$(18) \left[ \begin{array}{l} \textit{word} \\ \left[ \begin{array}{l} \textit{clitic} \\ \left[ \begin{array}{l} \text{HEAD} \\ \left[ \begin{array}{l} \textit{verb} \\ \text{VFORM } \textit{cond} \\ \text{AUX } + \\ \text{NEG } - \end{array} \right] \end{array} \right] \\ \text{SS} \\ \left[ \begin{array}{l} \text{ARG-ST} \\ \left\langle \begin{array}{l} \boxed{1} \text{ NP, VP} \\ \left[ \begin{array}{l} \text{HEAD | VFORM } \textit{l-form} \\ \text{SUBJ } \langle \boxed{1} \rangle \\ \text{COMPS } \langle \rangle \end{array} \right] \end{array} \right\rangle \end{array} \right] \end{array} \right] \end{array} \right]$$

This description essentially reflects the standard HPSG analysis of auxiliaries as subject-raising verbs, selecting a verbal complement with a specific verbal form. As observed in Kupść (2000), there is no direct evidence for the flat structure of conditional auxiliary constructions postulated in Borsley (1999), and so we assume simple VP-complementation here. The feature  $[-\text{NEG}]$  is specified in order to

ensure that *by* is never negated; in conditional structures in Polish, negation can only be expressed (in the form of the element *nie*) on the *l*-form:

- (19) a. \*Ty nie *byś* wczoraj widział tego filmu  
 you NEG CND-2sg yesterday see that film  
 b. Ty *byś* wczoraj nie widział tego filmu.  
 you CND-2sg yesterday NEG see that film  
 ‘You wouldn’t have seen that film yesterday.’

#### 4.1.2 [ $\pm$ CLITIC-HOST]

As specified in (18), the forms of *by* are syntactic clitics, and therefore subject to particular linearization constraints. First of all, *by* must appear either in the sentence field<sup>6</sup> to the left of the *l*-form verb, or immediately following the *l*-form. Its exact position is determined primarily by prosodic structure (see for example Mikoś and Moravcsik (1986) and Bański (2000)). We believe that a DOMAIN-based analysis (Reape, 1994) is the best way to handle the linearization possibilities, although we cannot offer a full account in this paper. We simply introduce a shorthand boolean feature CL(ITIC)-HOST to identify words that satisfy (marked [+CL-HOST]) or do not satisfy ([−CL-HOST]) the prosodic and other conditions for hosting a clitic immediately to the right. Typical clitic hosts include subject pronouns, *wh*-words, and complementizers, but in principle the range of possibilities is very large. Monosyllabic prepositions are typical words which are [−CL-HOST].

Non-prosodic conditions on CL-HOST are most apparent in the post-verbal sentence field. All verbs (including *l*-forms) can be [+CL-HOST], so clitics such as conditional *by* and pronominal clitics<sup>7</sup> can appear immediately to their right. But after the rightmost verb in a clause (and the clitics that it hosts, if any), all other words are [−CL-HOST]. Consequently, no clitics (or the past tense endings) can appear in this field—recall also example (13):

- (20) a. My zobaczyli(*by*)śmy dawno słonia.  
 we see(-CND)-1pl long-ago elephant  
 ‘We saw / would have seen an elephant a long time ago.’  
 b. \*My zobaczyli dawnośmy / byśmy słonia.  
 c. \*My widzieli dawno słoniaśmy / byśmy.

The suffixed adverb and noun in the last two examples are phonologically well-formed, and they would be grammatical in the preverbal sentence field. But here they are both [−CL-HOST], and this is a constraint determined simply by linear

<sup>6</sup>We use the term “field” in a purely descriptive way, without suggesting that any version of the topological fields approach, as used for the analysis of German word order, would be applicable to Polish.

<sup>7</sup>As argued in Kupś (2000), Polish pronominal clitics are syntactic items.

order, one that cannot be overridden by prosodic or syntactic considerations in this case.<sup>8</sup>

To account for clitic clusters (including those immediately to the right of the *l*-form verb), we assume that clitics can themselves be [+CL-HOST] and host clitics to their right. As noted in Witkoś (1997), the relative order of pronominal and conditional clitics is very constrained as pronominal clitics tend to follow rather than precede the conditional auxiliary, (21a) vs. (21b).

- (21) a. Ty *byś* go widział. / Ty widział*byś* go.  
 you CND-2sg him.cl see you see-CND-2sg him.cl
- b. ?\* Ty go *byś* widział. / \*Ty widział go *byś*.  
 you him.cl CND-2sg see you see him.cl CND-2sg

Borsley (1999) argues for two different analyses of *by*, depending on its position to the left or to the right of the *l*-form. For the combination of an *l*-form verb followed by *by*, he proposes a special rule of morphological compound formation. We see no evidence (stress shift or vowel quality alternations, for example) to motivate a distinct treatment of *by* in this case. In our account, *by* is always a clitic, and has to be hosted by a [+CL-HOST] element, whether this happens to be the *l*-form verb itself or some other word to the left.

#### 4.1.3 The future auxiliary

The forms of the future auxiliary (4) differ from conditional *by* in that they are full syntactic words, not clitics. It therefore does not depend on a [+CL-HOST] element, and can appear in a wider range of positions, in particular to the right of the *l*-form and in sentence-initial position:<sup>9</sup>

- (22) a. (Ty) *będziesz* widział ten film.  
 (you) FUT.2sg see this film  
 ‘You will see this film.’
- b. Ty widział *będziesz* ten film. / Ty widział ten film *będziesz*.  
 you see FUT.2sg this film you see this film FUT.2sg

Furthermore, the VP complementation proposed for *by* in (18) may be inadequate for the future auxiliary. “Clitic climbing” phenomena in Polish, which are discussed in Kupść (2000), may be better analyzed by assuming complement raising and a flat structure, as proposed for French auxiliary constructions by Abeillé and Godard (2002). (We will not go into the details in this paper.)

<sup>8</sup>But see the discussion of (32) below.

<sup>9</sup>Swan (2002) claims that the inverted order illustrated in (22b) is only possible if the auxiliary combines with an infinitival complement (see fn. 1), but in fact an *l*-form is also possible, as this example shows.

## 4.2 Past tense agreement markings

Like the conditional auxiliary, the past tense elements *-m*, *-ś*, *-śmy*, and *-ście* can appear either in the preverbal sentence field, or immediately to the right of the *l*-form verb. Although these two options result in superficially distinct constructions, we present a single analysis that covers both cases.

### 4.2.1 Floating suffixes

We begin with the analysis of past tense elements that “float” in the preverbal sentence field. We are guided by the following empirical observations, discussed in detail in §2.

- The past tense elements are not independent syntactic items in modern Polish, but suffixes.
- These suffixes can appear in a variety of positions and attach to a variety of hosts, and the possibilities cannot be effectively characterized in terms of syntactic category, syntactic function, or phrase structure.
- The suffixes are obligatory with 1st and 2nd person subjects, but completely absent in the 3rd person.

Taken together, these facts pose serious problems for any analysis of the past tense elements as auxiliary verbs. In fact, we find the last point to be a convincing argument on its own, but technically it is not an insurmountable obstacle. One could appeal to a phonologically empty auxiliary, or propose an auxiliary-less account just for the 3rd person, as Borsley (1999) does.

The first two points provide arguments against an auxiliary treatment of cases where the past tense elements are actually present (in the 1st and 2nd persons). One might suggest, for example, that the Polish phenomenon is similar to auxiliary contraction in English (e.g., *I'll*, *we've*, *you'd*). But the English facts are much simpler, in that the contracted auxiliary always appears in the same position as the full auxiliary, and it always contracts with the subject. In Polish, the varied placement possibilities for the past tense elements and the wide range of possible hosts make the analyses proposed for English (see Bender and Sag (2001) and references therein) inapplicable. Another crucial difference is that in Polish, the past tense suffixes have no corresponding full form; this seems to exclude an analysis where the forms are produced by late phonological reduction (as proposed for syllabic contracted auxiliaries in English), because such processes are not usually obligatory.

We therefore reject the auxiliary approach. We consider the past tense elements to be personal agreement markings; they therefore do not have syntactic head or functor status. We treat the past tense in Polish as a simple tense, with the *l*-form as the head of the structure. A uniform analysis applies in all three persons, but the *l*-form requires the presence of an agreement marking in the 1st and 2nd persons.



The past tense agreement markings are unlike ordinary suffixes, which attach to a particular kind of host. They cannot be analyzed as phrasal suffixes, either; phrasal affixes do combine with a variety of lexical hosts, but they can be characterized as combining with a specific type of phrasal host (NP, VP, etc.), and appearing in a specific position with respect to this phrase (at the left or right edge, typically). This is not the case for the past tense suffixes. In some sense they could be thought of as sentential or clausal affixes, but again, they do not occupy a fixed position in the sentence/clause. Since no existing technical machinery seems to cover this kind of behavior, we have to introduce special mechanisms for the realization of the past tense suffixes (at the morphological level) and for the propagation of information about their presence (in the syntax).

The realization of the floating agreement marking is subject to a strict surface order constraint: it must appear exactly once, somewhere to the left of the *l*-form verb. And unlike in ordinary cases of agreement, no particular word or constituent is targeted to receive the marking. The host can be of practically any category (but never a verb), it can be a complement, adjunct, filler, or complementizer, or embedded inside another phrase with one of these grammatical functions (and within this phrase, the host of the suffix can be the head, the specifier, an adjunct, etc.):

- (23) a. *Dlaczegoś tu przyszedł?* (suffix host: *wh*-adverb filler)  
 why-2*sg* here come  
 ‘Why did you come here?’
- b. [*Bardzo często*m] *widział* ten film. (head of AdvP adjunct)  
 very often-1*sg* see that film  
 ‘I have seen that film very often.’
- c. ... *ale*m *widział* ten film *wczoraj*. (conjunction)  
 but-1*sg* see that film yesterday  
 ‘... but I saw that film yesterday.’
- d. *Już dawno* [*dobrego*m filmu] *nie widział*. (adjunct in NP object)  
 long time good-1*sg* film NEG see  
 ‘I haven’t seen a good film in a long time’

To begin with, then, we need a mechanism to introduce the agreement markings morphologically. The following constraint partitions words into suffixed and unsuffixed classes:

$$(24) \text{ word} \Rightarrow \left[ \begin{array}{l} \text{PHON } \mathbf{F}_{agr}(\mathbb{1},\mathbb{2},\mathbb{3}) \\ \text{MORPH } \left[ \text{FORM } \mathbb{1} \right] \\ \text{SS } \left[ \begin{array}{l} \text{LOC} \mid \text{CAT} \mid \text{HEAD} \quad \mathbb{2} \\ \text{CL-HOST} \quad + \\ \text{AGR-MARK} \quad \mathbf{F}_{I2}(\mathbb{3}) \end{array} \right] \end{array} \right] \vee \left[ \begin{array}{l} \text{PHON } \mathbb{4} \\ \text{MORPH } \left[ \text{FORM } \mathbb{4} \right] \\ \text{SS } \left[ \text{AGR-MARK } \langle \rangle \right] \end{array} \right]$$

$$(25) \quad \mathbf{F}_{12}(\langle \mathbb{I} \text{ [PER 1st} \vee \text{ 2nd]} \rangle) = \langle \mathbb{I} \rangle$$

$$\mathbf{F}_{12}(\langle \text{[PER 3rd]} \rangle) = \langle \rangle$$

The first disjunct in (24) corresponds to suffixed words. Note first of all that these words are required to be [+CL-HOST]; this constrains the possible surface positions of agreement markings, just as for the clitic *by* discussed in the preceding section. The phonological realization of the suffixed word is determined by the function  $\mathbf{F}_{agr}$ , which takes into account the host word's morphological form, its HEAD value, and the index of the personal suffix to be realized. The function has to have access to the HEAD value because the phonological properties and effects of suffixation depend on the identity of the host (whether it is an *l*-form or not), as discussed in §2. In particular, the definition of  $\mathbf{F}_{agr}$  incorporates the phonological restrictions on the host identified in (9). For incompatible combinations (e.g., a word ending in a consonant like [t] cannot take any suffix), the function is undefined and no valid description can be constructed.

We introduce a list-valued attribute AGR-MARK to record the presence and identity of the agreement suffix. The function  $\mathbf{F}_{12}$  serves as a filter to make sure that only 1st and 2nd person suffixes are recorded.<sup>10</sup> The second disjunct of the constraint applies to unsuffixed words, which have an empty AGR-MARK list.<sup>11</sup>

Suffixed words with a non-empty AGR-MARK value participate normally in syntactic combinations, with all possible grammatical functions (head, specifier, adjunct, and so on). The presence of the agreement affix has no effect on the syntactic properties of the host. As mentioned already, a suffix does influence the linearization potential of its host, because the specification [+CL-HOST] requires the suffixed word to end up in a surface position that is compatible with this feature. The exact location of the suffixed word within a phrase cannot be specified: it can be the first word, the last word, or somewhere in the middle. But in all cases, information recording the presence of the affix must be projected. This means that the value of AGR-MARK must be amalgamated and propagated from all daughters in every phrasal combination. This formal mechanism is presented at the end of the next section in (27).

#### 4.2.2 AGR-TRIG and *l*-forms

The agreement marking is required by the *l*-form verb. We encode this by introducing another feature AGR(ELEMENT)-TRIG(GER), which (like AGR-MARK) takes a list of *index* objects as its value. Elements on AGR-TRIG must be discharged by the realization of the corresponding agreement suffix. The value of AGR-TRIG on *l*-forms is determined by the constraint in (26), which also relies on the function  $\mathbf{F}_{12}$  defined in (25):

<sup>10</sup>The function  $\mathbf{F}_{agr}$  can be defined for 3rd person indices (simply returning the original, unsuffixed form of the word), but this is not technically necessary for this constraint.

<sup>11</sup>This is obviously a simplified formulation that ignores other morphophonological processes in Polish that might cause the PHON value to be different from the MORPH | FORM value.

$$(26) \left[ \begin{array}{l} \text{word} \\ \text{HEAD} \mid \text{VFORM} \quad l\text{-form} \end{array} \right] \Rightarrow \left[ \begin{array}{l} \text{ARG-ST} \quad \langle \text{NP}_{\boxed{1}}, \dots \rangle \\ \text{AGR-TRIG} \quad \mathbf{F}_{I_2}(\boxed{1}) \end{array} \right]$$

The result of constraint (26) is that *l*-forms with a 1st or 2nd person subject put their subject's index on their AGR-TRIG list (and thus trigger the presence of the corresponding agreement suffix), while 3rd person *l*-forms have an empty AGR-TRIG value. For the moment let us assume that all words in Polish other than *l*-forms have an empty AGR-TRIG list (although we will see some possible exceptions to this in §4.3).

The AGR-TRIG value propagates along the head projection of the *l*-form. The combined constraint that determines the values of AGR-TRIG and AGR-MARK in phrasal combinations is defined as follows:

$$(27) \left[ \begin{array}{l} \text{phrase} \\ \text{HD-DTR} \mid \text{SS} \quad \left[ \begin{array}{l} \text{AGR-MARK} \quad \boxed{1} \\ \text{AGR-TRIG} \quad \boxed{0} \end{array} \right] \\ \text{NON-HD-DTRS} \quad \langle \left[ \text{SS} \mid \text{AGR-MARK} \quad \boxed{2} \right], \dots, \left[ \text{SS} \mid \text{AGR-MARK} \quad \boxed{n} \right] \rangle \end{array} \right] \\ \Rightarrow \left[ \begin{array}{l} \text{AGR-MARK} \quad \boxed{1} \oplus \boxed{2} \oplus \dots \oplus \boxed{n} \\ \text{AGR-TRIG} \quad \boxed{0} \end{array} \right]$$

#### 4.2.3 Interaction of AGR-TRIG and AGR-MARK

Given constraint (27), the values of the two agreement features will propagate all the way to the maximal clausal projection of the *l*-form. At this point, matching AGR-TRIG and AGR-MARK specifications (which may have originated in very different parts of the clause) are brought together and discharged. This is achieved by means of the following non-branching ID schema (a *hd-only-ph* in the system of Ginzburg and Sag (2001), whose notation we adopt):<sup>12</sup>

$$(28) \left[ \begin{array}{l} \text{phrase} \\ \text{HEAD} \mid \text{TENSE} \quad \text{past} \\ \text{AGR-MARK} \quad \langle \rangle \\ \text{AGR-TRIG} \quad \langle \rangle \end{array} \right] \rightarrow \mathbf{H} \left[ \begin{array}{l} \text{HEAD} \mid \text{VFORM} \quad l\text{-form} \\ \text{AGR-MARK} \quad \mathbf{F}_{I_2}(\boxed{1}) \\ \text{AGR-TRIG} \quad \mathbf{F}_{I_2}(\boxed{1}) \end{array} \right]$$

The mutual discharging of AGR-MARK and AGR-TRIG results in the introduction of past tense (represented here simply as a head feature). The *l*-form itself must be

<sup>12</sup>This representation of the rule is simplified in two ways. First, an additional (most likely semantic) specification is needed to prevent iteration of the rule, because it can be triggered by “matching” empty lists for the 3rd person. Second, the rule can potentially apply at different points in the *l*-form projection, introducing a degree of spurious structural ambiguity. In general, non-branching rules should apply as “late” or as “high” as possible, but this cannot be simply encoded in terms of saturation of VAL and SLASH, given the possibility of coordinating non-maximal verbal projections (with distinct tenses).

lexically underspecified for tense, given the variety of its uses in Polish; it could perhaps be specified as  $\neg present$ . This non-branching schema stops the propagation of AGR-MARK and AGR-TRIG. Note that the resulting phrase is not subject to the constraint in (27), which is formulated only for branching phrases.

Let us work through some examples to illustrate our proposals. Polish allows subject drop, so a complete past tense clause can consist of a single word (a suffixed *l*-form), as in the following analysis:

$$(29) \begin{array}{c} \left[ \begin{array}{l|l} \text{HEAD} & \text{TENSE } \textit{past} \\ \text{AGR-MARK} & \langle \rangle \\ \text{AGR-TRIG} & \langle \rangle \end{array} \right] \\ | \\ \left[ \begin{array}{l|l} \text{AGR-MARK} & \langle \underline{\text{I}} \rangle \\ \text{AGR-TRIG} & \langle \underline{\text{I}} \rangle \end{array} \right] \\ \textit{przyszede\u0144em} \\ \textit{come-1sg} \\ \textit{I came} \end{array}$$

In this case, the first disjunct of (24) applies, so the *l*-form has a non-empty AGR-MARK list. Recall that the phonological function  $\mathbf{F}_{agr}$  has access to the HEAD value, and so the specific properties of *l*-form suffixation can be handled correctly, taking into account the phonological effects illustrated in (7). At the same time, constraint (26) requires the *l*-form also to have a non-empty AGR-TRIG value. The *l*-form thus satisfies the conditions for schema (28).

Fig. 1 is the analysis of the floating suffix example in (23b). It shows how the amalgamation and propagation mechanisms defined in (27) unite the corresponding AGR-MARK and AGR-TRIG specifications, which are introduced quite far apart from one another structurally, and trigger the application of the past tense schema.

Two final constraints need to be defined to complete the analysis. The agreement marking cannot appear to the right of the verb that selects it (13), (20). To block such structures, we formulate the following linear precedence rule:

$$(30) \left[ \text{SS} | \text{AGR-MARK} \langle \underline{\text{I}} \rangle \right] < \overset{\text{HD-DTR}}{\left[ \text{SS} | \text{AGR-TRIG} \langle \underline{\text{I}} \rangle \right]}$$

And finally, at the clausal level, there can be no unlicensed agreement markings (AGR-MARK elements) and no unsatisfied agreement requirements (AGR-TRIG elements):<sup>13</sup>

$$(31) \textit{clause} \Rightarrow \left[ \text{SS} \left[ \begin{array}{l|l} \text{AGR-MARK} & \langle \rangle \\ \text{AGR-TRIG} & \langle \rangle \end{array} \right] \right]$$

<sup>13</sup>The type *clause* is meant to subsume independent root clauses and embedded CPs.

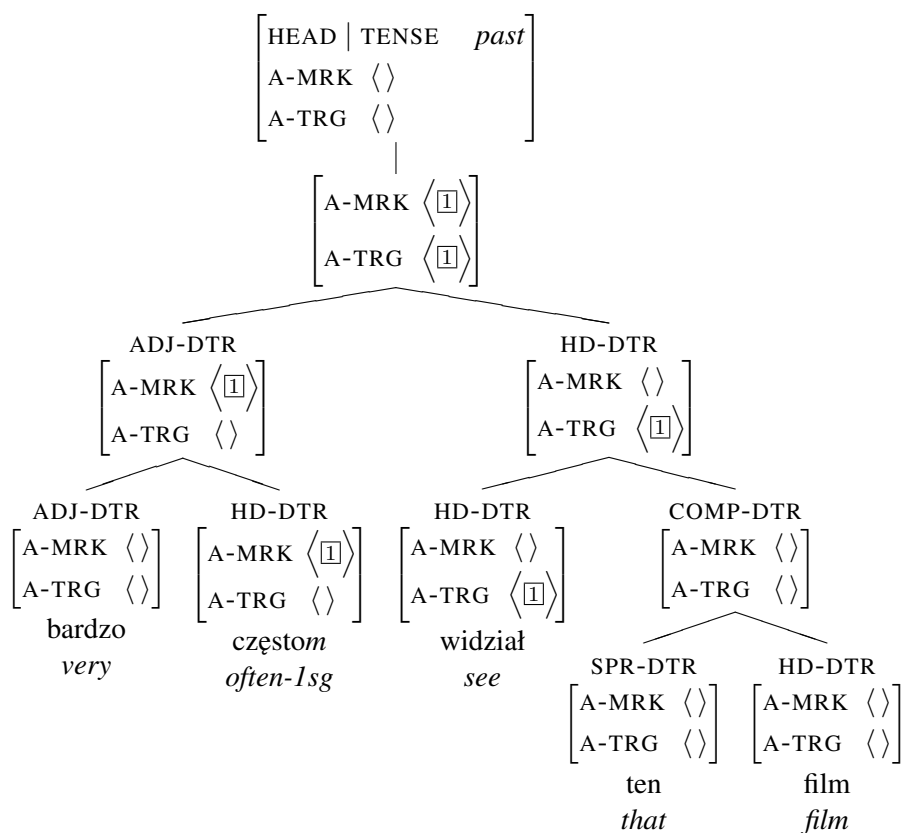

Figure 1: AGR-MARK and AGR-TRIG: Analysis of example (23b)

This constraint accounts for the clause-boundedness of past tense agreement. It excludes the ungrammatical examples in (12), where the required agreement marking is realized outside of the clause headed by the *l*-form. It also blocks the appearance of agreement markings inside a clausal dependent (i.e., sentential complement) of the *l*-form:

- (32) a. *Wszyscy chcieliśmy, [żeby zobaczyć słonia].*  
 all want-*1pl* COMP see.*inf* elephant  
 ‘We all wanted to see an elephant.’
- b. \**Wszyscy chcieli, [żebyśmy zobaczyć słonia].*  
 all want COMP-*1pl* see.*inf* elephant
- c. \**Wszyscy chcieli, [żeby zobaczyć słoniaśmy].*  
 all want COMP see.*inf* elephant-*1pl*

The ungrammatical examples above already fall under the descriptive generalization that agreement suffixes cannot appear in the sentence field to the right of the triggering *l*-form. But the treatment assumed above in §4.1.1—that all words in

this field are simply [–CL-HOST]—cannot apply here, because the sentential complement *can* contain [+CL-HOST] words. But the clitics (and suffixes) that appear in this domain must originate in the embedded clause; the constraint in (31) formalizes this restriction.

### 4.3 Other *l*-form constructions

Let us summarize the analysis just proposed. The *l*-form of the verb introduces an AGR-TRIG specification, and personal agreement markings introduce an AGR-MARK specification. These values propagate to the clause level, but a well-formed clause must have empty values for both features. So an *l*-form must co-occur with the corresponding agreement marking, allowing both features to be discharged, and giving rise to a past tense structure.

But the *l*-form behaves very differently in the other constructions where it appears: the conditional, the future, and with inflected complementizers. As we have seen, these constructions have quite divergent properties, but all three involve the “bare”, unsuffixed *l*-form. None of the dependents of the *l*-form can carry a “floating” agreement marking, either. This is illustrated for the future below:

- (33) a. Ty *będziesz* go widział.  
           you FUT.2sg him see  
           ‘You will see him.’
- b. \*Ty *będziesz* go widziałeś.  
           you FUT.2sg him see-2sg
- c. \*Ty *będziesz* goś widział.  
           you FUT.2sg him-2sg see

At first sight, it seems that the grammatical sentence in (33a) should violate the constraint on clauses in (31): the *l*-form introduces an AGR-TRIG element, but there is no agreement suffix in the clause to discharge it. One possible (but undesirable) solution would be to assume that the future (and the other constructions considered in this section) involve a different *l*-form from the past tense, one that is not subject to the AGR-TRIG constraint in (26).

Actually, we can avoid this move because our analysis already accommodates sentence (33a). According to (27), AGR-TRIG is shared between a phrase and its head daughter, and in this example, the head daughter is the future auxiliary, not the *l*-form. So the *l*-form’s AGR-TRIG value is not propagated to the clause level, and nothing requires it to be discharged.

#### 4.3.1 Auxiliaries

Our treatment of the future and conditional auxiliaries is quite straightforward. They simply require their *l*-form complement to have an empty AGR-MARK list, as in the following description (to be unified with the description of conditional *by* in (18), for example):

$$(34) \left[ \begin{array}{l} \text{word} \\ \text{HEAD} \mid \text{AUX} \quad + \\ \text{ARG-ST} \left\langle \text{NP}, \left[ \begin{array}{l} \text{HEAD} \left[ \begin{array}{l} \text{VFORM} \quad \textit{l-form} \\ \text{TENSE} \quad \neg \textit{past} \end{array} \right] \right] \right\rangle \\ \text{AGR-MARK} \quad \langle \rangle \end{array} \right] \end{array} \right]$$

In combination with the amalgamation of AGR-MARK formulated in (27), the empty list specification ensures that no agreement suffixes appear anywhere in the *l*-form complement. This is only true, however, if the past tense schema in (28) has not applied, with the effect of discharging the agreement lists. This possibility is excluded by the additional specification [TENSE  $\neg$ *past*], which ensures that the auxiliary sees the “initial” values of AGR-MARK and AGR-TRIG.

Something should be said about the values of AGR-MARK and AGR-TRIG on the auxiliaries themselves. The simplest solution is to assume empty lists, and this is a completely unproblematic analysis for the future auxiliary. For conditional *by*, the situation may be more complex, because the endings it takes are exactly the same as the past tense agreement suffixes, suggesting that the same function  $F_{agr}$  as in (24) may be involved.<sup>14</sup> In that case, the forms of *by* could have a non-empty AGR-MARK specification, which would then require a non-empty AGR-TRIG specification (inherited from the *l*-form complement). A head-only schema analogous to (28) would also have to be defined for the conditional. We will not pursue this discussion any further here, but we would like to point out that conditional *by* seems to be slowly losing its auxiliary status in the same way as the former past tense auxiliary, and the indeterminacy in its analysis can be explained as a reflection of this transitional status.

### 4.3.2 Inflected complementizers

Given the classical HPSG treatment of complementizers as marker daughters (i.e., non-heads), the data involving inflected subjunctive complementizers in (15) could be handled exactly like the past tense, in terms of AGR-MARK/AGR-TRIG interaction, with the additional constraint that the agreement suffix must appear on the complementizer. But we follow a more recent trend in HPSG (Ginzburg and Sag, 2001; Tseng, 2002) that treats complementizers as syntactic heads. This is also the approach adopted by Borsley (1999) for the Polish elements *żeby/aby/by*. His analysis, however, involves a very unusual argument inheritance mechanism (a completely flat structure in which the complementizer inherits the *l*-form’s subject and “demotes” it to a complement) that we find quite unmotivated.

It would be convenient for the complementizer to have access to the subject in this way, because it has to inflect to agree with it just like the auxiliaries do, but at

<sup>14</sup>The historical evidence also points in this direction, because the conditional forms used to have a completely idiosyncratic set of endings, which have been “regularized” in modern Polish.

the same time there is no evidence to suggest that the complementizer combines with anything other than a saturated sentence. In our analysis, we do not have to resort to argument manipulation, because the information that the complementizer needs is visible in the sentence's AGR-TRIG value:

$$(35) \left[ \begin{array}{l} \text{word} \\ \text{HEAD} \quad \text{comp} \\ \\ \text{COMPS} \left\langle \text{S} \left[ \begin{array}{l} \text{HEAD} \quad \left[ \begin{array}{l} \text{VFORM} \quad \textit{l-form} \\ \text{TENSE} \quad \neg \textit{past} \end{array} \right] \\ \text{AGR-TRIG} \quad \mathbf{F}_{12} (\textit{index}) \\ \text{AGR-MARK} \quad \langle \rangle \end{array} \right] \right\rangle \end{array} \right]$$

Again, as in the auxiliary description in (34), the non-past specification ensures that the agreement features have not been discharged by rule (28). Consequently, if the *l*-form has a 1st or 2nd person subject, its index will still be on the complement's AGR-TRIG list, and the complementizer can take the appropriate person and number inflection. If the subject is 3rd person, AGR-TRIG is empty (thanks to  $\mathbf{F}_{12}$ ) and in this case there is only one form, *żeby/aby/by*, for both singular and plural.

## 5 Conclusion

We have developed analyses for all uses of the *l*-form in Polish (past tense, conditional, future, and inflected complementizer constructions), taking into account their very distinct grammatical properties. In contrast to many previous approaches, we have not tried to offer a uniform picture, although many analytical building blocks are shared across the analyses. Taking a global view of the phenomena we have examined, at one extreme we have the future tense, which is an ordinary auxiliary verb construction, and at the other extreme the past tense, where the elements that were historically auxiliaries are now simply agreement markings. The conditional is in a transitional state between an auxiliary construction and a simple verb construction. We have presented an auxiliary analysis here, but various aspects of the construction are open to reanalysis. Finally, the inflected complementizers are unusual elements, but they are nevertheless handled straightforwardly in our framework.

## References

- Abeillé, Anne and Godard, Danièle. 2002. The syntactic structure of French auxiliaries. *Language* 78, 404–452.
- Andersen, Henning. 1987. From auxiliary to desinence. In Martin Harris and Paolo Ramat (eds.), *Historical Development of Auxiliaries*, pages 21–52, Berlin: Mouton de Gruyter.



- Bański, Piotr. 2000. *Morphological and Prosodic Analysis of Auxiliary Clitics in Polish and English*. Ph. D.thesis, Uniwersytet Warszawski, Warsaw.
- Bender, Emily M. and Sag, Ivan A. 2001. Incorporating Contracted Auxiliaries in English. In Ronnie Cann, Claire Grover and Philip Miller (eds.), *Grammatical Interfaces in HPSG*, pages 17–32, Stanford, CA: CSLI Publications.
- Borsley, Robert D. 1999. Auxiliaries, Verbs and Complementizers in Polish. In Robert D. Borsley and Adam Przepiórkowski (eds.), *Slavic in Head-Driven Phrase Structure Grammar*, pages 29–59, Stanford, CA: CSLI Publications.
- Borsley, Robert D. and Rivero, María Luisa. 1994. Clitic Auxiliaries and Incorporation in Polish. *Natural Language and Linguistic Theory* 12, 373–422.
- Dłuska, Maria. 1974. *Prozodia Języka Polskiego*. Warsaw: PWN.
- Ginzburg, Jonathan and Sag, Ivan A. 2001. *Interrogative Investigations: The Form, Meaning and Use of English Interrogatives*. Stanford, CA: CSLI Publications.
- Kupść, Anna. 2000. *An HPSG Grammar of Polish Clitics*. Ph. D.thesis, Université Paris 7 and Polish Academy of Sciences.
- Mikoś, M. and Moravcsik, Edith. 1986. Moving Clitics in Polish and Some Cross Linguistic Generalizations. *Studia Slavica* pages 327–336.
- Miller, Philip H. 1992. *Clitics and Constituents in Phrase Structure Grammar*. New York: Garland.
- Rappaport, Gilbert C. 1988. On the Relationship between Prosodic and Syntactic Properties of Pronouns in the Slavic Languages. In Alexander M. Schenker (ed.), *American Contribution to the Tenth International Congress of Slavists*, pages 301–327, Columbus, OH: Slavica.
- Reape, Mike. 1994. Domain Union and Word Order Variation in German. In John Nerbonne, Klaus Netter and Carl Pollard (eds.), *German in HPSG*, pages 151–197, Stanford, CA: CSLI Publications.
- Rittel, Teodozja. 1975. *Szyk wyrazów w obrębie form czasu przeszłego i trybu przypuszczającego*. Wrocław: Ossolineum.
- Swan, Oscar E. 2002. *A Grammar of Contemporary Polish*. Bloomington: Slavica.
- Tseng, Jesse. 2002. Remarks on Marking. In Frank van Eynde, Lars Hellan and Dorothee Beermann (eds.), *Proceedings of the 8th International HPSG Conference*, pages 267–283, Stanford, CA: CSLI Publications.
- Witkoś, Jacek. 1997. Polish Inflectional Auxiliaries Revisited, paper presented at the 30th Poznań Linguistic Meeting, Adam Mickiewicz University, Poznań, Poland, May 1–3, 1997.

# A trace analysis of Korean UDCs

Sun-Hee Lee

Wellesley College

Proceedings of the 12th International Conference on  
Head-Driven Phrase Structure Grammar

Department of Informatics, University of Lisbon

Stefan Müller (Editor)

2005

Stanford, CA: CSLI Publications

pages 274–289

**Keywords:** 8211; in the traditional HPSG analysis of UDCs following Pollard and Sag (1994). It is because in HPSG traces are not all required to have the same feature, unlike in other movement-based approaches including the minimalist program and GB theory. In addition, we argue that the three kinds of Korean UDC elements appearing in gap positions do not form separate categories from their corresponding forms appearing in non-UDCs based on the same semantic and pragmatic properties such as logophoricity and contrastiveness. We also investigate some controversial issues of island constraints and strong crossover with respect to filler-gap linkage in Korean UDCs.

Lee, Sun-Hee. 2005. A trace analysis of Korean UDCs. In Stefan Müller (ed.), *Proceedings of the 12th International Conference on Head-Driven Phrase Structure Grammar, Department of Informatics, University of Lisbon*, 274–289. Stanford, CA: CSLI Publications. DOI: 10.21248/hpsg.2005.15. 

## Abstract

In this paper, we claim that the filler-gap linkage in Korean UDCs needs to be handled at the level of syntax and that unbounded dependencies represented by traces, resumptive pronouns, and resumptive reflexives in Korean can be simply captured - without posing any extra mechanisms - in the traditional HPSG analysis of UDCs following Pollard and Sag (1994). It is because in HPSG traces are not all required to have the same feature, unlike in other movement-based approaches including the minimalist program and GB theory. In addition, we argue that the three kinds of Korean UDC elements appearing in gap positions do not form separate categories from their corresponding forms appearing in non-UDCs based on the same semantic and pragmatic properties such as logophoricity and contrastiveness. We also investigate some controversial issues of island constraints and strong crossover with respect to filler-gap linkage in Korean UDCs.

## 1 Introduction

In Korean, there are various grammatical constructions that involve a long-distance dependency between a gap and some constituent that is coreferential with that gap. The dependency is in principle unbounded and can be captured by a feature percolation mechanism within HPSG. However, certain properties of gaps in Korean unbounded dependency constructions (hereafter UDCs) raise questions as to whether a syntactic approach to this long-distance dependency is appropriate. In fact, some previous researchers, including Kang (1986) and Yoon [1993] have argued that this dependency needs to be handled at the level of semantics, not syntax. In such a semantic approach, UDC gaps are treated as null resumptive pronouns (so-called *pros* in GB terms), and syntactic binding between a gap and its antecedent is not required. However, UDC gaps and *pros* in Korean show different properties with respect to Strong Crossover and Coordination facts. Furthermore, we examine putative resumptive pronouns (RPs), and the resumptive reflexive (RR) *caki* that appear in the same positions of UDC gaps, and argue that these resumptive elements are audible traces. This argument is compatible with resumptive pronoun analyses of Georgopoulos (1991) in Palauan and Vaillette (2001) in Hebrew. In this paper, we claim that the filler-gap linkage in Korean UDCs needs to be handled at the level of syntax and that unbounded dependencies in Korean can be captured by a feature percolation mechanism within HPSG. We also investigate some controversial issues of island constraints and strong crossover with respect to filler-gap linkage in Korean UDCs.

This paper shows that unbounded dependencies represented by traces, RPs, and the RR *caki* can be simply captured - without posing any extra mechanisms - in the traditional HPSG analysis of UDCs following Pollard and Sag (1994). It is

---

<sup>†</sup>I am grateful to Carl Pollard, Bob Levine, Detmar Meurers, and Allison Blodgett for their valuable comments and feedback. Of course, all errors and unclarity are my responsibility.

because in HPSG traces are not all required to have the same feature, unlike in other movement-based approaches including the minimalist program and GB theory. In addition, we conclude that the three kinds of Korean UDC elements appearing in gap positions do not form separate categories from their corresponding forms appearing in non-UDCs based on the same semantic and pragmatic properties such as logophoricity and contrastiveness.

## 2 A Null Pronominal Analysis and Its Problems

Korean has been standardly considered to be a *pro*-drop language. This is a language where a contextually identifiable element or some element introduced in the preceding context can be dropped. Huang (1984) argues that “cool” languages, including Chinese and Korean, are different from “hot” languages, like English, in that cool languages license a zero topic that binds a null element. While Huang argues that the phonologically null element *pro* appears only in the subject position in cool languages, it has been argued that there is no subject-object asymmetry in Korean (Cole (1987)). Since Korean is classified as a *pro*-drop language, it is possible to argue that gaps in UDCs are null resumptive pronouns or *pros*, and that correspondingly, the long-distance dependencies are not syntactic relations but rather semantic binding relations. The following examples show that a gap can be replaced by an overt pronoun or the long-distance reflexive *caki*, which appears to support the semantic binding analysis.

- (1) a. ku namca<sub>i</sub>-nun [ sacang-i eps-umyeon, e<sub>i</sub> motun il-ul  
that man-TOP president-NOM absent-if every work-ACC  
ttmath-aya hayssta ].  
took care had to  
‘As for that man<sub>i</sub>, if the president were absent, (he<sub>i</sub>) had to take care of everything.’
- b. ku namca<sub>i</sub>-nun [ sacang-i eps-umyeon, ku<sub>i</sub>/caki<sub>i</sub>-ka motun  
that man-TOP president-NOM absent-if he/self all  
il-ul ttmath-aya hayssta ].  
work-ACC took care did  
‘As for that man<sub>i</sub>, if the president were absent, he<sub>i</sub> had to take care of everything.’

As for English Cinque [1990] and Postal (1994) propose transformational analyses with null pronominals for English *tough* gaps and parasitic gaps. In Korean, Chae (1998) and Kang (1986) assumed that *tough* constructions, topicalization, and relativization in Korean license *pros*, which are phonologically null elements in the gap position. However, in this study we treat those pronouns and the long-distance (LD) *caki* as audible traces and argue that the filler-gap linkages in Korean UDCs need to be captured by a syntactic mechanism of binding and not just by semantic coreference. Three different kinds of traces show the same phenomenon

with respect to Strong Crossover and Coordination. This suggests that they belong to the same category of trace.

### 3 Properties of Korean UDC Gaps

A UDC gap needs to have a coreferential element within the given sentence. While the syntactic and semantic connectivity between a gap and its antecedent in Korean UDCs is similar to the corresponding English sentences, Korean UDC gaps are known to be less sensitive to island constraints. The following properties have been pointed out by general properties of Korean UDC gaps.

#### [1] Syntactic Connectivity

There are two natural classes of Korean UDCs: strong UDCs and weak UDCs. In the case of strong UDCs, the filler is accompanied by the morphosyntactic case marker that originated from the gapped position, thus the filler shows a strong syntactic association with its gap. Strong UDCs in Korean include the following topic sentence.

- (2) a. Mary-ka *John-eykey* senmwul-ul cwuessta.  
Mary-NOM John-to present-ACC gave  
'Mary gave a present to John.'
- b. *John<sub>i</sub>-eykey-nun* [ Mary-ka *e<sub>i</sub>* senmwul-ul cwuessta].  
John-to-TOP Mary-NOM present-ACC gave  
'As for John<sub>i</sub>, Mary gave a present (to him<sub>i</sub>)

The case markers of the topic element in (2) show that it is syntactically connected to the gap; the dative case *eykey* (to) is required by the verb *cwuta* (give).

#### [2] Sentence-Internal Binding

A UDC gap must have a coreferential element within the same sentence. This property distinguishes UDC gaps from *pros*, which are licensed by various syntactic, semantic, and pragmatic factors. For example, discourse factors allow a repeated or already-known element to be dropped from a sentence in languages like Korean. When this happens, the missing element can be retrieved from the context. However, a UDC gap requires its coreferential element to be present in the given sentence; it cannot be licensed only by context.

#### [3] Island Constraints

With respect to Korean UDCs, it has been argued that some examples of topicalization and relativization are subject to three island constraints: the Complex NP constraint (CNPC), the Sentential Subject constraint, and the Adjunct constraint. This

evidence has been used to support the claim that topicalization and relativization involve NP movement out of gap positions in Korean. In contrast, it has been also pointed out that topic and relative clauses in Korean frequently do violate island constraints (Kang (1986)). Inconsistency of data with respect to island constraints suggests that unlike most previous analyses in GB theory, island constraints cannot be used as a crucial test for determining whether a particular construction is a UDC or not.

However, some crosslinguistic studies have pointed out that sensitivity to island constraints cannot be used as evidence for the existence of a filler-gap linkage. When dealing with English adjunct extractions, Hukari and Levine (1995) argued that island effects are substantially irrelevant to the issue of whether or not adjunct extraction represents a genuine syntactic filler-gap construction. Instead, they argued that adjunct extraction belongs to the same category of UDCs as argument extraction. They based their conclusion on parallel patterns of crossover effects and on cross-linguistic evidence of syntactic binding domain effects. Szabolcsi and den Dikken (1999) also argued that some island constraint effects are relevant to the semantic scope that an expression takes over certain operators.

Considering that island constraint violations are driven by semantic and pragmatic factors but not by a syntactic operation like movement, inconsistency of island constraints in Korean UDCs cannot be supporting evidence for semantic binding approaches to Korean. In addition to syntactic connectivity, semantic binding relations between a UDC gap and a constituent are tighter than other binding relations between a pronoun and its antecedent. In the next section, we will examine strong crossover and coordination facts that distinguish the filler-gap linkage of Korean UDC gaps from semantic binding. Then, later in this paper we will provide a syntactic representation of unbounded dependencies with a simple syntactic tool, which avoids all the problems of island constraint violations that the movement approaches have confronted.

## 4 Characterizing Properties of Korean UDC Gaps

### 4.1 Strong Crossover

The Strong Crossover (SCO) Constraint does not apply to *pros* in general, as we see in (3).

- (3) [ John<sub>i</sub>-un [ e<sub>i</sub> [ Mary-ka ku<sub>i</sub>-eykey [ pro<sub>i</sub> kayahanta-ko]  
       John-TOP       Mary-NOM he-to                   must go-COMP  
       malhayssta-ko] kiekhanta].  
       told-COMP       remember  
       ‘As for John<sub>i</sub>, (he<sub>i</sub>) remembers that Mary<sub>j</sub> told him<sub>i</sub> that (e<sub>i</sub>) must go.’

In(3), *e<sub>i</sub>* represents a gap directly linked to its antecedent in the position of topic. It contrast with a *pro* that appears in the most deeply embedded clause. In general,

*pros* in Korean occur when their coreferential elements (antecedents) are introduced in the previous context or when their coreferential elements syntactically precede. The *pro<sub>i</sub>* takes the preceding pronoun *ku<sub>i</sub>* as its antecedent and refers to *John* in (3). This violates the SCO constraint. In contrast with *pros*, UDC gaps observe the SCO constraint, as in the following example.

- (4) \* *ku ai<sub>i</sub>-nun Mary-ka ku papo<sub>i</sub>-eykey [e<sub>i</sub>/ku<sub>i</sub>/caki<sub>i</sub>-lul cal*  
 that child-TOP Mary-NOM that idiot-to /he-/selfACC well  
*tolpokessta-ko] yaksokhayssta.*  
 take care-COMP promised  
 ‘As for the child<sub>i</sub>, Mary promised that idiot<sub>i</sub> to take care of him<sub>i</sub> well.’

The example (4) shows that SCO is observed for UDCs. Instead of a pronoun an epithet has been used in (4). It is because the use of pronoun *ku* may allow a resumptive pronoun analysis of the intervening pronoun, which follows Vaillette (2001). In order to examine the applicability of crossover to Hebrew RPs, Vaillette (2001) replaces the upper pronoun by an epithet. The epithet has the same index value as the antecedent, while it retains an independent lexical meaning. Although (what looks like) pronouns and reflexives can be audible (SLASH-bearing) traces, epithets cannot be. Thus, the same strategy can be applied to Korean.

A notable point is that resumptive pronominal elements in Korean UDCs observe the SCO constraint as do inaudible traces. This fact is problematic because previous literature has assumed that SCO violations are triggered by the status of UDC gaps; in general UDC gaps are nonpronominal elements or R(eferring)-expressions. However, RPs in Korean UDCs show the same SCO effects as non-pronominal gaps in spite of their pronominal status. Within Chomskyan approaches, the SCO effects are accounted for by Principle C that requires so-called R-expressions to be unbound. Similarly, within the framework of HPSG, the SCO phenomenon has been explained by the binding condition C that specifies that a nonpronoun must be o-free. However, Postal (2004) argues that the SCO phenomenon in English cannot be accounted for by Chomsky’s Principle C, and based on his arguments it is hard to argue that SCO effects are attributed to the status of UDC gaps as non-pronominal elements.<sup>1</sup> The SCO effects in Korean UDCs are not associated with Principle C (or condition C in HPSG). This argument is supported by the following examples.

---

<sup>1</sup>Postal (2004) points out that the SCO effect cannot be reduced to Chomsky’s Principle C that bars anaphoric linkage between pronoun and the nonpronominal trace based on (i) existence of SCO effects in non-NP extraction, (ii) the secondary strong effect, (iii) the Asymmetry Property and (iv) failure of the c-command condition required for Principle C. He claims that even though the Principle C account of the SCO effect is often considered to be supporting evidence of traces as nonpronominal R-expressions, there is no empirical evidence for any trace-like objects connected with extraction.

- (5) a. ku ai<sub>i</sub>-nun wuli-ka [<sub>ADVP</sub> John<sub>k</sub>-ul thonghay-se] [<sub>S</sub> e<sub>i</sub> iphak  
the kid-TOP we-NOM John-ACC mediate-by entrance  
sihem-ey hapkyekhayss-um-ul] alkey toyessta.  
exam-at pass-NML-ACC know became  
(lit.) ‘As for the kid<sub>i</sub>, we got to know via John that (he<sub>i</sub>) passed the entrance exam.’
- b. \*ku ai<sub>i</sub>-nun wuli-ka [<sub>ADVP</sub> ku papo<sub>i</sub>-lul thonghay-se] [<sub>S</sub> e<sub>i</sub>  
the kid-TOP wuli-NOM that idiot-ACC mediate-by  
iphak sihem-ey hapkyekhayss-um-ul] alkey toyessta.  
entrance exam-at pass-NML-ACC know became  
(lit.) ‘As for the kid<sub>i</sub>, we got to know via that idiot<sub>i</sub> that (he<sub>i</sub>) passed the university exam.’
- c. \*ku ai<sub>i</sub>-nun wuli-ka [<sub>ADVP</sub> ku papo<sub>i</sub>-lul thonghay-se] [<sub>S</sub>  
that child-TOP we-NOM that idiot-ACC mediate-by  
ku<sub>i</sub>-ka iphak sihem-ey hapkyekhayss-um-ul] alkey toyessta.  
he-NOM entrance exam-at pass-NML-ACC know became  
(lit.) ‘As for the kid<sub>i</sub>, we got to know via that idiot<sub>i</sub> that he<sub>i</sub> passed the entrance exam.’

In the given examples, the intervening epithets are located in adjunct phrases that do not c-command (or o-command) the gaps in the embedded phrases. Although no violation of Principle C (or condition C) can be induced in (5), anaphoric linkage between a filler and a gap is as impossible as in (5b) and (5c). Moreover, when a gap appears in an adverbial phrase of the embedded clause, the SCO effects still appear in spite of the failure of c-command between a pronoun or an epithet and its anaphoric gap. In (6b), topicalization is licensed and there is no c-commanding relation between the gap and its antecedent. However, the antecedent in an adjunct cannot be topicalized as in (6c) and (6d) when there is an intervening pronoun or an epithet. This contrasts with (6b).

- (6) a. ?\* Nay-ka ku/ku papo<sub>j</sub>-eykey [[ John<sub>j</sub>-i pwucilenhay-se] cip-ey  
I-NOM he/that idiot-to John-NOM diligent-because home-at  
menci-to hana epsta-ko] cenhaysse.  
dirt-also single not exist-COMP told  
‘I told him<sub>j</sub>/that idiot<sub>j</sub> that there is no dirt at home because (he<sub>j</sub>) is diligent.’
- b. John<sub>j</sub>-un nay<sub>j</sub>-ka saramtul<sub>k</sub>-eykey [[ e<sub>j</sub> pwucilenhay-se] cip-ey  
I-NOM he/that idiot-to diligent-because home-at  
menci-to hana epsta-ko] cenhaysse.  
dirt-also single not exist-COMP told  
‘As for John<sub>j</sub>, I told people<sub>k</sub> that there is no dirt because (he<sub>j</sub>) is diligent.’



- c. ?\* John<sub>j</sub>-un nay-ka ku/ku papo<sub>j</sub>-eykey [[ e<sub>j</sub> pwucilenhay-se] cip-ey  
 John-TOP I-NOM he/that idiot-to diligent-because home-at  
 menci-to hana epsta-ko] cenhaysse.  
 dirt-also single not exist-COMP told  
 ‘As for John<sub>j</sub>, I<sub>i</sub> told him<sub>j</sub>/that idiot<sub>j</sub> that there is no dirt at home because  
 (he<sub>j</sub>)is diligent.’
- d. ?\* John<sub>j</sub>-un nay<sub>i</sub>-ka ku/ku papo<sub>j</sub>-eykey [[ ku<sub>j</sub>-ka pwucilenhay-se]  
 John-TOP I-NOM he/that idiot-to he-NOM diligent-because  
 cip-ey menci-to hana epsta-ko] cenhaysse.  
 home-at dirt-also single not exist-COMP told  
 ‘As for John<sub>j</sub>, I<sub>i</sub> told him<sub>j</sub>/that idiot<sub>j</sub> that there is no dirt at home after he<sub>j</sub> is  
 diligent.’

Based on the fact that a pronoun and its anaphoric element do not hold a c-command (or o-command) relation, we conclude that SCO effects in Korean UDCs cannot be reduced to Principle C in GB theory or condition C in HPSG. Thus, there is no factual support for the status of traces as nonpronominal elements, which is why the SCO constraint is observed by both RPs and inaudible traces in Korean UDCs. This accords with SCO effects in English as shown in Postal (2004). An RP can be represented in HPSG via the propagation of a non-local feature. In addition to an RP, the long distance reflexive *caki* ‘self’ can also appear in the position of the trace.

## 4.2 Coordination

In general, it has been argued that the Coordinate Structure Constraint (CSC) is observed in Korean coordinate structures. The constraint disallows asymmetric extraction out of one conjunct. For example, (7b) and (7c) are ungrammatical because only one conjunct has a missing element. However, (7a) is grammatical because the topicalized element is connected to the missing elements in both conjuncts.

- (7) a. i chayk<sub>j</sub>-un [ aitul-i e<sub>j</sub> cohaha-ko eluntul-to e<sub>j</sub> chohahay].  
 this book-TOP kids-NOM like-CONJ adults-also like  
 ‘As for this book<sub>j</sub>, kids like (it<sub>j</sub>) and adults also like (it<sub>j</sub>).’
- b. \*i chayk<sub>j</sub>-un [ aitul-i e<sub>j</sub> cohaha-ko eluntul-i manhwachayk-ul  
 this book-TOP kids-NOM like-CONJ adults-NOM comic book-ACC  
 silehay].  
 like  
 ‘As for this book<sub>j</sub>, kids like (it<sub>j</sub>) and adults dislikes comic books.’
- c. \*i chayk<sub>j</sub>-un [ aitul-i manhwachayk-ul cohaha-ko elun-i  
 this book-TOP kids-NOM comic books-ACC like-CONJ adults-NOM  
 e<sub>j</sub> chohahay].  
 like  
 ‘As for this book<sub>j</sub>, kids like comic books and adults dislike (it<sub>j</sub>).’

Another fact related to coordination is that a gap in a conjunct is allowed when there is a gap in the other conjunct, or a pronoun, as in (8a) and (8b).

- (8) a. i chayk<sub>j</sub>-un [aitul-i kukes<sub>j</sub>-ul acwu cohaha-ko nointul-to  
 this book-NOM kids-NOM it-ACC very like-CONJ old people-also  
 e<sub>j</sub> congcong chassnunta]  
 often ask for  
 ‘As for this book<sub>j</sub>, kids like it<sub>j</sub> very much and old people also buy (it<sub>j</sub>) often.’
- b. i chayk<sub>j</sub>-un [aitul-i e<sub>i</sub> acwu cohaha-ko nointul-to  
 this book-NOM kids-NOM very like-CONJ old people-also  
 kukes<sub>j</sub>-ul congcong chassnunta]  
 it-ACC often ask for  
 ‘As for this book<sub>j</sub>, kids like (it<sub>j</sub>) very much and old people also ask for (it<sub>j</sub>).’

In particular, the example (8b) shows that the gap in the first conjunct is a trace but not a *pro*. It is supported by the general fact that in Korean a *pro* is not allowed to appear in the first conjunct of coordinated structures.

Given that the CSC operates in Korean UDCs to require a gap in each conjunct and given that the pronominal *kukes* in a conjunct does not cause a violation of the CSC, as in (8a) and (8b), we can argue that those pronouns are RPs and that they behave in the same way as traces. Thus, this favors the UDC approach to RPs.

In summary, we argue that the pronouns appearing in the gap positions are not *pros*. Instead, we argue that RPs in the gap position work as audible traces. According to the trace approach, RPs and gaps arise from a single mechanism. This argument is crosslinguistically compatible with Georgopoulos (1991) and Vaillette (2001) with respect to Palauan and Hebrew. The terms for UDC gaps and non-UDC correspondents in Korean are summarized in the following chart. The UDC elements in the left-hand column all triggers a nonzero SLASH feature while the right-hand column cannot.

(9)

	UDCs	non-UDCs
zero	trace	<i>pro</i>
overt	resumptive prn	(ordinary) prn
<i>caki</i>	resumptive refl	(ordinary) refl

## 5 The Analysis of RPs and RR *caki*

Korean UDCs always involve the presence of one of three elements that give rise to a nonlocal SLASH feature: trace, resumptive pronoun, and resumptive reflexive. These three elements have certain properties with respect to the SCO constraint and coordination. Each of them shares certain information with a filler that appears in a possibly distant higher node. Furthermore, they share certain properties in common

with their corresponding forms in non-UDCs. The occurrences of the reflexive *caki* are associated with semantic and pragmatic properties of logophoricity and contrastiveness, in contrast with neutral occurrences of pronouns. This suggests that resumptive elements in UDCs are the same entities as those in non-UDCs except that the LOCAL feature of the former is the value of the SLASH feature percolating into higher structure. Based on common properties of logophoricity and contrastiveness, we claim that RPs and the RR *caki* in UDCs are respectively the same elements of pronouns and the LD reflexive *caki* in non-UDCs. In other words, resumptive elements in UDCs belong to the same sort hierarchy as non-UDC correspondents.

### 5.0.1 Logophoricity

The role of logophoricity in the interpretation of nonsyntactic reflexives has been widely discussed in the previous literature (e.g. Sells (1987), Pollard and Xue (2001), etc.). According to Sells (1987), logophoricity refers to subject of consciousness (SELF), the source of reported speech (SOURCE), and deictic perspective (PIVOT). Based on Sell's notion of logophoricity, the antecedent of the LD reflexive *caki* is logophoric in the following examples.

- (10) a. Mira<sub>i</sub>-ka [ Yumi-ka caki<sub>i</sub>/kunye<sub>i</sub>-lul chotayhayse] kipputa.  
 Mira-NOM Yumi-NOM self<sub>i</sub>/her<sub>i</sub>-ACC invite-because be glad  
 'Mira<sub>i</sub> is glad because her<sub>i</sub> son entered a university.'
- b. Mira<sub>i</sub>-ka [ Yumi-ka \*caki<sub>j</sub>/kunye<sub>j</sub>-lul chotayhayse] Jisu<sub>j</sub>-ul  
 Mira-NOM Yumi-NOM self<sub>j</sub>/her<sub>j</sub>-ACC invite-because Jisu-ACC  
 pwulewehanta.  
 envied  
 'Mira<sub>i</sub> envies Jisu<sub>j</sub> because Yumi<sub>k</sub> invited her<sub>j</sub>'

In (10a), both reflexive *caki* and pronoun *kunye* are bound by the long-distance antecedent *Mira* that is the subject of consciousness. However, in (10b) it cannot be bound by the object *Yumi* because *Yumi* is not the subject. While *caki* takes the center of consciousness as its antecedent, the pronoun binding is not related to logophoricity. Instead, the pronoun use in (10) implies that the speaker takes an objective or 3<sup>rd</sup>-person point of view in describing the proposition. Using the reflexive *caki* implies that the viewpoint of the sentence is based on the subject of consciousness, and Sells (1987) names this notion as SELF.

The same kind of logophoric properties can be found in UDCs.

- (11) a. [ caki<sub>i</sub>-ka silswu ha-n] namca<sub>i</sub>-ka ohilye hwa-lul  
 self-NOM mistake make-REL man-NOM ironically anger-ACC  
 nayssta.  
 expressed  
 'The man<sub>i</sub> who he<sub>i</sub> made a mistake got angry ironically.'

- b. \* *nay-ka* [ *caki<sub>i</sub>-ka silswu ha-n*] *namca<sub>i</sub>-lul yatanchyessta.*  
 I-NOM self-NOM mistake make-REL man-ACC scolded  
 ‘I scolded the man<sub>i</sub> who he<sub>i</sub> made a mistake.’

In (11a), the antecedent *namca* works as SELF and binds *caki* in the gapped position. In (11b), it is not SELF and does not bind *caki*.

Logophoricity is related to certain predicates such as verbs of communication, psych-predicates, etc. In particular, a psych-predicate experiencer is logophoric because the predicate reports the state of consciousness of the experiencer. Consider the following examples.

- (12) a. [ *John<sub>i</sub>-i* [ *caki<sub>j</sub>/kunye<sub>j</sub>-lul salanghanta-ko*] *malha-n*] *sasil-i*  
 John-NOM self/she-ACC love-COMP said-REL fact-NOM  
 Mary<sub>i</sub>-eykey *pwutamsulewessta.*  
 Mary-to burdensome  
 ‘The fact that John<sub>i</sub> said that (he<sub>i</sub>) loves her<sub>i</sub> was burdensome to Mary<sub>i</sub>.’
- b. *Mina<sub>i</sub>-ka* [ *John<sub>k</sub>-i* [ \**caki<sub>j</sub>/kunye<sub>j</sub>-lul salanghanta-ko*]  
 Mina-NOM John-NOM self/her-ACC love-COMP  
*malhay-se*] *Mary<sub>j</sub>-lul miwehanta .*  
 said-because Mary-ACC hate  
 ‘Since John<sub>k</sub> told Mina<sub>i</sub> that (he<sub>k</sub>) loves Mary<sub>j</sub>, she<sub>i</sub> hates her<sub>j</sub>.’

In (12a), the experiencer NP of the psych-predicate *pwutamsulepta* is interpreted as an antecedent of *Mary* (Backward binding is allowed). However, in (12b) *caki* cannot be bound by the object antecedent that is not SELF. Pronouns, however, can be bound by antecedents that appear as an Experiencer argument and by the object in (12a) and (12b).

In Korean, logophoricity seems to be related to the thematic roles Agent and Experiencer. The antecedent of reflexive *caki* is interpreted either as an individual who plays the central role performing an action or as an experiencer going through a particular physical or psychological process. An experiencer argument is not restricted to psych-predicates. It plays a more active role in the event structure described by the main predicate compared to other arguments of theme, goal, and source. With respect to reflexive binding, an Experiencer NP can be an antecedent of *caki* as we see in the following examples.

- (13) *Mary<sub>i</sub>-ka Yumi<sub>j</sub>-eykey* [ *caki<sub>i/j</sub> cip-ey ka-key*] *hayssta.*  
 Mary-NOM Yumi-to self house-to go-ACC made  
 ‘Mary<sub>i</sub> made Yumi<sub>j</sub> her<sub>i/j</sub> book to Yumi<sub>j</sub>.’
- (14) *Jinwoo<sub>j</sub>-eykey* [ *caki<sub>i/j</sub>-ka sihem-ey hapkyekhass-um-i*] *mitkici*  
 Jinwoo-to self-NOM exam-to pass-ing-NOM be believed  
*ahassta.*  
 not-COMP  
 ‘It was not believed to Jinwoo<sub>j</sub> that he<sub>i/j</sub> passed the exam.’

In (13) and (14), the reflexive *caki* can be bound by the dative NPs. Dative NPs can be interpreted as a sort of Experiencer that goes through a certain event or a psychological process. In addition, if the verb specifies a certain situation, then the dative NP can be the preferred antecedent of *caki*. For example, if the verb *tolakata* (go back) is used instead of *kata* as the embedded predicate, then the Experiencer antecedent is preferred in (13). Thematic roles of Agent and Experiencer share certain semantic entailments with respect to the event structure of the main verb. Those common properties can be captured by the notion of Proto-Agent role as suggested by Lee (1999). Lee (1999) uses the Proto-role analysis of Dowty (1991) for case marker realization in Korean and argues that an experiencer argument in Korean has strong Proto-Agent properties. Proto-Agent properties of an argument in Dowty (1991) are based on lexical entailments of a verb. They include volitional involvement in the event or state, sentience/perception, causing an event or change of state in another participants, and movement relative to the position of another participant. An argument with more Proto-Agent properties tends to be realized as the subject in many languages. We can account for the fact that Experiencer elements appearing with case marker *eykey* or with psych-predicates work as antecedents of *caki* in Korean since they are known to retain Proto-Agent entailments. Proto-Agent properties seem to be related to logophoricity. In other words, an argument with more Proto-Agent properties is easily considered as SELF.

### 5.0.2 Contrastiveness

Reflexive *caki* is associated with the meaning of discourse prominence or contrastiveness. *caki* is used when its antecedent shows contrastiveness with other discourse entities. Consider the following examples.

- (15) Mira-ka talum salamtul-eykey-nun kwantayha-myense,  
 Mira-NOM other people-to-CTOP generous-while  
 caki<sub>i</sub>/<sup>?</sup>\*kunye<sub>i</sub>-ekye-nun emhata.  
 self/she-CTOP strict  
 ‘Mira<sub>i</sub> is generous to other people while she<sub>i</sub> is strict about herself<sub>i</sub>.’
- (16) John<sub>i</sub>-i [ caki<sub>i</sub>/<sup>?</sup>\*ku-nun mwusiha-myense hyeng-un  
 John-NOM self/he-CTOP ignore-while brother-CTOP  
 chingchanha-nun] apeci-ka miwessta.  
 praise-REL father-ACC hate  
 ‘John<sub>i</sub> hates his father, who is ignoring him<sub>i</sub> while praising his brother.’

In (15), Mira’s attitude toward others contrasts with her attitude toward herself. Here, *nun/un* are contrastive topic markers (CTOP). In (16), the father’s behavior with one son contrast with his behavior with another. Contrastive topic markers are attached to two contrasting NPs and are differentiated from topic markers attached to topicalized elements in sentence initial position. In the context of a contrastive

interpretation, reflexive *caki* is licensed, while a pronoun is not. In (16), John's attitude toward others is opposite of that toward him.<sup>2</sup> The contrastiveness of the reflexive *caki* is frequently found in topic and relative constructions, where its antecedents play a contrastive role with others.<sup>3</sup>

- (17) [ emeni-ka hyeng-eykey-nun senmul<sub>j</sub>-ul cwumyense  
 mother-NOM brother-to-CTOP gift-ACC give-while  
 caki<sub>i</sub>/<sup>?</sup>ku<sub>i</sub>-eykey-nun senmwul-ul cwuci ahn-un] ai<sub>i</sub>  
 self/he-to-CTOP gift-ACC give did not-REL kid  
 'the kid<sub>i</sub> whose mother did not gave a present to him<sub>i</sub> while she gave it to his  
 bother.'
- (18) Mira<sub>i</sub>-nun [ talun aitul-un motu ttetulesciman caki/<sup>?</sup>\*kunye<sub>i</sub>-nun  
 Mira-TOP other kids-CTOP all was noisy-END self/she-CTOP  
 chimmwuk-ul cikyessta].  
 quite kept  
 'As for Mira<sub>i</sub>, although other kids<sub>j</sub> were all noisy, she<sub>i</sub> kept quite.'

As in (17) and (18), when the contrastive meaning is distinct, the occurrence of *caki* is more natural than that of an RP. In particular, when the sentence has a comparative meaning as in (18), the resumptive element is realized in terms of the RR *caki* rather than the RPs.

Given that RR *caki* and RPs show the same characteristics with respect to logophoricity and contrastiveness, both in non-UDCs and UDCs, we conclude that these elements are the same objects. This approach is reminiscent of Pollard and

<sup>2</sup>A pronoun and long-distance 'caki' can be licensed in the same position although they deliver different focus interpretations.

- (i) a. Minwoo<sub>i</sub>-ka kyosil-ey tule o-nun John<sub>j</sub>-ul po-ca, caki<sub>i</sub>/<sup>\*</sup>j-ka  
 Minwoo-NOM classroom-to enter come-REL John-ACC see-when self-NOM  
 insa-lul hayssta.  
 greeting-ACC did  
 'When Minwoo saw John, who came into the classroom, he<sub>i</sub> (but not John) greeted (to him).'
- b. Minwoo<sub>i</sub>-ka kyosil-ey tule o-nun John<sub>j</sub>-ul po-ca, ku<sub>i</sub>/<sub>j</sub>-ka insa-lul  
 Monwoo-NOM classroom-to enter come-REL John-ACC see-when he-NOM greeting-ACC  
 hayssta.  
 did  
 'When Minwoo saw John, who came into the classroom, he<sub>i</sub> greeting (to him) first.'

In (ia), the implication is that it was *Minwoo* but not *John* who performed the act of greeting. This separates *Minwoo* from other discourse participants so the focus is on *Minwoo*. However, (ib) does not imply any contrast between *Minwoo* and others.

<sup>3</sup>Pollard and Xue (2001) point out that contrastiveness signified by pitch accent or by lexical/structural marking makes a nonsyntactic use of Chinese reflexive *ziji* (more) acceptable. This seems to be the case in Korean too.

Xue (1998, 2001) who pointed out that a distinction between structural and discourse binding should not be treated as lexical ambiguity. Instead, they proposed one type of *reflexive*, which can be either syntactically bound or pragmatically bound or both simultaneously. One their view, there is no notion of obligatory binding for reflexives in Chinese or in American English; rather, reflexives are subject to nonexclusive constraints of syntactic binding or discourse binding. We agree with them because the distinction between syntactic and nonsyntactic uses of reflexives can be captured simply in their theory without introducing lexical ambiguity and its redundant complications. Although Pollard and Xue (1998, 2001) do not consider resumptive pronouns, their combinatoric approach seems to be properly applied for a general realization of the RR *caki* in UDCs and the LD reflexive *caki* in non-UDCs in Korean. In addition, RPs in UDCs maintain the same sort of constraints in non-UDCs and UDCs, too. The only extra property of these elements is that they license a non-local feature that percolates upper phrasal categories in UDCs.

## 6 Conclusion

In this paper, we have provided SCO and coordination facts to support nonlocal feature propagation for RPs in Korean. Unlike Hebrew RPs, Korean RPs show inconsistent behavior with respect to island constraints; some of them are sensitive to island constraints while others are not. Thus, it is hard to provide a syntactic account for island constraints. Unbounded dependencies represented by traces, RPs, and the RR *caki* can be simply captured - without posing any extra mechanisms - in the traditional HPSG analysis of UDCs following Pollard and Sag (1994). In HPSG, traces are not all required to have the same features. In Korean UDCs, local values of traces, RPs, and the RR *caki* can originate the nonlocal SLASH feature. The three kinds of UDC elements appearing in gap positions do not form separate categories from their corresponding forms appearing in non-UDCs. In other words, *pros*, overt pronouns, and the LD reflexive *caki* work in UDCs as inaudible traces, RPs, and the RR *caki* so that they are required to be semantically and syntactically bound by the nonlocal TO-BIND|SLASH feature.

In sum, Korean UDCs always involve the presence of one of three elements that give rise to a nonlocal SLASH feature: trace, resumptive pronoun, and resumptive reflexive. These three elements have certain properties with respect to the SCO constraint and coordination. Each of them shares certain information with a filler that appears in a possibly distant higher node. Furthermore, they share certain properties in common with their corresponding forms in non-UDCs.

Our UDC approach is different from accounts of Chomsky's minimalist program and GB theory, where all traces are considered to be the same category.<sup>4</sup> Chomsky's binding theory requires that fillers be reconstructed to the trace posi-

---

<sup>4</sup>Within GB theory, noun phrases are classified by the two binary features, a(naphoric) and p(ronominal), and all traces are assumed to be R-expressions with -a and -p features.

tion before binding conditions are applied. Within this kind of approach, it is hard to capture the fact that RPs and RR *caki* work as traces. The HPSG system makes three different kinds of traces possible and captures the fact that traces, RPs, and the RR *caki* in UDCs belong respectively to the subset of *pros*, pronouns, the LD reflexive *caki* in non-UDCs. In addition, our trace analysis of resumptive elements casts some doubt on traceless approaches proposed by Sag (1997) and Kim (1998). According to their traceless analyses, gap information is encoded in the lexical entry of a predicate without involving a structural position for an empty category. However, resumptive elements that trigger the SLASH feature need to appear in syntactic structures. Thus, the existence of audible correspondents of traces supports the traditional HPSG analysis of Pollard and Sag (1994), which assumes an empty category in a given syntactic structure. One way that a non-local dependency can be bound off is for a local tree to instantiate the filler-gap schema. In line with Levine et al. (2001)'s unitary analysis of English parasitic gaps, we argue that the non-local feature specification can be used to account for different kinds of Korean UDCs.

## References

- Chae, Hee-Rahk. 1998. A Comparative Analysis of *Tough*- and Comparative Constructions in English and Korean. *Language Research* 34-1, 33–71.
- Cole, Peter. 1987. Null Objects in Universal Grammar. *Linguistic Inquiry* 18-4, 597–612.
- Dowty, David. 1991. Proto-roles and Argument Selection. *Language* 67, 547–619.
- Georgopoulos, Carol. 1991. *Syntactic Variables: resumptive pronouns and A' binding in Palauan*. Dordrecht: Kluwer.
- Huang, Cheng-Teh James. 1984. On the Distribution and Reference of Empty Pronouns. *Linguistic Inquiry* 15-4, 531–574.
- Hukari, Thomas and Levine, Robert. 1995. Adjunct Extraction. *Journal of Linguistics* 31, 195–226.
- Kang, Young-Se. 1986. *Korean Syntax and Universal Grammar*. Ph. D.thesis, Harvard University, Cambridge, MA.
- Kim, Jong-Bok. 1998. A Head-Driven and Constraint-Based Analysis of Korean Relative Clause Constructions. *Language Research* 34.4, 1–41.
- Lee, Sun-Hee. 1999. *Korean Accusative Case -lul and Its Grammatical Realization*. Ph. D.thesis, Yonsei University, Seoul, Korea.



- Levine, Robert, Hukari, Thomas and Calcagno, Michael. 2001. Parasitic Gaps in English: Some Overlooked Cases and Their Theoretical Implications. In Peter Culicover and Paul Postal (eds.), *Parastic Gaps*, pages 181–222, Cambridge, MA: MIT Press.
- Pollard, Carl and Sag, Ivan A. 1994. *Head-driven Phrase Structure Grammar*. Chicago: The University of Chicago Press.
- Pollard, Carl and Xue, Ping. 1998. Chinese Reflexive *ziji*: Syntactic reflexive vs. nonsyntactic reflexives. *Journal of East Asian Linguistics* 7, 287–318.
- Pollard, Carl and Xue, Ping. 2001. Syntactic and Nonsyntactic Constraints on Long-distance Reflexives. *Syntax and Semantics* 33, 317–342.
- Postal, Paul M. 1994. Contrasting Extraction Types. *Journal of Linguistics* 30, 159–186.
- Postal, Paul M. 2004. *Skeptical Linguistic Essays*. New York, NY: Oxford University Press.
- Sag, Ivan. 1997. English Relative Constructions. *Journal of Linguistics* 33, 431–494.
- Sells, Peter. 1987. Aspects of logophoricity. *Linguistic Inquiry* 18, 445–479.
- Szabolcsi, Anna and den Dikken, Marcel. 1999. Islands. *GLOT International* 4-6, 3–9.
- Vaillette, Nathan. 2001. Hebrew Relative Clauses in HPSG. In D. Flickinger and A. Kathol (eds.), *The Proceedings of the 7th International Conference on Head-Driven Phrase Structure Grammar*, CSLI.

# An HPSG approach to the *who/whom* puzzle

Takafumi Maekawa

University of Essex

Proceedings of the 12th International Conference on  
Head-Driven Phrase Structure Grammar

Department of Informatics, University of Lisbon

Stefan Müller (Editor)

2005

Stanford, CA: CSLI Publications

pages 290–310

Maekawa, Takafumi. 2005. An HPSG approach to the *who/whom* puzzle. In Stefan Müller (ed.), *Proceedings of the 12th International Conference on Head-Driven Phrase Structure Grammar, Department of Informatics, University of Lisbon*, 290–310. Stanford, CA: CSLI Publications. DOI: 10.21248/hpsg.2005.16. 

## Abstract

Order domains were originally proposed to deal with constituent order, but have recently been concerned with more than just linearization. This paper seeks to contribute to this discussion by considering the possibility of analysing word forms in terms of order domains. We focus on the distribution of the English relative and interrogative pronouns *who* and *whom*. It is shown that a small number of constraints can accommodate the seemingly complex body of data. In particular, a linearization-based constraint can provide a straightforward account for the quite puzzling distribution which *who* and *whom* show in one of the register types.

## 1 Introduction

Within Head-Driven Phrase Structure Grammar (henceforth, HPSG), recent years have seen the emergence of a view in which linear order is independent to a considerable extent from constituency and is analysed in terms of a separate level of ‘order domains’.\* This approach has begun to provide promising analyses of a variety of linearization phenomena (e.g., Pollard et al. 1994; Reape 1994; and Kathol 2000). More recently, order domains have been concerned with more than just linearization: e.g., Yatabe (2001; semantic composition), Borsley (2005; Welsh agreement), Yoshimoto (2000, 2003; phonology), Jaeger (2003) and Maekawa (2004; information structure). In this paper we would like to contribute to this discussion by considering the possibility of analysing certain word forms in terms of order domains. The empirical domain which we will be focusing on is the English interrogative/relative pronouns *who* and *whom*.

It has been traditionally accepted as a prescriptive rule that *who* is the form for a subject and subject complement and *whom* is the form for a verbal or prepositional object. This rule would require that *who* should be employed in the following sentences.

---

\* I would like to thank Bob Borsley for his valuable comments and discussions. Thanks are also due to the participants at HPSG 2005 for their feedback and discussions. I am also grateful to three anonymous reviewers for HPSG 2005 and the participants at the Constraint Based Linguistics in the South of England meeting on 1 April 2005 at University of Essex for their comments and discussions on earlier versions of this paper. Any shortcomings are my responsibility. I gratefully acknowledge the generous financial assistance from the Department of Language and Linguistics, University of Essex.

- (1) a. *Who/\*whom* wrote the editorial?  
 b. the man *who/\*whom* came to dinner

In (1) *who* is a subject of the following finite verb, and therefore *whom* is prohibited. The prescriptive rule would also require the occurrence of *who* in the following examples.

- (2) a. We feed children *who/\*whom* we think are hungry.  
 b. the man *who/\*whom* I believe has left.  
 c. the man *who/\*whom* it was believed had left.

In (2) *who* is a subject of the lower clause, so *whom* is excluded.

With regard to non-subject positions, however, there is an alternation between *who* and *whom*. As illustrated by the following examples, *whom* alternates with *who* as object of a verb or preposition in main clauses (3), embedded clauses (4), and in situ (5). The prescriptive rule would predict the occurrence of *whom*, not *who*, in these contexts.

- (3) a. those *whom/who* we consulted.  
 b. someone *whom/who* we can rely on  
 c. He didn't say *whom/who* he had invited.
- (4) a. *Whom/who* did you meet?  
 b. *Whom/who* are you referring to?
- (5) a. Who will marry *whom/who*?  
 b. Who is buying a gift for *whom/who*?  
 c. It was *whom/who*?<sup>1</sup>

The important point that we should note is that the prescriptive rule only works in the formal register. In the informal register, speakers do not stick to this rule and they use *who* in any syntactic environment. This would predict the occurrence of *whom* and the impossibility of *who* in (6).

- (6) a. To *whom/\*who* are you referring?  
 b. someone on *whom/\*who* we can rely

---

<sup>1</sup> The copular verb *be* requires an accusative complement, except for the formulaic use of nominative as in *It was I*.

- (i) a. In this picture, the person in the purple shorts is me/\*I.  
 b. It was just us/\*we

See Sobin (1997) and Lasnik and Sobin (2000) for details.

In (6), *who/whom* is in the complement position of a fronted PP. The impossibility of *who* in this position will be able to be attributed to the fact that this kind of construction, i.e., pied-piping, is confined to the formal register. Given that the construction itself is in the formal register, the prescriptive rule captures the occurrence of *whom* in (6) since it is a prepositional object.

Thus, if we assume separate rules for the formal and the informal register, we can keep the prescriptive rule for the formal register; for the informal register, *who* is the only available form.

There is, however, a striking fact about the formal register: for many speakers, the distribution of *who* and *whom* does not conform to the prescriptive rule. They allow an alternation of *who* and *whom* for the subject of the lower clause in (2).

- (7) a. We feed children *who/whom* we think are hungry.  
b. the man *who/whom* I believe has left.  
c. the man *who/whom* it was believed had left.

As we noted above, the prescriptive rule would predict only the occurrence of *who* in such a syntactic environment. It seems that not all native speakers of English accept this use of *whom*; for example, Quirk et al (1985: 368) cites the following example as hypercorrection.

- (8) \* The ambassador, *whom* we hope will arrive at 10 a.m., ...

They also mention, however, that this kind of use of *whom* is ‘common’ (1985: 368), and it is indeed acceptable for many English native speakers.<sup>2</sup> In these sentences *whom* occurs in a position where its source is the subject of a lower finite clause. If we just assumed the above prescriptive rule for the formal register, it would lead to the wrong prediction that *who* is the only form that appears in such a syntactic context. A satisfactory analysis of the *who/whom* distinction in the formal register should be able to ensure that some native speakers of English accept *whom* and others reject it in (7); the latter category can be said to manage to conform to the prescriptive rule.

As has been clear, the behaviour of *who/whom* appears to be rather complex. In section 2, however, we will show that if we distinguish three

---

<sup>2</sup> See Jespersen (1924; 1927), Swan (1995), Lasnik and Sobin (2000), Huddleston and Pullum (2002), etc.

separate register types, that is, informal type, prescriptive type, and non-prescriptive type, the apparent complexity of the data is restricted to just non-prescriptive type, and *who/whom* in the other two types show a rather straightforward behaviour. Section 3 will show that the general framework of HPSG can accommodate the *who/whom* distinction in the informal and prescriptive types without any additional theoretical apparatus beyond those proposed in previous work. In section 4 it will be shown that a linearization-based constraint can provide a straightforward account for the quite puzzling distribution which *who* and *whom* show in the non-prescriptive type. Lasnik and Sobin's (2000) analysis within Virus Theory will be discussed and compared with our HPSG analysis in section 5. Section 6 is the conclusion.

## 2 Three types of register

On the basis of the observation so far, the distribution of *who* and *whom* can be summarised as in (9).

(9) Distribution of *who* and *whom* by register type

Environments	Formal		Informal
	non-prescriptive	prescriptive	
Obj in a fronted PP	<i>whom</i>	<i>whom</i>	N/A
Non-subj in embedded clauses			
Non-subj in main clauses			
Non-subj in situ			
Subj of a lower clause			
Subj of the first following V	<i>who</i>	<i>who</i>	<i>who</i>

We assume that there are two registers: formal and informal. We further assume that there are two types for the formal register: the prescriptive type and the non-prescriptive type. Thus we have three types of register: prescriptive, non-prescriptive and informal. (9) makes it clear that each of the three register types has its own version of the *who/whom* distribution. The informal register employs *who* in every syntactic environment except for the object position of a fronted PP.

In the prescriptive type of formal register, *whom* is employed in all the non-subject contexts and *who* is employed for subjects, whichever clause it is originated from, the upper or the lower clause (i.e., (1) and (2)). What we should note here is that for this type the choice of *who* works in the same way as assignment of nominative case; any theory of filler-gap dependencies would predict that a filler associated with a gap in the lower clause has the case that is assigned to the position of the gap.

Turning to the non-prescriptive type, *whom* is employed in all cases except where a filler is the subject of the first following V: *whom* is used for a filler that corresponds to the subject of the lower clause (i.e., (7)). This would be totally unexpected if the non-prescriptive type were governed by the same constraints as the prescriptive type. A separate analysis should therefore be provided on the *who/whom* distribution in this type.

The next section will deal with the informal and prescriptive types, and then in section 4 we will move on to the non-prescriptive type.

### 3 Informal and prescriptive types of register

This section shows that no additional theoretical apparatus will be needed beyond those proposed in previous work to give an account for the *who/whom* distribution in the informal and the prescriptive types of register.

#### 3.1 Informal register

As discussed in the last section, the informal register employs *who* only. We can give the following description to this lexical item (cf. Wilcock 1999: 383).

$$(10) \quad \left[ \begin{array}{l} \text{PHON } \langle \text{who} \rangle \\ \text{CASE } \textit{case} \\ \text{REGSTR } \textit{informal} \end{array} \right]$$

Following Wilcock (1999), we represent register variation in terms of the feature REGISTER (REGSTR), which is appropriate for CONTEXT. The REGSTR feature takes a value of sort *register*, which has two subtypes, *formal* and *informal*.

The underspecification of the CASE value in (10) indicates that the

informal register always employs *who* whatever case it has. Thus, the occurrence of *who* in (1) to (5) is captured by this constraint.

- (11) a. *Who/\*whom* wrote the editorial? (1a)  
 b. We feed children *who/\*whom* we think are hungry. (2a)  
 c. those *who/\*whom* we consulted. (3a)  
 d. *Who/\*whom* did you meet? (4a)  
 e. Who will marry *who/\*whom*? (5a)  
 f. To *whom/\*who* are you referring? (6a)

*Who* in (11a,b) is nominative, and that in (11c,d,e) is accusative. The constraint in (10) licenses these occurrences of *who* since its CASE value is underspecified and is compatible with both nominative and accusative. The unavailability of *whom* in the informal register can be accounted for by assuming that this register does not employ this lexical item whatsoever. The impossibility of *who* in pied-piping in (6) can be attributed to the fact that the formal status of pied-piping conflicts with the [REGSTR *informal*] specification of *who*. Wilcock (1999) has provided an argument along the same lines, which is entirely compatible with our approach. Wilcock's (1999) analysis of pied-piping will be summarised in Appendix.

### 3.2 Prescriptive type of formal register

Let us turn to the prescriptive type of formal register. As discussed earlier, *who* appears not only in an informal style but also in a formal style when it is a subject of the nearest following verb as in (1), and when it is a subject of the lower clause as in (2).

- (12) a. *Who/\*whom* wrote the editorial? (1a)  
 b. We feed children *who/\*whom* we think are hungry. (2a)

In these syntactic environments, *whom* is excluded. In all the non-subject environments, however, *whom* is employed.

- (13) a. those *whom/\*who* we consulted. (3a)  
 b. *Whom/\*who* did you meet? (4a)  
 c. Who will marry *whom/\*who*? (5a)  
 d. To *whom/\*who* are you referring? (6a)

The distribution of *who* and *whom* in this type can be formalised along the



same lines as an ordinary case assignment.<sup>3</sup> We propose that the grammar of the prescriptive type of formal register includes the following constraints.

(14) a. *who* (prescriptive type)

$$\left[ \begin{array}{l} \text{PHON } \langle \text{who} \rangle \\ \text{CASE } \textit{nom} \\ \text{REGSTR } \textit{formal} \end{array} \right]$$

b. *whom* (prescriptive type)

$$\left[ \begin{array}{l} \text{PHON } \langle \text{whom} \rangle \\ \text{CASE } \textit{acc} \\ \text{REGSTR } \textit{formal} \end{array} \right]$$

*Who* in (12a) is nominative, so it is licensed by (14a). (14b), which only licenses use of *whom* when accusative, excludes *whom* from this environment. The SLASH mechanism requires the LOC value of the filler to be the same as that of the gap, and therefore a filler associated with a gap in lower clause is assigned the case that is assigned to the position of the gap. In the case of *who* in (12b), the filler has nominative case since the SLASH mechanism ensures that it has the same LOC value and hence the same case as the gap. Thus, these two constraints and the HPSG view of unbounded dependencies capture the occurrence of *who* in the prescriptive type of formal register, in such examples as (1) and (2). *Whom* in (13) occurs in positions where accusative nominal is expected. Therefore, the lexical constraint (14b) licenses *whom* in these positions, but *who* is excluded due to (14a).

In this section, we have shown that existing, independently motivated theoretical apparatus within HPSG can capture the *who/whom* distribution in the prescriptive and informal types. In the next section, we will move on to the non-prescriptive type of formal register in which *who* and *whom* show an apparently puzzling behaviour as discussed in the earlier sections.

---

<sup>3</sup> For the HPSG literature on case, see Heinz and Matiassek (1994), Meurers (2000), Pollard (1994), Przepiórkowski (1999), etc.

## 4 The non-prescriptive type of formal register

The characteristics of the non-prescriptive type of formal register are illustrated by the following minimal pair.

- (15) a. the man *who*/\**whom* has left  
b. the man *whom*/\**who* I believe has left

It is impossible to adopt the case marking strategy proposed for the prescriptive type in the last section since the SLASH mechanism would allow the CASE value of the both types of subject to have the same range of choice.

We look at the pair in (15) from the point of view of linear order: *who* is employed for the subject of the nearest following verb and *whom* for the subject of a later verb. In this section, we will formalize this observation. Before that, however, some theoretical assumptions will be introduced in the first sub-section.

### 4.1 Linearization-based HPSG

The analysis to be presented below will be based on a version of linearization-based HPSG. In this framework, linear order is represented in a separate level of ‘order domains’, to which ordering constraints apply (see, e.g., Pollard et al. 1993; Reape 1994; and Kathol 2000). Order domains are given as the value of the attribute DOM(AIN). At each level of syntactic combination, the order domain of the mother category is computed from the order domains of the daughter constituents. We assume, along with Reape (1994), Donohue and Sag (1999), Kathol (2000: 101), and Jaeger (2003), that an order domain consists of an ordered list of signs, which we will call ‘DOM elements’.<sup>4</sup> The domain elements of a daughter may be compacted to form a single element in the order domain of the mother or they may just become elements in the mother’s order domain. In the latter case the mother has more domain elements than daughters.

Each element of a clausal order domain is uniquely marked for the region that it belongs to (Kathol 2000; see also Borsley and Kathol 2000; Chung and Kim 2003; Kathol 2002; and Penn 1999).<sup>5</sup> The assignment of

---

<sup>4</sup> The assumption that DOM elements are signs might involve some problems. See Kathol (2000) for discussion.

<sup>5</sup> In the case of German, this partitioning of the clausal domain directly encodes the

each element in a clause can be summarised as follows (Kathol 2002).

(16)

	<i>first</i>	<i>second</i>	<i>third</i>	<i>fourth</i>	<i>fifth</i>
a.	Who	did	Sandy	see?	
b.	Never	would	Kim	eat	those cookies
c.		Will	Kim	sneeze?	
d.			Kim	will eat	those cookies
e.			Who	ate	those cookies

*Wh*-phrases which are not the subject of the verb in *fourth* are assigned to *first*. Thus, the clause-initial element in verb-second clauses, such as the *wh*-phrase in (16a) and the negative phrase in (16b), are in *first*. In these clause types, finite verbs are assigned to *second*. Finite verbs in verb-first clauses such as polar questions (16c) are also in *second*. Verbs which are not in *second* are in *fourth*, whether they are finite or non-finite. Complements of the verb in *fourth* are in *fifth*. Finally, subjects of the verb in *fourth* are in *third*, whether they are a filler or an ordinary subject. If we do not treat a subject *wh*-phrase as a case of extraction (Pollard and Sag 1994; see also Gazdar 1981), this positional assignment will easily be incorporated into the Head-Subject Schema. Evidence has recently been put forth, however, that a subject *wh*-phrase is an instance of true extraction (Bouma et al. 2001; Ginzburg and Sag 2000; Levine and Hukari 2003). Therefore, we assume the following additional constraint on head-filler structures: if the LOC value of the filler is token-identical with that of the single element in the SUBJ list of the verb in *fourth*, then it is assigned to *third*.

In this framework, *Who wrote the editorial?* has the representation in (17) at the next page.<sup>6</sup> The NP *the editorial* has two daughters, and two DOM elements, *the* and *editorial*. The VP *wrote the editorial* has two daughters and its order domain contains two DOM elements, one for *wrote* and one for *the editorial* which has been compacted to a single element. The top S node has two daughters but its order domain contains three DOM

---

traditional German grammar notion of ‘topological fields’. See Kathol (2000) for details.

<sup>6</sup> The combinatorial structure represented here is based on Ginzburg and Sag (2000: 236ff), but it is simplified.

elements, which are for *who*, *wrote* and *the editorial*, respectively. According to the assumptions for position assignment outlined above, *who* is assigned to *third*, *wrote* to *fourth*, and *the editorial* to *fifth*.

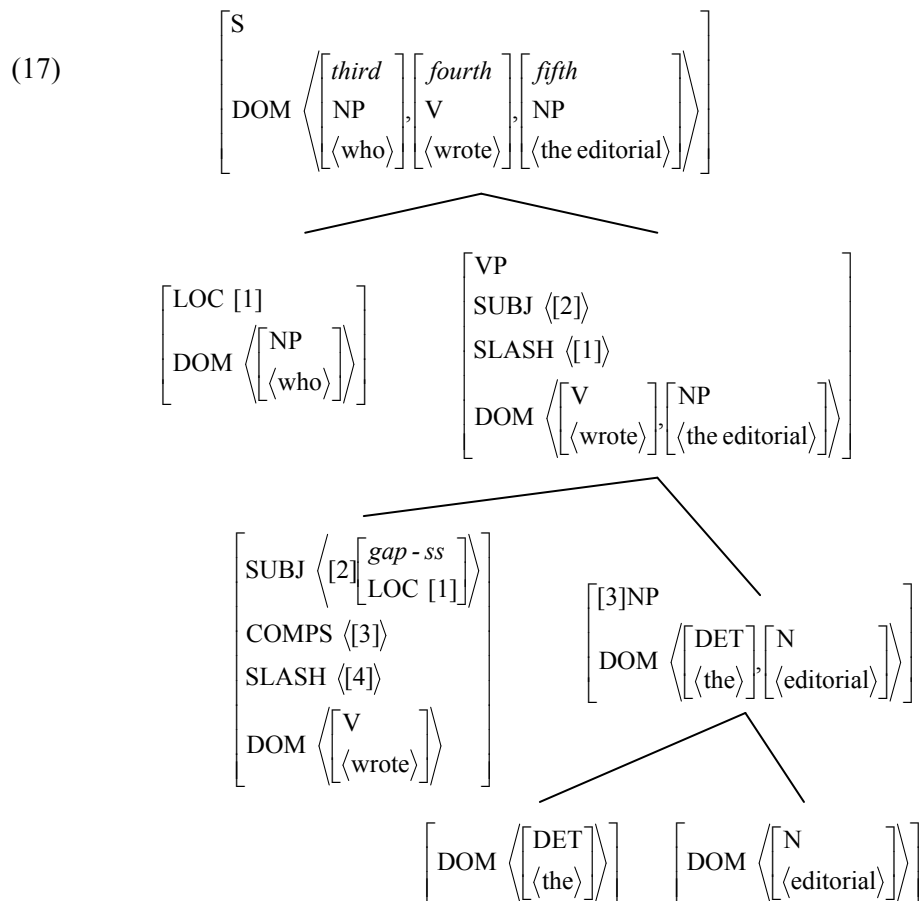

#### 4.2 A linearization-based HPSG account

We are now in a position to account for the *who/whom* distribution in the non-prescriptive type of register. We assume that the grammar of this register type include the following lexical constraints for *who* and *whom*, instead of (14a,b) for the prescriptive type.

(18) a. *who* (non-prescriptive type)

$$\left[ \begin{array}{l} \text{REGSTR } \textit{formal} \\ \text{DOM } \left\langle \left[ \begin{array}{l} \textit{third} \\ \text{PHON } \langle \textit{who} \rangle \end{array} \right] \right\rangle \end{array} \right]$$

b. *whom* (non-prescriptive type)

$$\left[ \begin{array}{l} \text{REGSTR } \textit{formal} \\ \text{DOM } \left\langle \left[ \begin{array}{l} \neg \textit{third} \\ \text{PHON } \langle \textit{whom} \rangle \end{array} \right] \right\rangle \end{array} \right]$$

The lexical description (18a) allows *who* to occur only in *third*. Due to the lexical description (18b) for *whom*, it is allowed to occur anywhere else.

The DOM value of the top S node of (15a) looks as follows (Recall the combinatorial structure of (1a) given in (17)).<sup>7</sup>

$$(19) \quad \left[ \text{DOM } \left\langle \left[ \begin{array}{l} \textit{third} \\ \text{NP} \\ \text{PHON } \langle \textit{who} \rangle \\ \text{LOC } [1] \\ \text{REGSTR } \textit{formal} \end{array} \right] , \left[ \begin{array}{l} \textit{fourth} \\ \text{V} \\ \text{PHON } \langle \textit{wrote} \rangle \\ \text{SUBJ } \left\langle \left[ \begin{array}{l} \textit{gap-ss} \\ \text{LOC } [1] \end{array} \right] \right\rangle \end{array} \right] , \dots \right\rangle \right]$$

In the order domain, *who* occurs in *third* as its LOC value is token-identical to that of the single element of the SUBJ list of the verb. The representation in (20) is not well-formed since *whom* occurs in *third*, which violates the constraint (18b).

$$(20) \quad * \left[ \text{DOM } \left\langle \left[ \begin{array}{l} \textit{third} \\ \text{NP} \\ \text{PHON } \langle \textit{whom} \rangle \\ \text{LOC } [1] \\ \text{REGSTR } \textit{formal} \end{array} \right] , \left[ \begin{array}{l} \textit{fourth} \\ \text{V} \\ \text{PHON } \langle \textit{wrote} \rangle \\ \text{SUBJ } \left\langle \left[ \begin{array}{l} \textit{gap-ss} \\ \text{LOC } [1] \end{array} \right] \right\rangle \end{array} \right] , \dots \right\rangle \right]$$

The nominative *whom* in (15b) can be accounted for in the following

<sup>7</sup> Only the relevant information is shown here.

way. The top S node of (15b) has the DOM list of the following sort.<sup>8</sup>

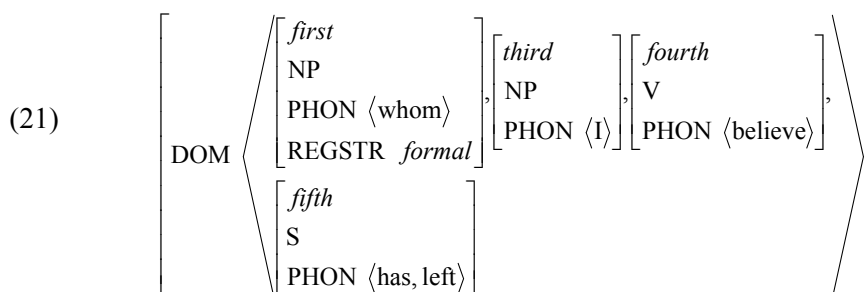

As stated earlier, we assume that a *wh*-phrase which is not the subject of the verb in *fourth* is assigned to *first*. In (21) *whom* is not the subject of *believe*, and therefore it occurs in *first*. This is compatible with constraint (18b) that specifies its occurrence in this position. Due to (18a), however, *who* is not allowed in this position in the non-prescriptive type since the occurrence of *who* is restricted just to *third*.

Constraint (18b) can capture the occurrence of *whom* in (3) to (6). Let us look at each case.

- (22) a. those *whom*/\**who* we consulted. (3a)  
 b. *Whom*/\**who* did you meet? (4a)  
 c. Who will marry *whom*/\**who*? (5a)  
 d. To *whom*/\**who* are you referring? (6a)

Positional assignment of the elements in each of these sentences is as follows.

(23)

	<i>first</i>	<i>second</i>	<i>third</i>	<i>fourth</i>	<i>fifth</i>
(22a)	<b>whom</b>		we	consulted	
(22b)	<b>Whom</b>	did	you	meet	
(22c)			Who	will	marry <b>whom</b>
(22d)	To <b>whom</b>	are	you	referring	

<sup>8</sup> It is assumed that an embedded clause is totally-compacted when it is combined with a higher clause. Thus, the clause *has left* is a single compacted DOM element in (21). See Ginzburg and Sag (2000: 180ff) for details of the constituent structure of this sort of construction.

(23) shows that *whom* in (22a,b) is in *first*, and *whom* in (22c,d) is included in a domain element in *fifth*.<sup>9</sup> Thus, every occurrence of *whom* in (22) conforms to (18b) which determines its occurrence in positions which are not *third*. On the other hand, use of *who* in these environments are excluded by (18a), which restricts its occurrence to *third*.

The following examples where there is an adverb intervening between *who* and the verb can also be accounted for by our analysis.

- (24) a. a man who/\*whom *never* sleeps  
 b. Who/\*whom *often* saw John?

The order domain of the relative clause in (24a) has the following representation.

(25)

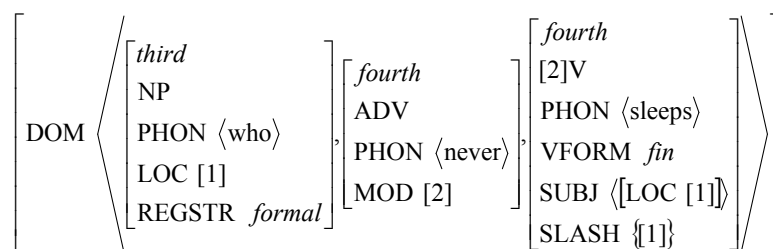

We follow Kathol (2002) in assuming that preverbal adverbials as in (24) are assigned to *fourth*, along with the verbs. In (25), although there is an intervening adverb *never*, *sleeps* is in *fourth*, and *who* is its subject (i.e., its LOC value [1] is token-identical with the LOC value of the single element in the SUBJ list of *sleeps*). *Who* is therefore assigned to *third*, and that is licensed by constraint (18a); *whom* is banned because of its positional specification as  $[-\textit{third}]$  in (18b).

We assumed earlier that verbs which are not in *second* are in *fourth*. This means that verbs in *third* can be not only finite, as all the examples so far, but also non-finite (i.e., *infinitive*, *base*, *participle*; see Ginzburg and Sag 2000: 24). We further assumed that the element positioned in *third* is a

<sup>9</sup> We assume *wh*-phrases to occur in *first* in embedded clauses in English, unlike German (Kathol 2000, 2001). In the embedded clause of (i), *second* is occupied by *would*, and hence it is natural to assume that *what* (as well as *under no circumstances*) is in *first*.

(i) I wonder [what under no circumstances would John do for Mary].

subject of the verb in *fourth*. It is predicted, therefore, that *who* can be a subject of the non-finite verb in *third*. This is borne out by the following example.

- (26) A: What did Kim do?  
 B: What did *who* do?

The utterance B is an example of an echo question.<sup>10</sup> In this sentence *who* is followed by an non-finite verb *do*. The DOM list of the lower S (i.e., [did who do]) would look like the following.

(27)

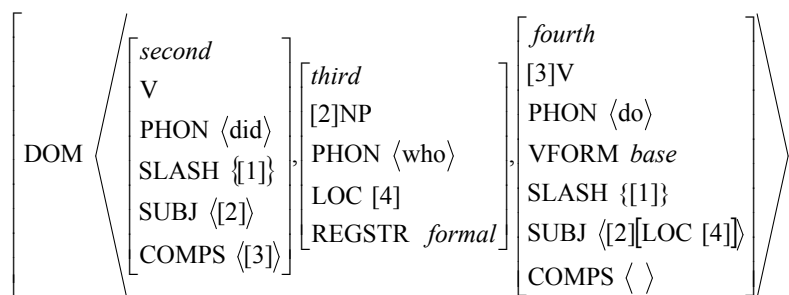

As we assumed earlier, finite verbs in verb-second clauses such as *wh*-questions are in *second*. The non-finite verb *do* is in *fourth*, and *who* is its subject (i.e., its LOC value [4] is token-identical with the LOC value of the single element in the SUBJ list of *sleeps*). *Who* is therefore in *third*, and that is licensed by (18a); *whom* is excluded since (18b) states that its positional specification is [ $-\textit{third}$ ].

### 4.3 Summary

In this section, we have provided an account for the seemingly puzzling distribution of *who/whom* in the non-prescriptive type. The lexical descriptions of *who* (18a) and *whom* (18b) incorporate the specification of the position where they should occur: *who* is restricted to *third* while *whom* is specified to occur in the positions other than *third*. What is significant is that we abandoned the idea that the *who/whom* distinction is a matter of case marking, and that makes it possible to accommodate the occurrence of *whom*

<sup>10</sup> See Ginzburg and Sag (2000: 255ff) for details of an HPSG treatment of echo questions.



in the cases where nominative case is normally expected, as in (15b).

## 5 Lasnik and Sobin's (2000) approach

In this section we consider the ability of another approach to capture the relevant facts. A recent attempt to provide a theoretical account of the *who/whom* distinction is Lasnik and Sobin's (2000).<sup>11</sup> They argue that *who* is the basic form of the *wh*-pronoun, which can check either nominative (NOM) or accusative (ACC) case. The suffix *-m* of *whom* is assumed to be associated with an additional ACC feature and has to be checked independently of the ACC feature associated with the stem *who*. This additional ACC feature carried by the suffix is checked by the rules with the status of 'grammatical viruses', characterised as extra-grammatical devices, entirely independent of ordinary case marking mechanisms. They serve to license prestige forms. Rule (28) licenses the occurrence of *whom* as object of a verb or preposition, as in (5) and (6).

(28) The Basic 'whom' Rule (Lasnik and Sobin 2000: 354)

If:  $[\text{V/P}]$     *who-*    *-m*  
                                  [ACC]    [ACC]  
                                  1        2        3  
then: check ACC on 3

Rule (29) licenses the occurrence of initial *whom* in any type of *wh*-construction where the *wh*-pronoun functions as the object of a verb (3a, c) and (4a), stranded preposition (3b) and (4b), or the subject of an embedded clause (7).

(29) The Extended 'whom' Rule (Lasnik and Sobin 2000: 359)

If: *who-*    *-m*    ...    *NP*,    where  
                                  [ACC]  
                                  1        2                    3  
a) 3 is the nearest subject NP to 2, and  
b) '...' does not contain a V which has 1–2 (a single word *whom*) as its subject,

---

<sup>11</sup> See also Kayne (1984) and Radford (1988).

then: check ACC on 2.

The unacceptable occurrences of *whom* in (1) are ruled out by the fact that they are not compatible with the sequential arrangement of (28) or (29).

However, their approach involves some problems. First, it is not clear whether the *who/whom* distinction should be treated as a matter of case. Two different forms of a lexeme should not necessarily be seen as two different case forms. If they are not realisations of case, it will not be necessary to assume that the stem *who-* and the affix *-m* have two different cases. Other things being equal, it would be preferable not to have such a counter-intuitive assumption.

Second, as Lasnik and Sobin (2000: 362) themselves note, (29) is fairly complex; especially it includes the stipulations about 3 and about what can appear between 2 and 3. A rule that is acquired in a special way may be complex than an ordinary grammatical rule, and, as they suggest (2000: 362), such complexity may be a reason for being a prestige usage. Complexity, however, is a potential source of suspicion, and it is indeed suspicious in this case since the stipulations included are questionable. First, it is not obvious how ‘the nearest subject NP to 2’ is to be identified within Principles and Parameters assumptions. Next, their analysis includes the stipulation about what can appear between 2 and 3: the V should be a theta-role assigner and must not be an auxiliary verb. It is not clear why a theta-role assigning ability is relevant here. Our HPSG analysis is clearly simpler which is free of any questionable stipulations.

## 6 Concluding remarks

In this paper, we have been concerned with the distribution of the English interrogative/relative pronouns *who* and *whom*. We have first described the distribution of *who* and *whom*, which appears to be complex. In section 2, we showed that the apparent complexity of the data is restricted to just non-prescriptive type if we distinguish three separate register types: informal type, prescriptive type, and non-prescriptive type. Section 3 illustrated that the general framework of HPSG can accommodate the *who/whom* distinction in the informal and prescriptive types without any additional theoretical apparatus beyond those proposed in previous work. In section 4 we showed that a linearization-based constraint can provide a straightforward account for

the quite puzzling distribution which *who* and *whom* show in the non-prescriptive type. Section 5 discussed Lasnik and Sobin's (2000) analysis within Virus Theory and it was compared with our HPSG analysis.

The most important point to note is that the constraints in (18), which are responsible for the use of *who* and *whom* in the non-prescriptive type of formal register, is formalised in terms of order domains. If our analysis is on the right track, it suggests that order domains are important not only for analysing linearization phenomena but also for the analysis of certain word forms. This matches the recent development of linearization-based HPSG, in which order domains have been concerned with more than just linearization.

### Appendix: Wilcock's (1999) analysis of *whom* in pied-piping

The impossibility of *who* in pied-piping in (6) is due to the fact that the formal status of pied-piping conflicts with the [REGSTR *informal*] specification of *who*, along the lines of Wilcock (1999; cf. Paolillo 2000).

- (6) a. To *whom*/\**who* are you referring?  
 b. someone on *whom*/\**who* we can rely

This appendix will summarise Wilcock's (1999: 384ff) approach to this issue.

Wilcock (1999) notes systematic covariation between register and nonlocal features of preposition. This is formalised as lexical constraints in which register restrictions are associated with PP construction subtypes.

- (30) a.  $rel - prep \rightarrow \left[ \begin{array}{l} HEAD \textit{ prep} \\ QUE \{ \} \\ REL \{ \{1\} \} \\ SLASH \{ \} \\ REGSTR \textit{ formal} \end{array} \right]$
- b.  $que - prep \rightarrow \left[ \begin{array}{l} HEAD \textit{ prep} \\ QUE \{ \{1\} \} \\ REL \{ \} \\ SLASH \{ \} \\ REGSTR \textit{ formal} \end{array} \right]$

(30) requires prepositions with non-empty REL (30a) and non-empty QUE

(30b) to have the formal register. The combination of these lexical constraints with the Register Amalgamation Constraint (31) provides an account for the distribution of *who/whom* in (6).

(31) Register Amalgamation Constraint (Wilcock 1999: 382)

$$word \rightarrow \left[ \begin{array}{l} \text{ARG-ST} \langle [\text{REGSTR } [1]], \dots, [\text{REGSTR } [1]] \rangle \\ \text{REGSTR } [1] \end{array} \right]$$

(31) is a lexical constraint that ensures the amalgamation of contextual information from a word's arguments.

(32) is the constituent structure for the filler PP of (6a).

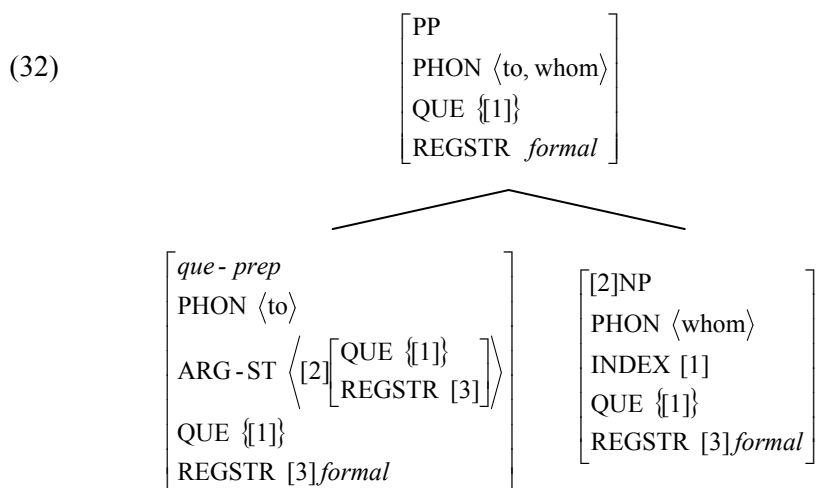

The SLASH Amalgamation Constraint requires that the non-empty QUE of *whom* should be amalgamated into the QUE value of *with*. The preposition has thereby a non-empty QUE, so constraint (30b) requires it to have the formal register. The Register Amalgamation Constraint (31) requires the REGSTR value of the argument to be unified with that of the head. This requirement is indeed satisfied here since *whom* is lexically specified as [REGSTR *formal*] by (14b).<sup>12</sup>

Let us turn to ungrammaticality of *who* in (6). The representation of

<sup>12</sup> In order to ensure that a phrase inherits the REGSTR values of its daughters, Wilcock (1999: 377) introduces the Contextual Head Inheritance Principle, which states that in a *head-nexus-phrase* and a *head-adjunct-phrase* the phrase's CONTEXT is by default token-identical to that of its contextual head daughter.

the head of the filler PP in (6a) is something like the following.

$$(33) \quad * \left[ \begin{array}{l} que - prep \\ PHON \langle to \rangle \\ ARG-ST \left\langle [2] \left[ \begin{array}{l} QUE \{[1]\} \\ REGSTR informal \end{array} \right] \right\rangle \\ QUE \{[1]\} \\ REGSTR [3] formal \end{array} \right]$$

The SLASH Amalgamation Constraint requires the non-empty QUE of *who* to be amalgamated into the QUE value of *to*, which is tagged [1] in (33). The preposition has thereby a non-empty QUE, so constraint (30b) requires it to have the formal register. However, the REGSTR value of *who* cannot be unified with that of *with*: *informal* and *formal*, respectively. This is a violation of the Register Amalgamation Constraint (31).

## References

- Borsley, R. D. 2005. On the superficiality of Welsh agreement and related matters. Unpublished paper. University of Essex.  
(<http://privatewww.essex.ac.uk/~rborsley/superficial-agreement-paper.pdf>).
- Gazdar, G. 1981. Unbounded dependencies and coordinate structure. *Linguistic Inquiry* 12, 155–184.
- Ginzburg, J. and Sag, I. A. 2000. *Interrogative Investigations*. Stanford: CSLI Publications.
- Heinz, W. and Matiasek, J. 1994. Argument structure and case assignment in German. In Nerbonne, J., et al (eds.), 199–236.
- Huddleston, R. and Pullum, G. K. 2002. *The Cambridge Grammar of the English Language*. Cambridge: Cambridge University Press.
- Jaeger, T. F. 2003. Topics First! In- and outside of Bulgarian *wh*-interrogatives. In Müller, S., (ed.), *Proceedings of the 10th International Conference on Head-Driven Phrase Structure Grammar*. Stanford: CSLI Publications. 181–202.
- Jespersen, O. 1924. *The Philosophy of Grammar*. Chicago: University of Chicago Press.
- Jespersen, O. 1927. *A Modern English Grammar on Historical Principles, Part III*. London: Allen & Unwin.
- Kathol, K. 2000. *Linear Syntax*. Oxford: Oxford University Press.
- Kayne, R. S. 1984. *Connectedness and Binary Branching*. Dordrecht: Foris Publications.
- Lasnik, H. and Sobin, N. 2000. The *who/whom* puzzle: on the preservation of an archaic feature. *Natural Language and Linguistic Theory* 18, 343–371.

- Levine, R. and Hukari, T. 2003. *The Unity of Unbounded Dependency Constructions*. Unpublished manuscript.
- Maekawa, T. 2004. Constituency, word order and focus projection. In Müller, S. (ed.), *Proceedings of the 11th International Conference on Head-Driven Phrase Structure Grammar*. Stanford: CSLI Publications. 168–188.
- Meurers, W. D. 2000. Raising spirits (and assigning them case). *Groninger Arbeiten zur Germanistischen Linguistik* 43, 173–226.
- Nerbonne, J., Netter, K. and Pollard, C. (eds.). 1994. *German in Head-Driven Phrase Structure Grammar*. Stanford: CSLI Publications.
- Paolillo, J. 2000. Formalizing formality: an analysis of register variation in Sinhala. *Journal of Linguistics* 36, 215–259.
- Penn, G. 1999. Linearization and *WH*-extraction in HPSG: Evidence from Serbo-Croatian. In Borsley R. D. and Przepiórkowski A. (eds.), *Slavic in Head-Driven Phrase Structure Grammar*. Stanford: CSLI Publications. 149–182.
- Pollard, C. 1994. Toward a unified account of passive in German. In Nerbonne, J., et al (eds.), 273–296.
- Pollard, C., Kasper, R. and Levine, R. 1994. Studies in constituent ordering: Towards a theory of linearization in Head-Driven Phrase Structure Grammar. Research Proposal to the National Science Foundation, Ohio State University.
- Przepiórkowski, A. 1999. On case assignment and ‘adjuncts as complements’. In Webelhuth, G., et al (eds.), 231–245.
- Quirk, R., Greenbaum, S., Leech, G. and Svartvik, J. 1985. *A Comprehensive Grammar of the English Language*. London: Longman.
- Radford, A. 1988. *Transformational grammar*. Cambridge: Cambridge University Press.
- Reape, M. 1994. Domain union and word order variation in German. In Nerbonne, J., et al (eds.), 151–98.
- Swan, M. 1995. *Practical English Usage*. Oxford: Oxford University Press.
- Wilcock, G. 1999. ‘Lexicalization of context’. In Webelhuth, G., et al (eds.), 373–387.
- Webelhuth, G., Koenig, J-P. and Kathol, A. (eds.). 1999. *Lexical and Constructional Aspects of Linguistic Explanation*. Stanford: CSLI Publications.
- Yatabe, S. 2001. The syntax and semantics of left-node raising in Japanese. In Flickinger D. and Kathol A. (eds.), *Proceedings of the 7th International Conference on Head-Driven Phrase Structure Grammar*. Stanford: CSLI Publications. 325–344.
- Yoshimoto, K. 2000. A bistratal approach to the prosody-syntax interface in Japanese. In Cann, R., Grover, C. and Miller, P. (eds.), *Grammatical Interfaces in Head-Driven Phrase Structure Grammar*. Stanford: CSLI Publications. 267–282.
- Yoshimoto, K. 2003. A linear approach to multiple clause embedding. In Kim, J.-B. and Wechsler, S. (eds.), *The Proceedings of the 9th International Conference on Head-Driven Phrase Structure Grammar*. Stanford: CSLI Publications. 439–458.

# From “hand-written” to computationally implemented HPSG theories

Nurit Melnik 

Haifa University

Proceedings of the 12th International Conference on  
Head-Driven Phrase Structure Grammar

Department of Informatics, University of Lisbon

Stefan Müller (Editor)

2005

Stanford, CA: CSLI Publications

pages 311–321

Melnik, Nurit. 2005. From “hand-written” to computationally implemented HPSG theories. In Stefan Müller (ed.), *Proceedings of the 12th International Conference on Head-Driven Phrase Structure Grammar, Department of Informatics, University of Lisbon*, 311–321. Stanford, CA: CSLI Publications. DOI: 10.21248/hpsg.2005.17.



## Abstract

The process of turning a “hand-written” HPSG theory into a working computational grammar requires complex considerations. Two leading platforms are available for implementing HPSG grammars: The LKB and TRALE. These platforms are based on different approaches, distinct in their underlying logics and implementation details. This paper adopts the perspective of a computational linguist whose goal is to implement an HPSG theory. It focuses on ten different dimensions, relevant to HPSG grammar implementation, and examines, compares, and evaluates the different means which the two approaches provide for implementing them. The paper concludes that the approaches occupy opposite positions on two axes: FAITHFULNESS to the “hand-written” theory and COMPUTATIONAL ACCESSIBILITY. The choice between them depends largely on the grammar writer’s preferences regarding those properties.

## 1 Overview

HPSG has logical and mathematical foundations which make it amenable to computational implementation. Yet it is seldom the case that this potential is in fact fulfilled, although there exist a number of platforms for implementing HPSG grammars. Thus, most descriptions and analyses of linguistic phenomena in the literature are not substantiated by a working computational grammar.

Two leading implementation platforms are available for implementing HPSG grammars. The Linguistic Knowledge Building (LKB) system (Copestake, 2002) is the primary engineering environment of the LinGo English Resource Grammar (ERG) at Stanford. The LKB is developed not particularly for implementing HPSG grammars, but rather, as a framework independent environment for typed feature structures grammar. TRALE, an extension of the Attribute Logic Engine (ALE) system, is a grammar implementation platform that was developed as part of the MiLCA project (Meurers et al., 2002), specifically for the implementation of theoretical HPSG grammars that were not explicitly written for language processing.<sup>1</sup> The two platforms are based on different approaches, distinct in their underlying logics and implementation details.

This paper adopts the perspective of a computational linguist whose goal is to implement an HPSG theory. It is based on the implementation of a “hand-written” grammar proposed by Melnik (2002) to account for verb initial constructions in Modern Hebrew. A representative subset of the grammar, including word order, agreement, and valence alternation phenomena, serves as a test case.

---

<sup>†</sup>This is a slightly revised version of the abstract that was submitted to the HPSG-2005 conference. The full paper is downloadable from <http://cl.haifa.ac.il/projects/hebgrammar>. This research was supported by the Israel Science Foundation (grant no. 136/01) and by The Caesarea Edmond Benjamin de Rothschild Foundation Institute for Interdisciplinary Applications of Computer Science. Many thanks to Shuly Wintner for his support and valuable comments and to anonymous reviewers for HPSG-2005 for their constructive comments.

<sup>1</sup>See <http://milca.sfs.nphil.uni-tuebingen.de/A4/HomePage/English/beschr.html>



The paper focuses on different dimensions, relevant to HPSG grammar implementation: type definition, grammar principles, lexical rules, exhaustive typing, definite relations, non-binary grammar rules, semantic representation, grammar evaluation, and user-interface. It examines, compares, and evaluates the different means which the two approaches provide for implementation, by referring to examples from a “hand-written” grammar fragment that was implemented in the two systems. The paper concludes that the approaches occupy diametrically opposed positions on two axes: FAITHFULNESS to the “hand-written” theory and COMPUTATIONAL ACCESSIBILITY. The findings of this paper are valuable to linguists who are interested in implementing their grammar, as well as to those who develop implementation platforms.

## 2 Type Definition

Types in a typed feature-structure framework are defined by determining (i) the type’s hierarchical relation to other types, (ii) appropriateness conditions, (iii) constraints on the values of embedded features, and (iv) path equations.

TRALE separates the SIGNATURE, where the first two properties are defined, from the THEORY, in which the latter are stated. In the signature file, types are entered in a list format, where subtypes appear indented under their respective supertype(s). Features and values are introduced following the type. Constraints on embedded features and path equations are entered separately from the signature in the theory file as implicational constraints in which the type is the antecedent.

The LKB, on the other hand, takes a centralized bottom-up approach, where all the information related to a type is defined in one location, in the TYPES file. The definition of each type, then, includes a list of its immediate supertype(s) and introduced features, as well as all other type-related constraints. This approach facilitates the task of defining the type inventory and accessing this information while developing the grammar.

Although the hierarchies are defined differently in the two systems, they are both subject to the glb condition, which requires that the hierarchy be a bounded complete partial order (BCPO). Thus, when a non-BCPO hierarchy is defined, TRALE enforces the condition by producing an error message during compilation. The LKB, on the other hand, automatically creates a glb type in each case of violation and restructures the hierarchy accordingly.

On the one hand, by automatically fixing the violation, the LKB enables the grammar writer to maintain ignorance regarding a potentially confusing issue. This ignorance, however, turns into confusion once the grammar writer views the type hierarchy diagram. The automatic restructuring of the hierarchy, including the addition of generically named types, may be incomprehensible to the naive grammar writer. Moreover, the resulting hierarchy is reflected only in the display and not in the actual definitions, rendering the automatically created glb types, along with their generic names, inaccessible. A possible solution is to modify the hierarchy

definition to reflect the corrected hierarchy, thus allowing the grammar writer to give the glb types more meaningful labels.

Multi-dimensional type hierarchies are widely used in the HPSG literature, yet multi-dimensionality is not a part of the formal type system itself (Penn and Hoetmer, 2003). Neither the LKB nor TRALE provide the grammar writer with a way to define partitions (or dimensions) in the hierarchy. Consequently, if partition labels are implemented as types in the hierarchy, they are not distinguished formally from other types, nor do the LKB and TRALE prevent the grammar writer from defining types that inherit from two subtypes under one pseudo-partition. Moreover, a multi-dimensional inheritance hierarchy in which partitions are defined as types does not respect the glb condition, and is therefore subjected to the systems' distinct treatments, described above. Although this omission does not prevent grammar writers from implementing their grammars, the result clearly does not reflect the source and the intention of the grammar writer.

### 3 Principles

Principles in HPSG are often defined as implicational constraints. Thus, for example, the Head Feature Principle (HFP), which states that the value of the HEAD feature of the headed-phrase is structure-shared with that of its head-daughter, is defined as a type constraint on the *hd-ph* type.

$$hd-ph \rightarrow \left[ \begin{array}{l} \text{HEAD } \boxed{\perp} \\ \text{HD-DTR } \left[ \text{HEAD } \boxed{\perp} \right] \end{array} \right]$$

In the LKB principles are necessarily linked to types and are stated as part of the type definition. Thus, the HFP is implemented as part of the definition of the type *hd-ph*. In TRALE, on the other hand, principles such as the HFP are stated as part of the theory, in the form of implicational constraints where the type is the antecedent, similarly to the definition above. TRALE, however, extends implicational constraints to express principles which do not target a particular type. More specifically, the antecedent of implicational constraints can be arbitrary function-free, inequation-free feature structures .

Consider, for example, the following complex-antecedent principle (Meurers, 2001).

$$\left[ \begin{array}{l} \text{word} \\ \text{SYNSEM} | \text{LOC} | \text{CAT} \left[ \begin{array}{l} \text{HEAD} \left[ \begin{array}{l} \text{verb} \\ \text{VFORM } \textit{finite} \end{array} \right] \\ \text{VAL} | \text{SUBJ} \langle \text{LOC} | \text{CAT} | \text{HEAD } \textit{noun} \rangle \end{array} \right] \end{array} \right] \right] \\ \rightarrow \left[ \text{SYNSEM} | \text{LOC} | \dots | \text{SUBJ} \langle \left[ \text{LOC} | \text{CAT} | \text{HEAD} | \text{CASE } \textit{nominative} \right] \rangle \right]$$

The principle expresses the generalization that NP subjects of finite verbs are as-

signed nominative case. The complex antecedent singles out the relevant class of verbs without requiring there to be a corresponding type.

The ability to use implicational constraints with complex antecedents provides the grammar writer with additional means to express generalizations. When the given dimensions in the type hierarchy do not group together a particular set of objects to which a certain generalization applies, the grammar writer can choose not to expand the hierarchy, but rather to use a complex feature structure as an antecedent to an implicational constraint expressing the generalization. This solution can cut down on the size of the type hierarchy and its complexity.

## 4 Lexical Rules

The main issue that is pertinent to the implementation of lexical rules (LRs) is the “carrying over” of information from the input to the output of the rule. The descriptions of the input and output of lexical rules generally include only the features and values that are relevant for the particular rule; either those which constrain the types of objects on which to apply the rule or those which provide “information handles” (Meurers, 1994). All information which is not changed by the lexical rule is assumed to be copied over from the input to the output. An implementation platform thus has to implement the explicit as well as implicit copying of values.

The LKB views lexical rules as unary grammar rules which relate a mother structure (the output) to its daughter (the input). Similarly to grammar rules, the description of the daughter is included in the `ARGS` feature of the mother. This provides a partial solution to the “carrying over” problem — the descriptions of both the mother and daughter are a part of a single feature structure. Nevertheless, the grammar writer is required to explicitly specify by structure-sharing the information that is copied over. Aside from deviating from HPSG conventions, this solution may result in a loss of generality.

TRALE provides two mechanisms for implementing lexical rules: the traditional ALE mechanism and a mechanism referred to as ‘description-level lexical rules’ (DLRs) which encodes the treatment proposed in Meurers and Minnen (1997). Unlike the format of the rules in the LKB, the TRALE syntax for both types of LRs is similar to the familiar ‘ $X \Rightarrow Y$ ’ notation. More importantly, from the perspective of the grammar writer, the main distinction between the two approaches is in the “carrying over” mechanism. ALE LRs, similarly to the LKB mechanism, require explicit specification of “carried over” information. The DLR version provides an automatic “carrying over” mechanism which implements the intuitions behind the “hand-written” version of lexical rules. This is a clear advantage in terms of approximating written theories and maintaining generality.

## 5 Exhaustive Typing and Subtype Covering

‘Exhaustive typing’ refers to a particular interpretation of the signature according to which subtypes exhaustively cover their supertypes. Consequently, if an object is of a certain non-maximal type  $t$  then it is also of some more specific subtype subsumed by  $t$ .<sup>2</sup>

A simple example is the HPSG analysis of subject-auxiliary inversion in English. In order to restrict the licensing of inversion to auxiliary verbs, verbs are defined as having two features: INV and AUX. Furthermore, the general type *verb* is assumed to have two subtypes: *main-verb* and *aux-verb*.

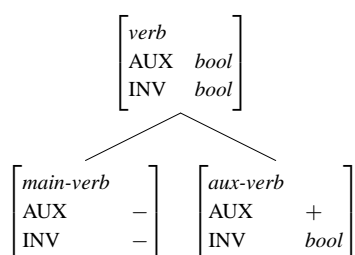

Under an exhaustive typing interpretation, objects of type *verb* which are not compatible with either *main-verb* or *aux-verb* (e.g., verbs specified with  $\left[ \text{AUX } - \right]$  and  $\left[ \text{INV } + \right]$ ) are rejected. This is the interpretation which TRALE employs. In the LKB such feature structures are accepted.

In addition, TRALE employs a subtype covering strategy whereby if the system recognizes that the values of a feature structure of a non-maximal type are consistent with the values of only one of its subtypes, it will promote those values to the values of the compatible subtype. This is justified only under an exhaustive typing interpretation, and is therefore not a part of the LKB system.

One advantage to TRALE’s approach is that it implements an implicit assumption in “standard” HPSG (e.g., Pollard and Sag (1994)) and is thus appropriate if the goal is to narrow the gap between “hand-written” theories and their implemented counterparts. Second, Meurers (1994) notes that “while both interpretations allow the inference that appropriateness information present on a type gets inherited to its subtypes, we can now additionally infer the appropriateness specifications on a type from the information present on its subtypes”. Moreover, in addition to increasing the expressive power, such a system facilitates syntactic detection of errors and increased efficiency in processing (Meurers, 1994).

The main reasons that are given for adopting the alternative approach, often referred to as ‘open-world reasoning’, are not theoretical, but rather, motivated by engineering considerations. This type of reasoning allows the grammar writer

<sup>2</sup>This interpretation is also referred to in the literature as ‘closed world’. However, as one reviewer pointed out, the terms ‘closed/open world’ have a different meaning in the study of programming languages and should therefore be avoided.

to be non-committal regarding the complete inventory of types needed to account for the language. This is particularly helpful during incremental grammar/lexicon development.

## 6 Definite Relations

“Hand-written” HPSG makes use of various relations which are external to the description language, many of which apply to lists and sets. One such relation is `APPEND`. The LKB and TRALE differ greatly in the solutions that they offer for implementing “hand-written” analyses which make use of definite relations. The LKB takes a conservative stance and adheres to the description language, while TRALE augments the description language with a programming language for implementing definite relations and incorporating them into type constraints and rules.

Programming definite relations in the TRALE environment is very similar to programming in Prolog, with the exception that first-order terms in Prolog are replaced with descriptions of feature structures. Thus, a list in this case is not a list of terms, but rather a list of descriptions of feature structures.

A thorough discussion of the benefits of adding recursive relations to the description language of implementation platforms for HPSG grammars is found in Meurers et al. (2003), which compares the treatment of unbounded dependencies and optional arguments in the ERG, implemented in the LKB, with that of TRALE. They conclude that the ability to express relational goals increases the grammar’s modularity and its ability to express generalizations, and reduces the gap between “hand-written” theories and their implemented counterparts. This conclusion is echoed in the following section.

## 7 Non-binary Grammar Rules

Grammar rules in the HPSG literature are not restricted to binary rules. A prime example is the head-complement phrase, one of the most basic phrase structures in the grammar. In addition to being non-binary, the head-complement phrase rule is designed to account for phrases with a varying number of daughters. Implementing a rule for such a phrase type poses a number of challenges for a computational system, challenges which are handled differently by the two systems.

The assumption in the LKB is that the number of daughters associated with each rule is fixed. Thus, for grammars which are not restricted to binary branching trees the grammar writer needs to define phrase types and grammar rules for each arity. TRALE provides a special `cats>` operator to express rules with daughters lists of unspecified length. This, combined with the ability to incorporate definite recursive relations into the grammar provides the grammar writer with a way to implement non-binary grammar rules, such as the head-complement rule, in a concise and elegant manner, which closely approximates “hand-written” grammars. This,

however, does require from the grammar writer the programming skills needed to be able to code using the definite logic programming language.

## 8 Semantic Representation

The LKB contains a module for processing Minimal Recursive Semantics (MRS) representations. The module is independent from the rest of the LKB and provides tools for manipulating MRS structures in feature structure representations (Copestake and Flickinger, 2000). TRALE provides an alternative module which is an implementation of Lexical Resource Semantics (Penn and Richter, 2004). A comparison and evaluation of the two systems will be given in the full paper.

## 9 Evaluating Competence and Performance

Implemented grammars can be evaluated according to two dimensions: competence and performance. The competence of a grammar refers to its coverage and accuracy, that is the ability to account for all and nothing but sentences which are assumed to be grammatical. Performance relates to the resources — mainly processor time and memory space — that are used during processing.

Both the LKB and TRALE provide a way for defining a test suite which can be used as a benchmarking facility. A batch parse returns for each sentence in the test suite the number of parses and passive edges. In terms of performance, TRALE indicates for each sentence the CPU time in seconds that it took to process the sentence. In the LKB only a total figure for all sentences is given. More sophisticated tools for evaluating competence and performance of grammars are available in both systems through the `[incr tsdb()]` package (Open, 2001).

## 10 User-Interface Issues and Features

Aside from major design differences between the two systems, the LKB and TRALE are distinguished by other more superficial user-interface type of differences.

- The LKB provides an interactive display of the grammar's type hierarchy. The user can click on types and examine their immediate and expanded definitions. TRALE produces static images of the hierarchy.
- Both systems provide ways for displaying and inspecting feature structures and syntactic trees. TRALE's Grisu graphical interface displays feature structures in AVMs that are identical to those of "hand-written" HPSG. The LKB display is less compact and more difficult to navigate.
- Parametric macros in TRALE are used as a shorthand for descriptions that are used frequently. Macros are especially useful for defining the lexicon when it is structured to minimize lexeme-specific information.

- The LKB is a graphic-user-interface system where commands are invoked through drop-down menus. In TRALE the user interacts with the program by using commands entered at the Prolog prompt.
- The LKB uses the same syntax to define types, lexical rules, grammar rules, and words in the lexicon. In TRALE distinct formats, similar to “hand-written” HPSG, are used for each of the grammar components.
- The LKB comes with the Matrix (Bender et al., 2002), an open-source starter-kit for rapid prototyping of precision broad-coverage grammars. TRALE grammars need to be implemented from scratch, or based on existing grammars.

## 11 Conclusion

Generally speaking, the characterization of HPSG as an implementable grammatical theory is justified, due to the computational effort that was put into designing and developing the two implementation platforms discussed in this paper. The major gap that was identified between “hand-written” HPSG and its implemented counterpart was in the multi-dimensional inheritance mechanism, which is not incorporated into neither implementation platforms.

The LKB and TRALE can be compared and evaluated along two different axes: FAITHFULNESS and ACCESSIBILITY. Faithfulness is the extent to which the implemented grammar resembles the original “hand-written” one. Accessibility, on the other hand, is the degree of computational skills that is required from a linguist in order to implement a grammar.

In some way, the LKB can be viewed as a simplified TRALE. Thus, when implicational constraints with complex antecedents, DLR lexical rules, the `cats>` operator, definite clauses, and macros are eliminated, one can implement an LKB-like grammar in TRALE. Of course, one LKB feature that cannot be assimilated is the automatic correction of `glb` condition violations.

The gap between the LKB-like TRALE grammar and a grammar implemented using the entire collection of tools provided by TRALE characterizes the differences between the systems. The ‘true’ TRALE grammar is positioned much higher on the faithfulness axis than the LKB-like TRALE grammar. The TRALE tools needed in order to elevate the LKB-like grammar on this axis require from the linguist more computational skills. This is especially true when writing (and debugging) Prolog definite clauses to express relational constraints.

In terms of accessibility, the menu-driven user interface of the LKB is more user-friendly than TRALE’s command-line interface, making the LKB more attractive to the less computationally savvy linguist. However, tipping the balance a little on the accessibility scale towards TRALE is its AVM display, which is much easier to process than the LKB’s. Consequently, a computational linguist interested in implementing an HPSG theory must consider these dimensions when choosing an implementation platform.

## References

- Bender, Emily M., Flickinger, Daniel P. and Oepen, Stephan. 2002. The Grammar Matrix: An Open-Source Starter-Kit for the Rapid Development of Cross-Linguistically Consistent Broad-Coverage Precision Grammars. In John Carroll, Nelleke Oostdijk and Richard Sutcliffe (eds.), *Proceedings of the Workshop on Grammar Engineering and Evaluation at the 19th International Conference on Computational Linguistics*, pages 8–14, Taipei, Taiwan.
- Copestake, Ann. 2002. *Implementing Typed Feature Structure Grammars*. Stanford, CA: CSLI publications.
- Copestake, Ann and Flickinger, Dan. 2000. An Open Source Grammar Development Environment and Broad-coverage English Grammar Using HPSG. In *Proceedings of the 2nd International Conference on Language Resources and Evaluation*, Athens, Greece.
- Melnik, Nurit. 2002. *Verb-Initial Constructions in Modern Hebrew*. Ph.D.thesis, University of California at Berkeley.
- Meurers, Detmar. 1994. On Implementing an HPSG Theory – Aspects of the Logical Architecture, the Formalization, and the Implementation of Head-Driven Phrase Structure Grammars. In Erhard W. Hinrichs, Detmar Meurers and Tsuneko Nakazawa (eds.), *Partial-VP and Split-NP Topicalization in German – An HPSG Analysis and its Implementation*, pages 47–155, Tübingen, Germany: Eberhard-Karls-Universität Tübingen.
- Meurers, Detmar. 2001. On expressing lexical generalizations in HPSG. *Nordic Journal of Linguistics* 24(2), 161–217, special issue on ‘The Lexicon in Linguistic Theory’.
- Meurers, Detmar, Kuthy, Kordula De and Metcalf, Vanessa. 2003. Modularity of grammatical constraints in HPSG-based grammar implementations. In *Proceedings of the ESSLLI '03 workshop “Ideas and Strategies for Multilingual Grammar Development”*, Vienna, Austria.
- Meurers, Detmar and Minnen, Guido. 1997. A Computational Treatment of Lexical Rules in HPSG as Covariation in Lexical Entries. *Computational Linguistics* 23(4), 543–568.
- Meurers, W. Detmar, Penn, Gerald and Richter, Frank. 2002. A Web-based Instructional Platform for Constraint-Based Grammar Formalisms and Parsing. In Dragomir Radev and Chris Brew (eds.), *Effective Tools and Methodologies for Teaching NLP and CL*, pages 18 – 25, New Brunswick, NJ: The Association for Computational Linguistics.



- Oepen, Stephan. 2001. [incr tsdb()] — Competence and Performance Laboratory. User Manual. Technical report, Computational Linguistics, Saarland University, Saarbrücken, Germany, in preparation.
- Penn, Gerald and Hoetmer, Kenneth. 2003. In Search of Epistemic Primitives in the English Resource Grammar. In *Proceedings of the 10th International Conference on Head-Driven Phrase Structure Grammar*, East Lansing, Michigan.
- Penn, Gerald and Richter, Frank. 2004. Lexical Resource Semantics: From Theory to Implementation. In Stefan Müller (ed.), *Proceedings of the HPSG-2004 Conference, Center for Computational Linguistics, Katholieke Universiteit Leuven*, pages 423–443, Stanford: CSLI Publications.
- Pollard, Carl and Sag, Ivan A. 1994. *Head-Driven Phrase Structure Grammar*. CSLI Publications and University of Chicago Press.

# **Adverb extraction and coordination: A reply to Levine**

Ivan A. Sag

Stanford University

Proceedings of the 12th International Conference on  
Head-Driven Phrase Structure Grammar

Department of Informatics, University of Lisbon

Stefan Müller (Editor)

2005

Stanford, CA: CSLI Publications

pages 322–342

Sag, Ivan A. 2005. Adverb extraction and coordination: A reply to Levine. In Stefan Müller (ed.), *Proceedings of the 12th International Conference on Head-Driven Phrase Structure Grammar, Department of Informatics, University of Lisbon*, 322–342. Stanford, CA: CSLI Publications. DOI: 10.21248/hpsg.2005.18.



## Abstract

HPSG accounts of filler-gap dependencies hold considerable potential for explaining the cross-linguistic variation in unbounded dependency constructions (UDCs), specifically filler-gap dependencies. This potential comes from the SLASH specifications that are posited in all nodes along the extraction path (the path between filler and gap). However, as Hukari and Levine (1994, 1995, 1996) have observed, the HPSG analysis presented by Pollard and Sag (1994) fails to embody the generalizations required in order to explain key universal properties of UDCs, in particular the ‘registration’ of such dependencies in cases of subject- and adverb-extraction. This demonstration led Bouma et al. (2001) to propose a revised UDC analysis that avoids these difficulties by ‘threading’ the SLASH specifications through all heads within an extraction domain. However, Levine (2002) points out that this analysis encounters a new difficulty concerning the interaction of extraction and coordination. This paper revisits these issues, arguing that a small modification of the BMS analysis provides a solution to the important problem observed by Levine.

## 1 Introduction

### 1.1 Pollard and Sag 1994

Pollard and Sag (1994) [Henceforth PS94] proposed a theory of UDCs which, following earlier work in GPSG, guarantees that nonempty specifications for the feature SLASH appear throughout a syntactic structure. Their theory, which includes a Nonlocal Inheritance Principle to guide the inheritance of SLASH specifications and a Trace Principle to constrain the distribution of traces, posits structures like the one shown in Figure 1. *Wh*-subject clauses in the PS94 analysis involve no SLASHed categories, as shown in Figure 2. And the extraction of embedded subjects, because it is treated via a lexical rule sanctioning derivations like (1), involves UNSLASHed embedded VPs like the lower VP in Figure 2.

$$(1) \begin{bmatrix} \text{PHON} & \langle \textit{think} \rangle \\ \text{SUBCAT} & \langle \textit{NP}, \textit{S} \rangle \\ \text{SLASH} & \{ \} \end{bmatrix} \Rightarrow_{LR} \begin{bmatrix} \text{PHON} & \langle \textit{think} \rangle \\ \text{SUBCAT} & \langle \textit{NP}, \textit{VP} \left[ \text{SUBCAT} \left\langle \left[ \text{LOC} \underline{1} \right] \right\rangle \right] \rangle \\ \text{SLASH} & \{ \underline{1} \} \end{bmatrix}$$

---

<sup>†</sup>I’d like to thank Gosse Bouma, Bob Kasper, Bob Levine, Rob Malouf, Stefan Müller, and Carl Pollard for discussion of the ideas presented in this paper. I’m particularly indebted to Bob Levine for extended discussions and helpful suggestions. Please don’t blame any of them for my mistakes. Thanks again to Stefan for patient editing . . .

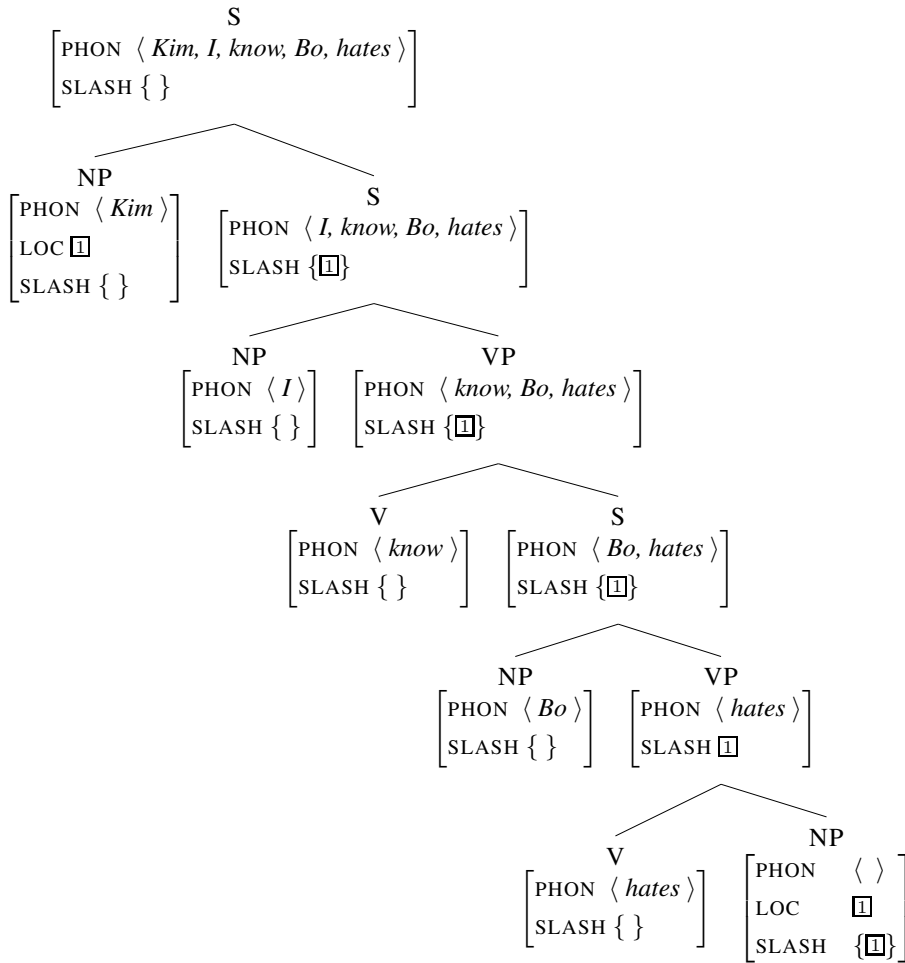

Figure 1: A Topicalization structure, as analyzed by PS94

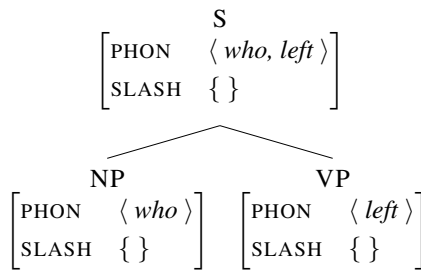
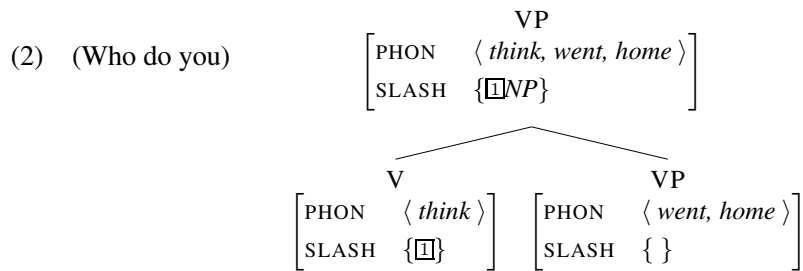
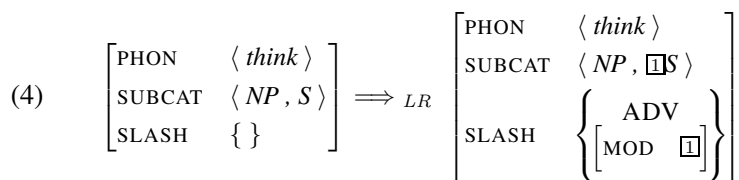

Figure 2: *Who left*, as analyzed by PS94



The PS94 analysis of adverb extraction is similarly piecemeal. Matrix adverb fronting like (3a) involves no SLASHed constituents at all, and ‘long-distance’ adverb fronting like (3b) is handled via a lexical rule that sanctions derivations like the one sketched in (4):

- (3) a. Yesterday, we drank genever.  
 b. Yesterday, they think we drank genever.



In virtue of such lexical-rule outputs, the SLASH path terminates with the matrix V, even when a fronted adverbial modifies an embedded clause, as in (5):

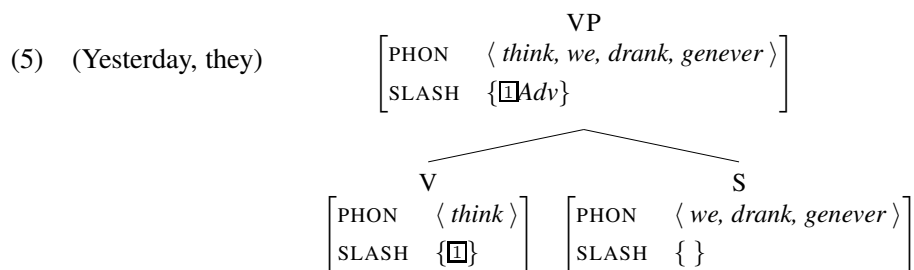

But we know that many languages register UDCs (more precisely, *extraction paths*) – in diverse ways: via verb morphology, complementizer choice, otherwise impossible inversions, or even suppression of tonal downstep. In Irish, for example, the complementizer *aL* appears only in an extraction path, while *goN* is the complementizer that must appear outside the extraction path (and in sentences without any extraction dependencies at all). This is illustrated in (6):<sup>1</sup>

<sup>1</sup>For relevant discussion, see McCloskey 1979, 1990, 2002, from which I draw freely.

- (6) a. Dúirt mé **gurL** shíl mé **goN** mbeadh sé ann.  
 said I goN.PAST thought I COMP would-be he there  
 ‘I said that I thought that he would be there.’
- b. an fear **aL** shíl mé **aL** bheadh \_ ann  
 the man COMP thought I COMP would-be \_ there  
 ‘the man that I thought would be there’
- c. an fear **aL** dúirt mé **aL** shíl mé **aL** bheadh \_ ann  
 the man COMP said I COMP thought I COMP would-be \_ there  
 ‘the man that I said I thought would be there’
- d. an fear **aL** shíl \_ **goN** mbeadh sé ann  
 the man COMP thought \_ COMP would-be he<sub>j</sub> there  
 ‘[the man]<sub>j</sub> that thought he<sub>j</sub> would be there’
- e. an fear **aL** dúirt sé **aL** shíl \_ **goN** mbeadh sé ann  
 the man COMP said he COMP thought \_ COMP would-be he there  
 ‘the man that he said thought he would be there’

Chamorro verb morphology is sensitive not only to the presence of an extraction path, but also to the grammatical function of the element that is extracted (or from which such an element is extracted):

- (7) a. Hayi **fum-a’gasi** i kareta  
 who WH.SU-wash the car  
 ‘Who washed the car?’
- b. Hayi si Juan **ha-sangan-i** hao [ **fum-a’gasi** i kareta ]  
 who UNM Juan E3S-say-DAT you WH.SU-wash the car  
 ‘Who did Juan tell you washed the car?’
- c. Hafa **um-istotba** hao [ ni **malagao’-na** i lahi-mu ]  
 what WH.SU-disturb you COMP WH.OBL-want-3sg the son-your  
 ‘What does it disturb you that your son wants?’

Similar phenomena are found in numerous languages. The ones I am familiar with as of this writing are the following: Irish Complementizer Alternations (McCloskey 1979, 1990, 2002), Chamorro Verb Morphology (Chung 1982, 1995, 1998), Palauan Verb Morphology (Georgopoulos 1985, Chung & Georgopoulos 1988), Icelandic Expletive Subjects (Maling & Zaenen 1978), Kikuyu Downstep Suppression (Clements 1984), French Stylistic Inversion (Kayne & Pollock 1978), Spanish Stylistic Inversion (Torrego 1984), Yiddish Verb Inversion (Diesing 1990), Ulster English Quantifier Floating (McCloskey 2000), Afrikaans (Du Plessis 1977), Thompson Salish Verb Agreement<sup>2</sup> (Kroeger 1997). In all such

<sup>2</sup>The Thompson phenomenon discussed by Kroeger may submit to a substantially different kind of analysis that does not require lexical sensitivity to UDCs.

cases, it should be straightforward to construct an HPSG analysis based on the distinction between SLASHed and unSLASHed constituents. For example, the Irish complementizer alternation illustrated above can be simply analyzed by letting *aL* (whether analyzed as a functional head or as a marker) select for a SLASHed clause, while *goN* selects for an unSLASHed clause (or else, if further data is taken into consideration, selects for a clause that is unspecified for SLASH).

However, as Tom Hukari and Bob Levine (HL) have shown at length, the PS94 analysis of UDCs does not lend itself to a straightforward account of the relevant cross-linguistic details. HL observe two important universal generalizations about the registration of UDCs. The first concerns subject extraction:

- (8) Hukari and Levine (1994, 1996): In languages where extraction is registered, the extraction of a verb's subject is registered.

Recall from section 1 that in the case of matrix *wh*-clauses, PS94 posit no SLASHed elements at all. And in the case of the extraction of embedded subjects, the lower VP and its V are both unSLASHed. Hence, if the account of extraction registration is based on SLASHed elements, PS94 fails to provide a description of subject extraction at all, since verbs whose subjects are extracted are all unSLASHed, as are the elements these verbs combine with. If PS94 were adapted to Irish, for example, it would incorrectly predict that embedded subject extraction should occur with only *goN*, not *aL* in the lowest clause of examples like (6b,c).

The second generalization isolated by HL concerns adjunct extraction:

- (9) Hukari and Levine (1995): In all languages where extraction is registered, extraction of adjuncts is registered.

This phenomenon, illustrated for Irish in (10), is also problematic for the analysis of UDCs in PS94.

- (10) a. Ceén uair **aL** tháinig siad 'na bhaile \_  
           which time<sub>j</sub> COMP came they home *t<sub>j</sub>*  
           'what time did they come home'  
       b. Ceén fáth **aL** dhúirt tú **aL** tháinig sé \_  
           which reason<sub>j</sub> COMP said you COMP came he *t<sub>j</sub>*  
           'why did you say he came'

If verbs of saying, thinking, etc. are themselves SLASHed, but select an unSLASHed complement (as in (5)) then here too we should expect to find *goN* in the lowest clause of the extraction domain, not *aL*. This prediction is falsified by examples like (10b).

## 1.2 BMS 2001

Bouma, Malouf and Sag's (2001) [BMS's] HPSG analysis of UDCs offers a solution to these problems. BMS were influenced by the work of Przepiór-kowski

(1999a,b,c) and others, who provide considerable evidence for the idea that many adverbials in diverse languages should be analyzed as complements selected by a verbal head, rather than as adjuncts that select for a VP constituent. Any proposal along these lines puts adverbials in a position comparable to that of complements. This opens the door to an analysis of extracted adverbials that is on a par with the analysis of extracted complements. For example, a verb may morphologically register the fact that its adverbial complement is extracted in the same way that it registers complement extraction. If adverbial extraction can be assimilated to extracted complements, then the SLASH-based analysis of extraction registration can easily be maintained.

Another influence on BMS was the fact that the existence of *wh*-traces had been called into question. Sag and Fodor (1994) present arguments undermining the claims that had previously been made in favor of the existence of *wh*-traces and Sag (2000) offers new challenges to the existence of such traces, arguing that theoretically critical coordinate structure extraction restrictions follow naturally if it is assumed that there are no phonetically unexpressed elements in *wh*-trace position.

These two factors led BMS to an analysis that lacks *wh*-traces, and where both subjects and adverbs are selected by the verb. Once all such elements are lexically selected, it is straightforward, as BMS show, for a particular morphological verb class to require extraction of a particular dependent, to disallow such extraction, or to be indifferent to such matters.

BMS introduced the feature DEP(ENDENTS) in addition to ARGUMENT-STRUCTURE and the VALENCE features. The values of these features are interdependent, i.e. they are constrained by the following two general principles:

(11) Argument Structure Extension:

$$\left[ \begin{array}{l} \textit{word} \\ \text{SS|L|CAT|HD } \textit{verb} \end{array} \right] \Rightarrow \left[ \begin{array}{l} \text{SS|L} \\ \text{CAT} \left[ \begin{array}{l} \text{HD} \quad \boxed{3} \\ \text{ARG-ST} \quad \boxed{A} \\ \text{DEPS} \quad \boxed{A} \oplus \text{LIST} \left( \left[ \text{MOD} \left[ \begin{array}{l} \text{HD} \quad \boxed{3} \\ \text{KEY} \quad \boxed{2} \end{array} \right] \right] \right) \\ \text{CONT|KEY} \quad \boxed{2} \end{array} \right] \end{array} \right]$$

(12) Dependent Realization:

$$\textit{word} \Rightarrow \left[ \begin{array}{l} \text{SS|L|CAT} \\ \text{VAL} \left[ \begin{array}{l} \text{SUBJ} \quad \boxed{A} \\ \text{COMPS} \quad \boxed{B} \ominus \text{list}(\textit{gap-ss}) \end{array} \right] \\ \text{DEPS} \quad \boxed{A} \oplus \boxed{B} \end{array} \right]$$

According to these principles, feature structures like the following are all licensed:



- (13) a. 
$$\left[ \begin{array}{l} \text{SS|L|CAT} \\ \left[ \begin{array}{l} \text{HEAD} \quad \textit{verb} \\ \text{VAL} \quad \left[ \begin{array}{l} \text{SUBJ} \quad \langle \boxed{1}\text{NP} \rangle \\ \text{COMPS} \quad \langle \boxed{2}\text{NP} \rangle \end{array} \right] \\ \text{DEPS} \quad \langle \boxed{1}, \boxed{2} \rangle \\ \text{ARG-ST} \quad \langle \boxed{1}, \boxed{2} \rangle \end{array} \right] \end{array} \right]$$
- b. 
$$\left[ \begin{array}{l} \text{SS|L|CAT} \\ \left[ \begin{array}{l} \text{HEAD} \quad \textit{verb} \\ \text{VAL} \quad \left[ \begin{array}{l} \text{SUBJ} \quad \langle \boxed{1}\text{NP} \rangle \\ \text{COMPS} \quad \langle \boxed{2}\text{NP}, \boxed{3}\text{'advbl'} \rangle \end{array} \right] \\ \text{DEPS} \quad \langle \boxed{1}, \boxed{2}, \boxed{3} \rangle \\ \text{ARG-ST} \quad \langle \boxed{1}, \boxed{2} \rangle \end{array} \right] \end{array} \right]$$
- c. 
$$\left[ \begin{array}{l} \text{SS|L|CAT} \\ \left[ \begin{array}{l} \text{HEAD} \quad \textit{verb} \\ \text{VAL} \quad \left[ \begin{array}{l} \text{SUBJ} \quad \langle \boxed{1}\text{NP} \rangle \\ \text{COMPS} \quad \langle \rangle \end{array} \right] \\ \text{DEPS} \quad \langle \boxed{1}, \boxed{2} \left[ \begin{array}{l} \textit{gap-ss} \\ \text{NP} \end{array} \right] \rangle \\ \text{ARG-ST} \quad \langle \boxed{1}, \boxed{2} \rangle \end{array} \right] \end{array} \right]$$
- d. 
$$\left[ \begin{array}{l} \text{SS|L|CAT} \\ \left[ \begin{array}{l} \text{HEAD} \quad \textit{verb} \\ \text{VAL} \quad \left[ \begin{array}{l} \text{SUBJ} \quad \langle \boxed{1}\text{NP} \rangle \\ \text{COMPS} \quad \langle \boxed{2}\text{NP} \rangle \end{array} \right] \\ \text{DEPS} \quad \langle \boxed{1}, \boxed{2}, \boxed{3} \left[ \begin{array}{l} \textit{gap-ss} \\ \text{'advbl'} \end{array} \right] \rangle \\ \text{ARG-ST} \quad \langle \boxed{1}, \boxed{2} \rangle \end{array} \right] \end{array} \right]$$
- e. 
$$\left[ \begin{array}{l} \text{SS|L|CAT} \\ \left[ \begin{array}{l} \text{HEAD} \quad \textit{verb} \\ \text{VAL} \quad \left[ \begin{array}{l} \text{SUBJ} \quad \langle \boxed{1}\text{NP} \rangle \\ \text{COMPS} \quad \langle \rangle \end{array} \right] \\ \text{DEPS} \quad \langle \boxed{1} \left[ \begin{array}{l} \textit{gap-ss} \\ \text{NP} \end{array} \right], \boxed{2} \rangle \\ \text{ARG-ST} \quad \langle \boxed{1}, \boxed{2} \rangle \end{array} \right] \end{array} \right]$$

(13e) corresponds to the case of subject extraction, because, following Ginzburg and Sag (2000, Ch. 6), there is a construction admitting clauses whose only daughter is a VP whose unexpressed subject is a gap.<sup>3</sup>

<sup>3</sup>Unwanted verbs with non-singleton SUBJ values are ruled out by the constraint in (i):

$$(i) \left[ \begin{array}{l} \textit{word} \\ \text{SS|L|CAT} \left[ \begin{array}{l} \text{HEAD} \quad \textit{verb} \end{array} \right] \end{array} \right] \Rightarrow \left[ \text{SS|L|CAT|VAL|SUBJ} \quad \langle [ ] \rangle \right]$$

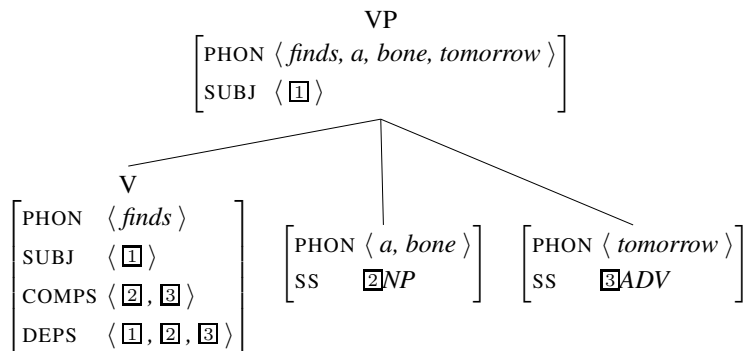
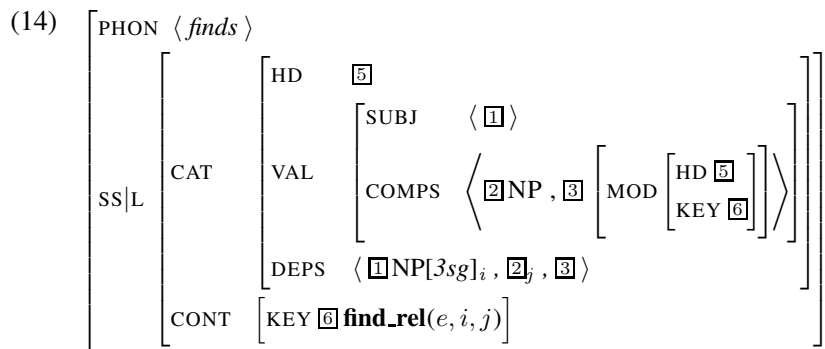

Figure 3: BMS 2001 analysis of an adjunct as complement

In the BMS analysis, the adverb selected by a verb has a MOD value whose KEY value is identified with the verb's KEY value, according to the Argument Structure Extension principle. This allows instantiated lexical entries like the one sketched in (14):



This in turn gives rise to head-complement structures like the one in Figure 3. This syntactic analysis is straightforward. However, as we will see later, the semantic analysis that BMS assumed is inadequate in a number of crucial respects.

To handle extraction, BMS appealed to the SLASH Amalgamation Constraint first proposed by Sag (1997):

And, finally, the Principle of Canonicity, which requires that all signs are canonical, works together with the various grammar rules to ensure that noncanonical members of an ARG-ST list are never locally realized.

(15) SLASH Amalgamation Constraint:

$$word \Rightarrow \left[ \begin{array}{l} SS \left[ \begin{array}{l} LOC \left[ \begin{array}{l} CAT \left[ \begin{array}{l} DEPS \langle [SLASH \ 1], \dots, [SLASH \ n] \rangle \\ BIND \ 0 \end{array} \right] \\ NL|SLASH \ (1 \cup \dots \cup n) \ominus 0 \end{array} \right] \end{array} \right] \end{array} \right]$$

This works together with a simple approach to SLASH inheritance, where in the general case, the head daughter and its mother simply share their SLASH specifications, as in (16):

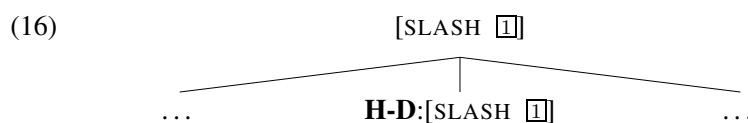

In gap-binding constructions, however, the head daughter's SLASH value is 'cancelled off', leaving the mother with a smaller SLASH value, as shown in (17):

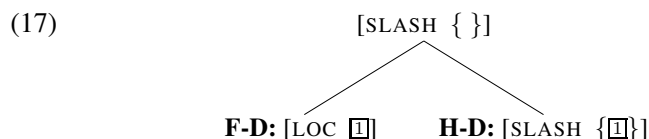

The BMS proposal allows complement-extraction and subject-extraction to be treated via structures like those in Figure 4 and in (18):

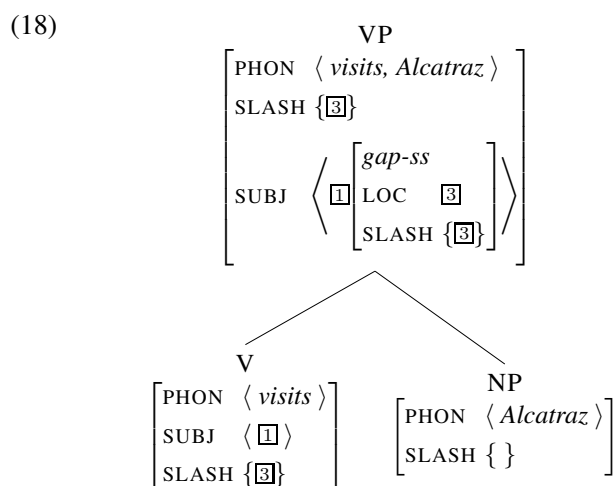

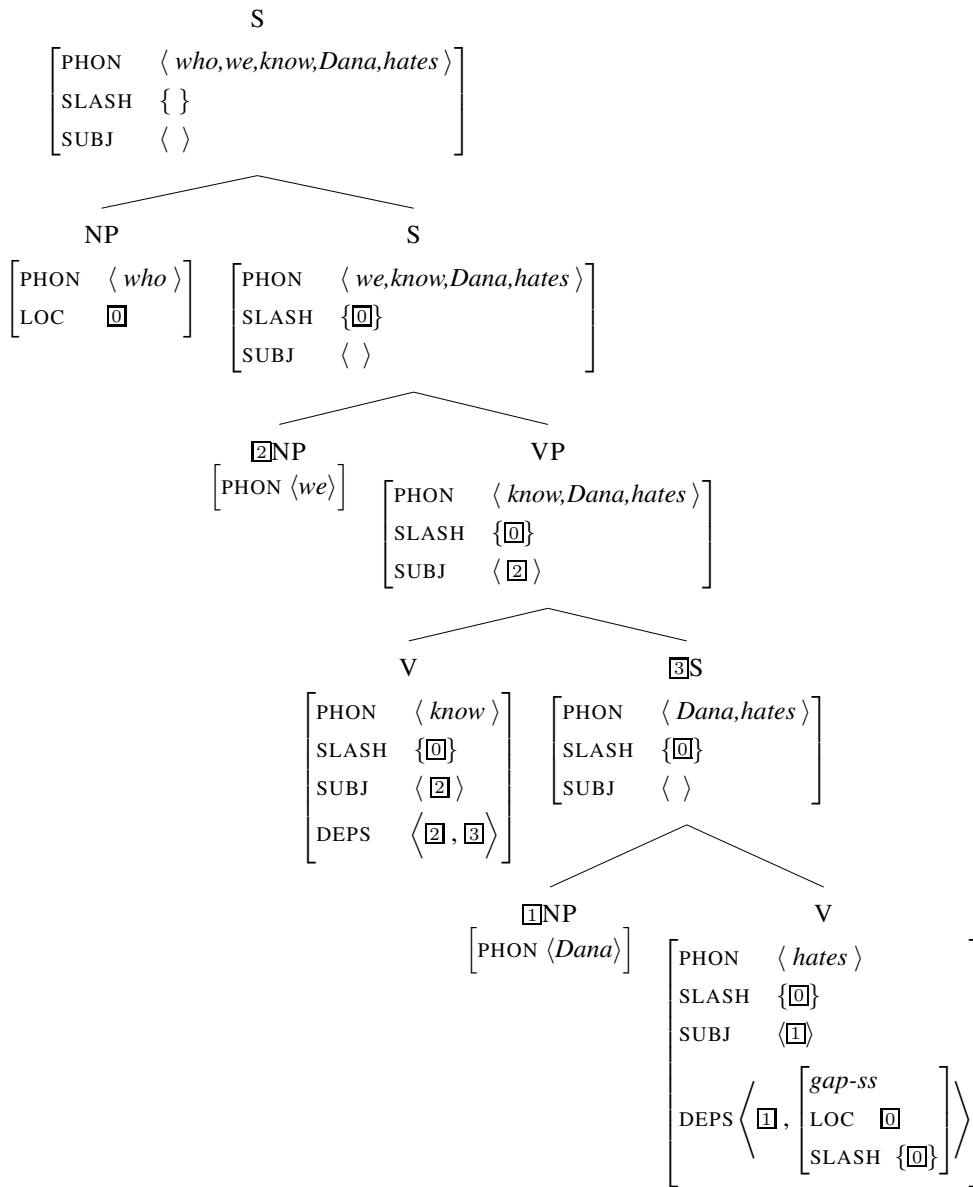

Figure 4: Complement extraction, as analyzed in BMS 2001

Note that all verbs along the extraction path in Figure 4 are SLASHed, as is the verb whose subject is extracted in (18). Unlike the PS94 analysis of extraction, the BMS proposal distributes SLASH precisely where the languages discussed earlier register complement and subject extraction.

Now, when an adverbial is on a verb's DEPS list, one option is for it to be of type *gap-ss*. But all feature structures of this type must be SLASHed in the BMS analysis,<sup>4</sup> hence verbs selecting unrealized adverbials must themselves be SLASHed (by SLASH-Amalgamation), as shown in (19):

$$(19) \left[ \begin{array}{l} \text{PHON} \langle \textit{visits} \rangle \\ \\ \text{SS} \left[ \begin{array}{l} \text{LOC|CAT} \left[ \begin{array}{l} \text{VAL} \left[ \begin{array}{l} \text{SUBJ} \langle \boxed{1}\text{NP}[\text{SLASH } \boxed{2}] \rangle \\ \text{COMPS} \langle \boxed{3}\text{NP}[\text{SLASH } \boxed{4}] \rangle \end{array} \right] \\ \text{DEPS} \langle \boxed{1}, \boxed{3}, \left[ \begin{array}{l} \textit{gap-ss} \\ \text{LOC} \quad \boxed{5} \\ \text{SLASH} \quad \{\boxed{5}\} \end{array} \right] \rangle \\ \text{ARG-ST} \langle \boxed{1}, \boxed{3} \rangle \\ \text{NL|SLASH } \boxed{2} \cup \boxed{4} \cup \{\boxed{5}\} \end{array} \right] \end{array} \right] \end{array} \right]$$

And this in turn gives rise to adverb-extraction structures like the one in Figure 5. Thus, the extraction of an adverb is registered on all verbs of the extraction path (the path between the adverbial and its 'gap'). The BMS analysis of UDCs registers the extraction dependency in all the places that it is morphologically, lexically, tonologically or syntactically registered in the languages considered above, correcting the inadequacies of the PS94 extraction analysis.

## 2 A Semantic Problem and its Solution

**The Problem.** Despite its attractiveness, the BMS analysis of UDCs encounters certain difficulties. For example, Levine (2002) poses the question of whether the BMS analysis can be reconciled with examples like (20):

- (20) In how many seconds flat did Robin find a chair, sit down, and whip off her logging boots?

Because in the BMS analysis, an adverb selected by a verb identifies its MOD value's KEY value with the verb's KEY value, (20) poses a dilemma: if the extracted adverb is associated with a dependent of each verb (*find*, *sit*, and *whip*), then three contradictory KEY values must be equated. Intuitively, (20) requires that the adverb modify the coordinate structure (since this sentence has a cumulative reading and its meaning is a question about the duration of a tripartite event),

<sup>4</sup>The constraint that ensures this is:  $\textit{gap-ss} \Rightarrow \left[ \begin{array}{l} \text{LOC } \boxed{1} \\ \text{NL|SLASH } \{\boxed{1}\} \end{array} \right]$ .

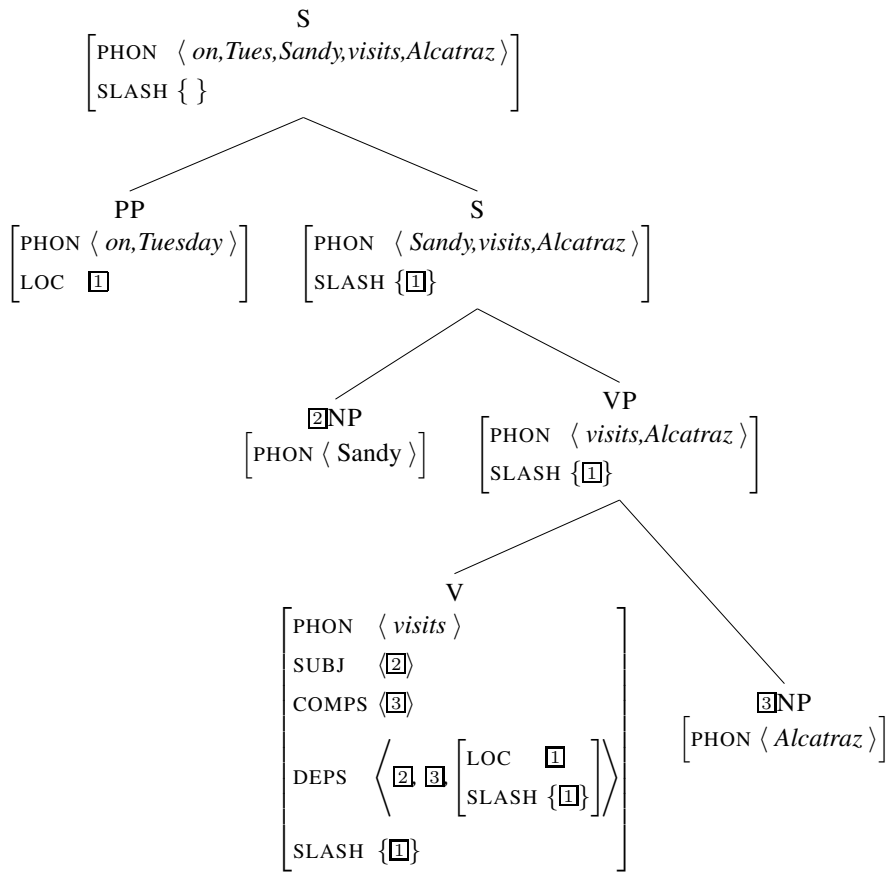

Figure 5: Adjunct extraction, as analyzed by BMS 2001

yet the BMS analysis assumes that all postverbal adverbials are complements, and hence it lacks any way to associate the adverb with the appropriate adjunct position, and no way to assign it the correct scope. On the other hand, Levine argues, if there are adverbial traces that can appear wherever adverbs can appear (as in the PS94 analysis), then these examples are unproblematic – the adverbial trace is in a position adjoined to the coordinate structure, and hence outscopes the conjunction.

**A Revision of the BMS Analysis.** Since returning to the PS94 analysis leaves us without an account of the Hukari-Levine generalizations noted earlier, it seems prudent to seek a revision of the BMS analysis that provides a solution to the problem noted by Levine. In the remainder of this paper, I explore what I believe is a relatively minor modification of the BMS analysis that resolves this problem without introducing traces of the sort that Levine argues would provide an alternative account of data like (20).

Bouma et al. (in unpublished work) already observed that the BMS analysis requires a stipulation stated in terms of a binary relation they call *successively-out-modify*. This is necessary in order to ensure that the linear order of postverbal adjuncts determines their relative scope:

(21) Robin reboots the Mac [frequently] [intentionally]. **intnl(freq(reboot..))**

(22) Robin reboots the Mac [intentionally] [frequently]. **freq(intnl(reboot..))**

This unattractive stipulation can be eliminated by returning to a lexical-rule (LR)-based analysis like that originally proposed by van Noord and Bouma (see also Przepiórkowski 1999). For convenience, I will formulate this lexical rule as a unary schema that simply extends a verb’s ARG-ST list, i.e. as in (23), where the daughter is the ‘LR input’ and the mother is the ‘LR output’:<sup>5</sup>

(23) Adverb Addition Schema:

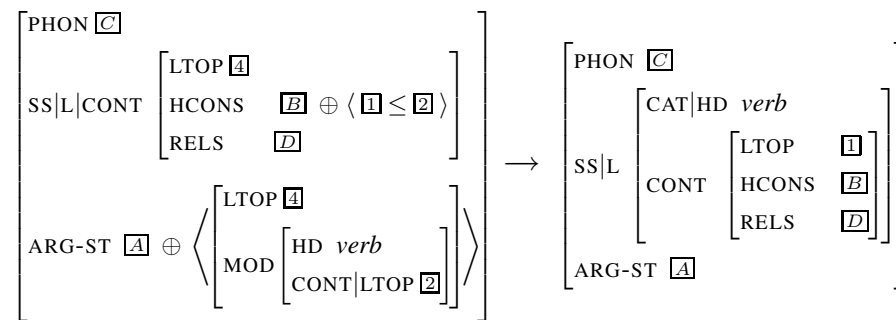

<sup>5</sup>This replaces the Argument Structure Extension principle given in (11). I am aware that by eliminating DEPS, I raise controversial issues about the role of binding theory in the treatment of Principle C effects, but these are orthogonal to the matters at hand. I follow Copetake et al.’s presentation of MRS throughout. In particular, lexical constraints are assumed to ensure that the local top (a handle) of a verb or a scopal adverb is equal to that of its predication, modulo quantifiers (= *q*).

In (24), I also formulate this LR in terms of the construction theory laid out in Sag to appear (see in addition Sag et al. 2003, Ch. 16), where constructs are treated as feature structures:

$$(1) \left[ \begin{array}{l} \text{MOTHER} \\ \text{DTRS} \end{array} \left[ \begin{array}{l} \text{PHON } \boxed{C} \\ \text{SS|LOC|CONT} \left[ \begin{array}{l} \text{LTOP } \boxed{4} \\ \text{HCONS } \boxed{B} \oplus \langle \boxed{1} \leq \boxed{2} \rangle \\ \text{RELS } \boxed{D} \end{array} \right] \\ \text{ARG-ST } \boxed{A} \oplus \left\langle \begin{array}{l} \text{LTOP } \boxed{4} \\ \text{MOD} \left[ \text{LOC} \left[ \begin{array}{l} \text{CAT|HEAD } \textit{verb} \\ \text{CONT|LTOP } \boxed{2} \end{array} \right] \right] \end{array} \right\rangle \end{array} \right] \\ \left\langle \begin{array}{l} \text{PHON } \boxed{C} \\ \text{SS|LOC} \left[ \begin{array}{l} \text{CAT|HEAD } \textit{verb} \\ \text{CONT} \left[ \begin{array}{l} \text{LTOP } \boxed{1} \\ \text{HCONS } \boxed{B} \\ \text{RELS } \boxed{D} \end{array} \right] \end{array} \right] \\ \text{ARG-ST } \boxed{A} \end{array} \right\rangle \end{array} \right]$$

The constraint in (23) requires that the local top ( $\boxed{4}$ ) of the selected adverb is also the verb's local top. In addition, it ensures that the local top ( $\boxed{1}$ ) of the daughter verb is less than or equal to the adverb's MOD value's local top ( $\boxed{2}$ ). This means that when a verb combines with a scopal adverbial complement, the verb's predication will always be within the scope of that adverbial, as shown in (24). In addition, selected adverbials must be able to modify verbal expressions (hence the [HEAD *verb*] specification in the adverbial's MOD value: (Note that no further LOC, CAT, SUBCAT or HEAD identity is enforced.)

$$(2) \left[ \begin{array}{l} \text{PHON } \langle \textit{found} \rangle \\ \text{SS|LOC|CONT} \left[ \begin{array}{l} \text{LTOP } h_4 \\ \text{RELS} \left\langle \begin{array}{l} \textit{find-rel} \\ \text{LBL } h_1 \\ \text{ARG1 } i \\ \text{ARG2 } j \end{array} \right\rangle \\ \text{HCONS } \langle h_1 \leq h_2 \rangle \end{array} \right] \\ \text{ARG-ST} \left\langle \text{NP}_i, \text{NP}_j, \left[ \begin{array}{l} \text{LTOP } h_4 \\ \text{MOD} \left[ \text{LOC} \left[ \begin{array}{l} \text{CAT|HEAD } \textit{verb} \\ \text{CONT|LTOP } h_2 \end{array} \right] \right] \end{array} \right] \right\rangle \end{array} \right]$$



Here the selected adverb, if scopal, will have to include the verb's local top, and hence the verb's predication, within its scope. The use of  $\leq$ , rather than  $=_q$  (the only relation used by Copestake et al. (in press)), is crucial to this analysis.

Notice that the mother in (22) (the 'LR output') says nothing about the KEY value of the verb or that of the MOD value. In addition, when a verb selects two adverbials, the first adverbial's local top enters into an  $\leq$  relation with the local top of the second adverbial's MOD value. This ensures that subsequent scopal adverbials will always outscope prior adverbials (and that all such adverbials will include the verb's predication in their scope).

The only two resolved mrs-s that satisfy the constraints imposed by (23) for an example like (24a) are shown in (24b,c):

(3) a. Kim found a chair in 30 seconds.

b. 
$$\left[ \begin{array}{l} \text{LTOP } h_0 \\ \text{RELS } \langle h_1:\text{found}(k,y), h_2:a(y,h_3,h_1), h_3:\text{chair}(y), h_0:\text{in-30-secs}(h_2) \rangle \end{array} \right]$$

**in-30-secs(a (y, chair(y), found(k,y)))**

c. 
$$\left[ \begin{array}{l} \text{LTOP } h_0 \\ \text{RELS } \langle h_4:\text{found}(k,y), h_0:a(y,h_3,h_1), h_3:\text{chair}(y), h_1:\text{in-30-secs}(h_4) \rangle \end{array} \right]$$

**a (y, chair(y), in-30-secs( found(k,y)))**

The handle ( $h_0$ ) of the quantifier  $a$  is within the preposition's scope in (23b), but outside it in (23c).

It is important to understand that the adverbial complement's scope remains 'clause-bounded' under this proposal. A verb like *believe* or *try* selects a verbal phrase as complement and lexically identifies the local top of the relevant complement with the appropriate semantic argument (the second argument of *believe-rel* or *try-rel*). Since a VP's local top will be identified with that of the rightmost adverbial in an example like (24), all of the adverbs must be within the scope of the embedding handle-embedding relation:

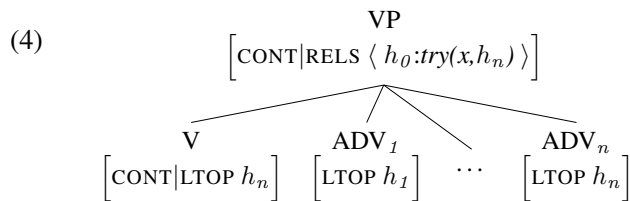

In short, my proposal entails that the scope interactions of selected scopal adverbials parallel that of true adjuncts, but in the opposite order. (see Copestake et al. (in press) discussion of *Kim apparently almost succeeded*, which has only an **apparently(almost(succeeded(k)))** reading.

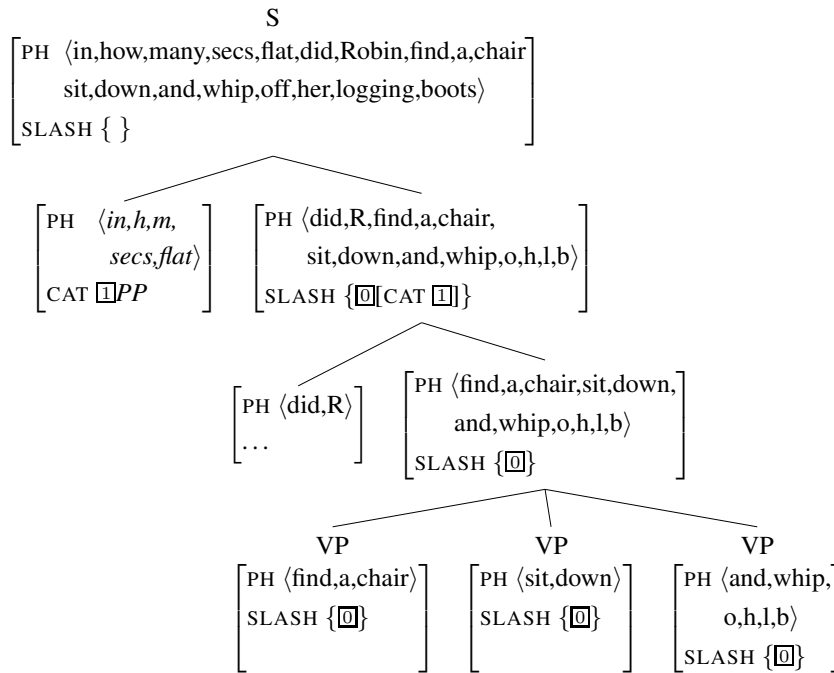

Figure 6: Extracted adjunct scopes over coordination

**Extracted Adverbials Scope over Conjunctions.** The proposal just made bears on the problem raised by Levine. In head-filler constructions of all sorts, it is reasonable to assume that the filler daughter’s CAT and INDEX values are identified with those of the head daughter’s SLASH member.<sup>6</sup> Now reconsider Levine’s example in (20) above. In this case, the CAT and INDEX values of the adverbial filler (the PP *in how many minutes flat*) will be identified with those of the member of the SLASH set, which will in turn (via standard HPSG principles governing the inheritance of SLASH specifications) be identified with the SLASH members of the selected adverbials, as sketched in Figure 6.

The SLASH values also make their way down to the verbs *find*, *sit*, and *whip*, where they are amalgamated from the selected adverbial, as in the BMS analysis. Making familiar assumptions about gaps, the CAT value of each selected adverbial is identified with the CAT value of its SLASH value. Since MOD is within CAT, it follows that the filler’s MOD value must outscope each verbal predication.

Following Copestake et al. (in press), I assume that conjunctions embed the local tops of the conjuncts as their arguments, roughly as in Figure 7.

<sup>6</sup>Given MRS, it would be an unwanted complication to identify the entire CONT value of filler and the gap in a UDC. Identifying the LTOP of the filler daughter with that of the SLASH value would also impose unwanted scope restrictions when the filler is scopal.

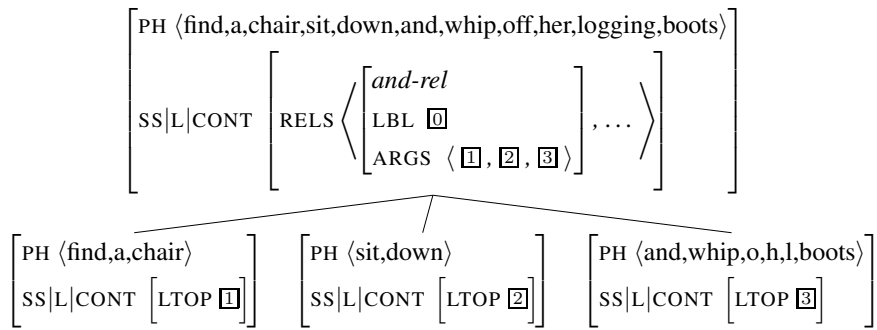

Figure 7: Local tops in coordinate adjunct-extraction structure

Since each conjunct’s local top is embedded as an argument of the conjunction, the only way the filler adverbial can simultaneously outscope *find-rel*, *sit-rel*, and *whip-rel* is for that adverbial to outscope the *and-rel* (since, given the nature of MRS, the adverbial’s relation can only appear once in a resolved *mrs* structure). The correct scoping thus results from the resource-sensitive nature of MRS. Assuming a variant of *and-rel* that provides the appropriate cumulative event interpretation discussed by Levine, his example (20) is properly analyzed, as sketched in (24):

$$(24) \quad \left[ \begin{array}{l} \text{LTOP } h_0 \\ \text{RELS } \langle h_0:\textit{how-many}(x,h_1,h_2), h_1:\textit{second}(x), h_2:\textit{in}(h_3,x), \\ h_3:\textit{and}(h_4,h_5,h_6), h_4:\textit{a}(y,h_7,h_8), h_7:\textit{chair}(y), h_8:\textit{found}(k,y), \\ h_5:\textit{sit-down}(k), h_6:\textit{whip-off-h-l-boots}(k) \rangle \end{array} \right]$$

Note that the use of  $\leq$ , rather than  $=_q$  (as in Copestake et al. in press), is crucial, as this is what allows the *and-rel* to ‘slip in’ to the resolved *mrs* structure. Also crucial is the fact that only CAT and INDEX information is identified in a UDC. That is, in a filler-gap structure like (4), because MOD is a HEAD feature and HEAD is within CAT, it follows that the MOD value of the fronted adverb is identified with the adverb on the verb’s ARG-ST list, and this is sufficient to guarantee that a fronted scopal adverb will always outscope the verb whose adverbial argument is extracted. However, nothing identifies the LTOP of the sentence-initial adverb with that of the adverbial on the verb’s ARG-ST (which is in fact identified with the verb’s LTOP by the constructional constraint in (1) above). When the verb combines with an adverbial complement by a head-complement construction, a stronger identity is enforced (synsem identity, let us assume) and this will include LTOP identity. Hence a locally selected adverbial, i.e. a complement, will have local scope, but an extracted adverbial will have more scope possibilities, as discussed above.

The question remains of how to deal with other examples involving adverbs that follow a coordinate-structure, e.g. (25) from Levine 2002. Exactly the same

analysis developed above extends to these examples if they are analyzed in terms of a rightward extraction scheme of the sort that would also treat examples like (26a), where a left-adjoined (true) adjunct is within the scope of the extracted PP.

- (25) Robin [found a chair, sat down, and whipped off her logging boots]  
[in twenty seconds flat].
- (26) a. Sandy [[rarely visited a friend] because of illness].  
b. Sandy [rarely [visited a friend because of illness]].

The **because (rarely ...)** reading associated with (26a) is associated with the rightward extraction of the *because*-phrase. This should be contrasted with the **rarely (because ...)** reading associated with (26b), where the *because*-phrase is directly realized as a complement of *visited* and *rarely* modifies the resulting VP.

Alternatively, the ellipsis-based theory of right-node raising developed by Beavers and Sag (2004) could also provide an analysis of examples like (25). Since MOD is within HEAD, their constraint (27) already guarantees that a common right-peripheral element outscopes all conjuncts. The modification required in order to deal with (25) is to extend their ‘Optional Quantifier Merger’ principle to include adverbial relations. Space limitations prevent me from exploring this option here.

### 3 Conclusion

It appears that the traceless adverb-as-complement analysis can be reconciled with coordination. The revision of the BMS analysis I have presented here gives a principled answer to the important question raised by Levine about the interaction of adverbial extraction and cumulative conjunction, while at the same time providing a coherent, unified approach for systematizing the massive evidence for the ‘Adjuncts-as-Complements’ approach provided by van Noord and Bouma (1994), Przepiórkowski 1999a,b,c, Manning et al. and others. Here I have modified the BMS analysis in three ways: (1) by eliminating DEPS, (2) returning to van Noord and Bouma’s lexical rule analysis of adverb addition, and (3) introducing  $\leq$  constraints. In so doing, I have preserved the elegant account that BMS provide of Hukari and Levine’s (1995) observation that adverb and subject extraction are both morphosyntactically registered in languages that locally register extraction dependencies.

### References

- Abeillé, A. and Godard, D. 2000. French Word Order and Lexical Weight. In R. Borsley (ed.), *The Nature and Function of Syntactic Categories*, pp 325–358, New York: Academic Press.

- Abeillé, A. and Godard, D. 2001. A Class of Lite Adverbs in French. In J. Camps and C. Wiltshire (eds.), *Romance Syntax, Semantics and their L2 Acquisition*, pp 9–25, Amsterdam: J. Benjamins.
- Beavers, J. and Sag, I. A. 2004. Coordinate Ellipsis and Apparent Non-Constituent Coordination. In S. Müller (ed.), *Proceedings of the HPSG-2004 Conference*, pp 48–69, Stanford: CSLI Publications, <http://csli-publications.stanford.edu/HPSG/5/>.
- Bonami, O., Godard, D. and Marandin, J.-M. 1999. A Linearization-Based Approach to French Subject Inversion in Extraction Contexts. In G. Bouma, E. W. Hinrichs, G.-J. M. Kruijff and R. T. Oehrle (eds.), *Constraints and Resources in Natural Language Syntax and Semantics*, pp 21–40, Stanford: CSLI Publications.
- Bouma, G., Malouf, R. and Sag, I. A. 2001. Satisfying Constraints on Extraction and Adjunction. *NLLT* 19(1), 1–65.
- Chung, S. 1982. Unbounded Dependencies in Chamorro Grammar. *LI* 13, 39–77.
- Chung, S. 1995. *Wh*-Agreement and “Referentiality” in Chamorro. *LI* 25, 1–44.
- Chung, S. and Georgopoulos, C. 1988. Agreement with Gaps in Chamorro and Palauan. In M. B. and C. A. Ferguson (eds.), *Agreement in Natural Language: Approaches, Theories, Descriptions*, Stanford: CSLI Publications.
- Clements, G. N. 1984. Binding Domains in Kikuyu. *Studies in the Linguistic Sciences* 14, 37–56.
- Copestake, A., Flickinger, D., Pollard, C. and Sag, I. A. In Press. Minimal Recursion Semantics: an Introduction. *Research on Language and Computation*.
- Diesing, M. 1990. Verb Movement and the Subject Position in Yiddish. *NLLT* 8, 41–79.
- Du Plessis, H. 1977. *Wh*-Movement in Afrikaans. *LI* 8, 723–726.
- Georgopolous, C. 1985. Variables in Palauan Syntax. *NLLT* 3, 59–94.
- Ginzburg, J. and Sag, I. A. 2001. *Interrogative Investigations: the Form, Meaning, and Use of English Interrogatives*. Stanford: CSLI Publications.
- Haik, I. 1990. Anaphoric, Pronominal and Referential INFL. *NLLT* 8, 347–374.
- Hukari, T. E. and Levine, R. D. 1994. Toward a Homogeneous Approach to Extraction Phenomena. Conference on Head-Driven Phrase Structure Grammar. Copenhagen.
- Hukari, T. E. and Levine, R. D. 1995. Adjunct Extraction. *J. of Linguistics* 31(2), 195–226.
- Hukari, T. E. and Levine, R. D. 1996. Phrase Structure Grammar: the Next Generation. *J. of Linguistics* 32, 465–496.
- Kayne, R. and Pollock, J.-Y. 1978. Stylistic Inversion, Successive Cyclicity, and Move NP in French. *LI* 12, 93–133.
- Kroeger, P. 1997. Relativization in Thompson River Salish. *Anthropological Linguistics* 39, 376–422.
- Levine, R. D. 2003. Adjunct valents: cumulative scoping adverbial constructions and impossible descriptions. In J. Kim and S. Wechsler (eds.), *The Proceed-*

- ings of the 9th International Conference on HPSG, pp 209–232, Stanford: CSLI Publications, <http://csli-publications.stanford.edu/HPSG/3/>.
- Maling, J. and Zaenen, A. 1978. The Non-Universality of a Surface Filter. *LI* 9, 475–497.
- Manning, C. D., Sag, I. A. and Iida, M. 1999. The Lexical Integrity of Japanese Causatives. In R. D. Levine and G. M. Green (eds.), *Studies in Contemporary Phrase Structure Grammar*, pp 39–79, Cambridge: Cambridge University Press.
- McCloskey, J. 1979. *Transformational Syntax and Model Theoretic Semantics*. Dordrecht, Boston, London: D. Reidel Publishing Company.
- McCloskey, J. 1990. Resumptive Pronouns,  $\bar{A}$ -Binding, and Levels of Representations in Irish. In R. Hendrick (ed.), *The Syntax of the Modern Celtic Languages*, pp 199–248, New York: Academic Press.
- McCloskey, J. 2000. Quantifier Float and *Wh*-Movement in an Irish English. *LI* 31, 57–84.
- McCloskey, J. 2002. Resumption, Successive Cyclicity, and the Locality of Operations. In S. Epstein and D. Seeley (eds.), *Derivation and Explanation*, pp 184–226, Oxford, UK/Cambridge, USA: Blackwell Publishers.
- Pickering, M. and Barry, G. 1991. Sentence Processing without Empty Categories. *Language and Cognitive Processes* 6, 229–259.
- Przepiórkowski, A. 1999a. *Case Assignment and the Complement-Adjunct Dichotomy: A Non-Configurational Constraint-Based Approach*. Ph.D.thesis, Eberhard-Karls-Universität Tübingen, Germany.
- Przepiórkowski, A. 1999b. On Case Assignment and “Adjuncts as Complements”. In G. Webelhuth, J.-P. Koenig and A. Kathol (eds.), *Lexical and Constructional Aspects of Linguistic Explanation*, pp 231–245, Stanford: CSLI Publications.
- Przepiórkowski, A. 1999c. On Complements and Adjuncts in Polish. In R. D. Borsley and A. Przepiórkowski (eds.), *Slavic in Head-Driven Phrase Structure Grammar*, pp 183–210, Stanford: CSLI Publications.
- Sag, I. A. 1997. English Relative Clause Constructions. *J. of Linguistics* 33(2), 431–484.
- Sag, I. A. 2000. Another Argument Against *Wh*-Trace. Jorge Hankamer Webfest. <http://ling.ucsc.edu/Jorge/sag.html>.
- Sag, I. A. and Fodor, J. D. 1994. Extraction Without Traces. In R. Aranovich, W. Byrne, S. Preuss and M. Senturia (eds.), *Proceedings of the Thirteenth West Coast Conference on Formal Linguistics*, Stanford University: CSLI Publications/SLA.
- Torrego, E. 1984. On Inversion in Spanish and Some of Its Effects. *LI* 15, 103–129.
- van Noord, G. and Bouma, G. 1994. The Scope of Adjuncts and the Processing of Lexical Rules. In COLING Staff (ed.), *Proceedings of COLING 94*, pp 250–256, Kyoto, Japan: ACL – Association for Computational Linguistics.

# Selectional restrictions in HPSG: *I'll eat my hat!*

Jan-Philipp Soehn 

University Tübingen

Proceedings of the 12th International Conference on  
Head-Driven Phrase Structure Grammar

Department of Informatics, University of Lisbon

Stefan Müller (Editor)

2005

Stanford, CA: CSLI Publications

pages 343–353

Soehn, Jan-Philipp. 2005. Selectional restrictions in HPSG: *I'll eat my hat!* In Stefan Müller (ed.), *Proceedings of the 12th International Conference on Head-Driven Phrase Structure Grammar, Department of Informatics, University of Lisbon*, 343–353. Stanford, CA: CSLI Publications. DOI: 10.21248/hpsg.2005.19.



## Abstract

This contribution is concerned with integrating the phenomenon of selectional restrictions in HPSG. Firstly, the question of treating selectional restrictions purely in the semantic module is tackled, as there are some contextual (or pragmatic) influences, which can repair the ill-formedness of violated selectional restrictions. Secondly, we present existing approaches to selectional restrictions within the framework and, lastly, make our own proposal which describes the subject as part of the semantics-pragmatics interface. In particular, we show how a semantic ontology can be integrated.

## 1 Introduction

The phenomenon of selectional restrictions, first described by Chomsky (1965, pp. 114ff), is part of almost every introduction to linguistics. A violation of selectional restrictions is the explanation for the oddity of the following examples:<sup>1</sup>

- (1) <sup>†</sup>*Kim ate a motor-bike.*
- (2) <sup>†</sup>*There is an apple bathing in the water.*

The verb *eat* requires an *edible* object and the action of *bathing* can be fulfilled only by an *animate* actor. Consider further examples showing that the choice of possible arguments can vary with different verbs.

- (3) *The dog is drowning.; The philodendron is drowning.;* <sup>†</sup>*The bacon dumpling is drowning.*
- (4) *The dog barks.;* <sup>†</sup>*The philodendron barks.;* <sup>†</sup>*The bacon dumpling barks.*

Even though the view about the role of selectional restrictions is rather diversified, there is general agreement about the central point of compatibility between verbs and their arguments.<sup>2</sup>

Implemented in a natural language processing system, selectional restrictions help with parsing, word-sense disambiguation and the resolving of anaphora. The word *star* in the sentence “*The astrologer married a star*” is ambiguous between “famous person” and “celestial body”. However, the example can be disambiguated because we know that the object of *marry* must be *human*. In the opposite way, the exact meaning of the polysemous verb *shoot* can be disambiguated by the object it takes:

---

<sup>†</sup>The research to the paper was funded by the *Deutsche Forschungsgemeinschaft*. I am grateful to Stefan Müller, Frank Richter, Christine Römer, Manfred Sailer, the reviewers and the audience of HPSG'05 for insightful comments and discussion and Janah Putnam for help with the challenges of English.

<sup>1</sup>A superscript exclamation mark indicates a violation of selectional restrictions.

<sup>2</sup>Selectional restrictions play a role with adjectives and nouns, too. In this contribution we will confine ourselves with the discussion of verbs.



(5) *He shot the rabbit.* vs. *He shot the picture.*

Selectional restrictions also are responsible for zeugmatic effects:

(6) *Are you getting fit or having one?* (from the television program M\*A\*S\*H)

A characteristic of selectional restrictions is that they are language-specific. This can be illustrated by the verbs *drive* and *ride* and their German counterparts *fahren* and *reiten*. Consider the following data:<sup>3</sup>

- (7) a1) *Kim drives a truck/car/ <sup>1</sup>motor-bike/  
          <sup>1</sup>bike/<sup>1</sup>horse*  
      a2) *Kim rides a <sup>1</sup>truck/<sup>1</sup>car/motor-bike/  
          bike/horse*  
      b1) *Ute fährt ein(en) Lastwagen/Auto/  
          Motorrad/Fahrrad/<sup>1</sup>Pferd*  
      b2) *Ute reitet ein(en) <sup>1</sup>Lastwagen/<sup>1</sup>Auto/  
          <sup>1</sup>Motorrad/<sup>1</sup>Fahrrad/Pferd*

Whereas in English *drive* means a locomotion by operating a motorized vehicle having more than three wheels, the German *fahren* is not sensitive to the number of wheels of the vehicle. The English word *ride* denotes a locomotion while sitting on a saddle or seat like on a horse, the German counterpart *reiten* can be said only for riding on the back of an animal. Thus, selectional restrictions are part of language-dependent lexical information.

Does violation of selectional restrictions always result in an ungrammatical utterance? The answer is no. In metonymic, metaphoric or idiomatic utterances, selectional restrictions may be violated:

(8) *She puts the wine on the table, right next to the glasses.*

A metonymy can be found in example (8), for the object of *put* is the container (e. g. a bottle), rather than the substance.

As a *book* is not *edible*, violating the selectional restriction of *devour*, we understand (9) as being metaphoric:

(9) *He devoured the book in one single night.*

Within idioms we can find violations of selectional restrictions, too. As was pointed out by Soehn and Römer (2004), this could be counted as a marker for a non-free reading. Take for example:

(10) *to pour out one's grief to someone*

(11) *juicy/spicy bits of gossip*

---

<sup>3</sup>The German examples are a nearly word-by-word translation, therefore they are not glossed.

Firstly, in (10), the object of the verb *to pour out* must be a container, which doesn't hold for *grief*. Secondly, *bits of gossip* cannot be *juicy* or *spicy* in the literal sense, for *gossip* is abstract. Thus, the violation of selectional restrictions allows us to recognize a nonliteral meaning.

Information from selectional restrictions mark sentences as odd only if one has in mind the lexical meaning of the words and a "normal" context of utterance. This means that there is nothing inherently wrong with a sentence such as (1), because the reader only has to imagine a suitable context (e.g. eating chocolate motor-bikes). In addition, there are certain contextual features that render expressions like *ate a motor-bike* perfectly grammatical. These "repairing contexts" (cf. Chomsky, 1965, p. 158 and Androutsopoulos and Dale, 2000, p. 1) neutralize violations of selectional restrictions and the sentence is fully interpretable:

- (12) a) <sup>!</sup>*Kim ate a motor-bike.*  
b) *Kim did not eat a motor-bike.*  
c) *One cannot eat motor-bikes.*  
d) *Kim tries to eat a motor-bike./Kim believes/dreams that she can eat motor-bikes.*  
e) *I'll eat my hat if Kim ate a motor-bike.*  
f) *Did Kim really eat a motor-bike?*

The repairing contexts are negation (12 b), modals and negation (c), non-factive verbs as *believe*, *try*, etc. whose arguments introduce a state-of-affairs in a possible – not the actual – world (d), conditionals (e) and questions (f).<sup>4</sup> Thus, a violation of selectional restrictions is highly context sensitive. Therefore, Androutsopoulos and Dale argue that selectional restrictions are a pragmatic phenomenon.

To sum up, we have so far seen that, on the one hand, selectional restrictions are part of the lexical information. On the other hand, a violation of selectional restrictions does not mean that the expression becomes totally uninterpretable, but some context features may repair the violation or a suitable context-of-utterance even renders the expression perfectly inconspicuous. In our view, one can account for these facts best when regarding the phenomenon of selectional restrictions as part of the semantics-pragmatics-interface.

## 2 Selectional Restrictions in HPSG

### 2.1 Previous Approaches

There are not many publications about selectional restrictions in HPSG. We only know about those of Nerbonne (1996) and Androutsopoulos and Dale (2000).

---

<sup>4</sup>Chomsky (1965, p. 158) also mentions meta-linguistic expressions like *It is not a good idea to eat motor-bikes*.

In his article, Nerbonne focuses on topics which are related to the processing of semantic information. In order to disambiguate the sense of *chair* in the example “*The chair decided on Mary*” he introduces a new feature M-AGT for “mental agent” within the semantics module. Thus one can distinguish between the two meanings “piece of furniture” and “head of organization”. However, the author does not make clear what other features would be necessary and a worked-out concept of selectional or sortal constraints is far beyond the focus of Nerbonne’s contribution.

A more concrete proposal for handling selectional restrictions is described by Androutsopoulos and Dale (op. cit.). The authors describe two alternative approaches. In their first proposal Androutsopoulos and Dale adopt a pragmatic point of view, putting all relevant information about a verb’s selectional restrictions on the BACKGROUND set of the verb. They argue that selectional restrictions belong to the non-literal information, which is always situated in CONTEXT BACKGROUND, in contrast to literal information, which is to be handled in the CONTENT. For this approach the authors need an inferencing component which compares the relevant signs to rule out signs corresponding to readings that violate a selectional restriction. This “constraint-satisfaction reasoning” would have to be pipe-lined after the parser of a natural language processor, because the information comes from a semantic hierarchy and has to be compared with the arguments present.

In their alternative approach, Androutsopoulos and Dale treat selectional restrictions exclusively within CONTENT. They introduce a sortal hierarchy below *index*. The INDEX value of the object of *eat* can thus be constrained to be of sort *edible*. This approach is more efficient for NLP applications (cf. Müller and Kasper (2000) for an analogous account within Verbmobil). However, it yields an immediate failure of analysis when there is a violation of selectional restrictions and so does Nerbonne’s proposal. Neither approach takes into account the effect of a repairing context. In a similar vein, Ben-Avi and Francez (2004) propose to combine information from a semantic ontology with a type-logical grammar. Unfortunately, their analysis within the framework of Categorical Grammar does not take into account repairing contexts either.

## 2.2 Our Proposal

As we have argued above, the phenomenon of selectional restrictions can be best accounted for by regarding it as part of the semantics-pragmatics-interface. The idea is to put the relevant information into the BACKGROUND set (BGR) of the CONTEXT of a sign and use structure-sharing with respective semantic indices. Contrary to the first proposal by Androutsopoulos and Dale (op. cit.) we introduce a semantic hierarchy with new sorts and relations as part of every *unembedded-sign*. Thus, we avoid the need for a separate inferencing component.

Unembedded signs are potential stand-alone utterances. According to Richter (2004, ch. 2.1.2), they are empirical objects and central to linguistic research. Richter argues already in (1997, ch. 5.2) that a more fine-grained distinction of

*signs* is necessary. In the signature which he develops, every subsort of *sign* can occur as an embedded and as an unembedded version. Major differences between embedded and unembedded signs are that the latter do not contain any unbound traces (if one assumes that traces exist) and that they have illocutionary force.

As a first step, we define two new elements to figure on the BGR set. These are, following standard assumptions, subsorts of *psoa*.

$$\left[ \begin{array}{l} \textit{sel-restr-imp} \\ \text{ARG} \quad \textit{index} \\ \text{MUST-SATISFY} \quad \textit{selection-sort} \end{array} \right] \left[ \begin{array}{l} \textit{sel-restr-stf} \\ \text{ARG} \quad \textit{index} \\ \text{SATISFIES} \quad \textit{selection-sort} \end{array} \right]$$

The first *psoa* can be introduced to BGR by signs which impose a selectional restriction.<sup>5</sup> A verb, e. g. *eat*, can subcategorize for a noun with a certain restriction. Nouns such as *apple* satisfy this restriction.<sup>6</sup> They have also included this information in their BGR set.

The phrase „... *eats apples*“ is sketched in Fig. 1. The collection of all elements in all BGR sets is guaranteed by the CONTEXTUAL-CONSISTENCY-PRINCIPLE (Pollard and Sag, 1994, p. 333), which exists independently of our proposal.

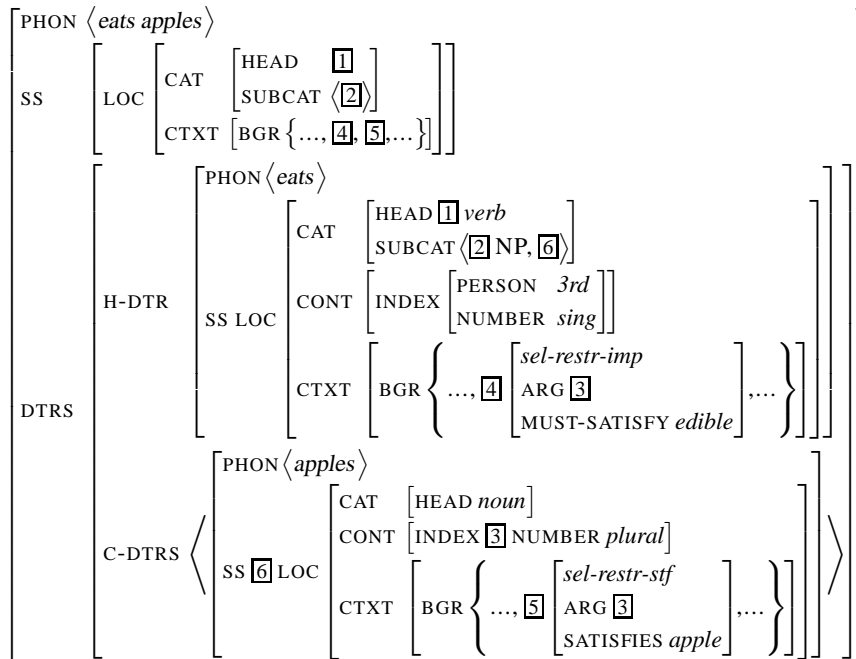

Figure 1: Phrase including selectional restrictions

As a second step we introduce a principle which ensures that the values of MUST-SATISFY (M-STF) and SATISFIES (STF) in the CTXT BGR set are compatible. To be compatible means that the STF value of the argument of *eat* is either identical

<sup>5</sup>*sel-restr-imp* for imposed

<sup>6</sup>*sel-restr-stf* for satisfies

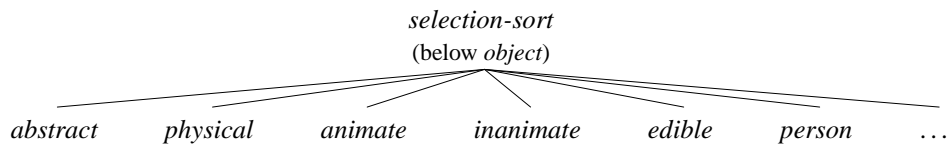

Figure 2: The sort *selection-sort*

to the M-STF value of the verb itself, or that the STF value is a sub-element of the M-STF value in a semantic ontology. In other terms, the verb only requires an edible object, whereas the object itself can be more concrete – a pancake or a banana.

The principle should license only phrases which have compatible values of M-STF and STF – but only if the argument or the whole proposition is outside the scope of a negational, a conditional or a question-operator. As stated above, these contexts “repair” the effect of a violation of selectional restrictions.

(13) VALIDITY-PRINCIPLE OF SELECTIONAL RESTRICTIONS (VPSR, preliminary version):

If in a phrase  $x$  there is a sign  $s$ , a verb  $v$  ( $s$  is an argument of  $v$ ) and a proposition  $p$ , which is formed by  $v$  and its arguments, and  
 if neither the meaning associated with  $s$  nor the meaning associated with  $p$  are within the scope of a negational operator, a conditional operator or a question-operator or an non-factive verb,  
 then the STF value of a *sel-rest-stf* element in the CTXT BGR set of  $x$  and the M-STF value of a *sel-restr-imp* element that shares the ARG value with *sel-rest-stf* must be compatible.

How can we capture this compatibility formally? The values of M-STF and STF are a subsort of the newly-introduced *selection-sort*, cf. Fig. 2. This sort has a finite number of subsorts such as *abstract*, *physical*, *artifact*, *animate*, *edible*,... which correspond to units of a semantic ontology as in WordNet<sup>7</sup> or GermaNet<sup>8</sup>. In Fig. 3, we roughly sketch such a semantic ontology, including multiple inheritance (sub-units inherit from more than one superunit). In such an ontology the units are related to each other, indicated by the graph-structure. We want to establish such relations between the subsorts of *selection-sort*, too.

A sort hierarchy, as used for the normal HPSG sort inventory, cannot be adopted here. An HPSG formalism for Pollard/Sag-style grammars (as RSRL e.g. Richter et al., 1999) requires that objects be sort-resolved. This allows us to talk about objects having maximally specific sorts on the one hand and about underspecified descriptions (among them lexical entries) on the other. If we had a sort hierarchy for *selection-sort* analogous to the one in Fig. 3, we could not capture generalizations such as, e. g., that *eat* takes something *edible* as its object, for *edible* is not

<sup>7</sup>cf. Christiane Fellbaum, ed. (1998): *Wordnet: An Electronic Lexical Database*. Bradford Books, The MIT Press.

<sup>8</sup>cf. <http://www.sfs.nphil.uni-tuebingen.de/lsc/>

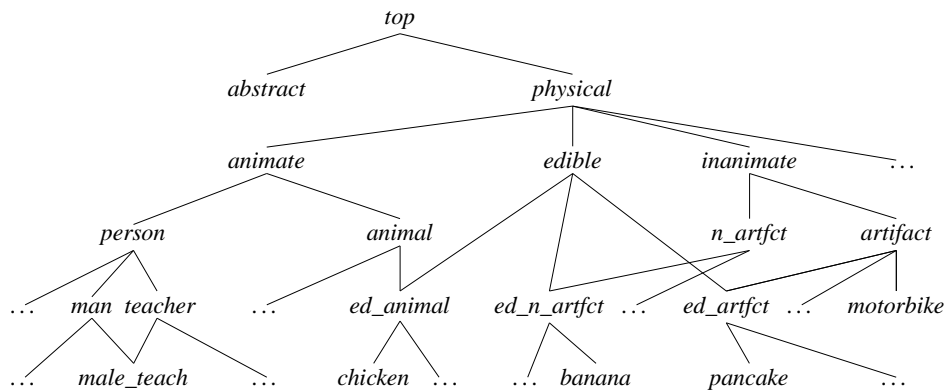

Figure 3: A semantic ontology

maximally specific. To clarify this point, we stick to our example of *eat* with the lexical constraint to have an *edible* object. Consider a concrete utterance “*She eats pancakes.*” where there is a noun-object with  $[_{STF} \textit{pancake}]$ , which is the argument of a verbal object *eat* with an arbitrary, maximally specific value  $[_{M-STF} \textit{banana}]$ . Even though *banana* is a subsort of *edible* (the constraint in the lexical entry of the verb thus is fulfilled), the two sorts *banana* and *pancake* are still incompatible and the selectional restriction seems to be violated. This shows that we need sorts such as *edible*, which are somewhere in the middle of the hierarchy, as values in sort-resolved objects.

Thus we insert the subsorts of *selection-sort* into the signature as depicted in Fig. 2. The relations have to be defined separately, e. g. they can be collected in a list. This list is the value of a new attribute *HIERARCHY*, which we define for all unembedded signs. It contains pairs of subsorts of *selection-sort* being in an “is a”-relation. Formally this is a partial order of the elements below *selection-sort*. The following principle describes the list and defines it as the value of *HIERARCHY* for every unembedded sign.

(14) SELECTION-HIERARCHY-PRINCIPLE (outlined):

$$\begin{array}{l}
 \textit{unembedded-sign} \rightarrow \\
 \left[ \textit{HIERARCHY} \left\langle \left[ \begin{array}{l} \textit{is\_a} \\ \textit{ARG1 animate} \\ \textit{ARG2 animate} \end{array} \right], \left[ \begin{array}{l} \textit{is\_a} \\ \textit{ARG1 animate} \\ \textit{ARG2 person} \end{array} \right], \left[ \begin{array}{l} \textit{is\_a} \\ \textit{ARG1 animate} \\ \textit{ARG2 animal} \end{array} \right], \dots \right\rangle \right]
 \end{array}$$

We do not mean that the *HIERARCHY*, which can easily get quite big, is a genuine “linguistic” part of every unembedded sign. We only want to express the fact that every speaker has access to this kind of knowledge when formulating or hearing an utterance. Technically but not conceptually, this amounts to the same. Defining *HIERARCHY* as a feature of *unembedded-sign* allows us to determine the grammaticality of each unembedded sign without additional context. Thus we do not have to postpone the treatment of selectional restrictions to a separate inferenc-

ing component but we can recognize the semantical ill-formedness immediately for each unembedded sign.

Returning back to our selectional restriction approach, we recapitulate: compatibility of *selection-sorts* means that there is an “is-a”-relation between the values of MUST-SATISFY and SATISFIES. This relation can contain one or more intermediate sorts; it is transitive.

(15) *She drank a sip of the Cabernet Sauvignon 2001.*

This example is about a special kind of wine. *Cabernet Sauvignon* **is** wine, which **is** an alcoholic beverage, which **is** a beverage, which **is** drinkable. The example shows that such an ontology becomes remarkably complex. At this point we have to admit that it is very easy to postulate and outline such ontologies. However, the implementation requires a lot of work, particularly when accounting for all the theoretical and empirical problems such a project raises (for a successful project cf. the one mentioned in footnote 7).

Having formalized the notion of compatibility, we can now reformulate the VPSR in the following way.

(16) VALIDITY-PRINCIPLE OF SELECTIONAL RESTRICTIONS (VPSR, final version):

If in an unembedded sign  $x$  there is a sign  $s$ , a verb  $v$  ( $s$  is an argument of  $v$ ) and a proposition  $p$ , which is formed by  $v$  and its arguments, and if neither the meaning associated with  $s$  nor the meaning associated with  $p$  are within the scope of a negational operator, a conditional operator or a question-operator or an non-factive verb, then the STF value of a *sel-rest-stf* element in the CTXT BGR set of  $x$  and the M-STF value of a *sel-restr-imp* element that shares the ARG value with *sel-rest-stf* must be in a relation on the HIERARCHY list of  $x$ .

### 3 Summary and Further Directions

We have investigated the phenomenon of selectional restrictions and characterized it as being situated on the semantics-pragmatics-interface.

We propose a way to integrate selectional restrictions into HPSG which takes into account the effects of repairing contexts. Restrictions are imposed by the verbs in their lexical entries and have to be satisfied by the verbs' arguments. If the argument is within the scope of a repairing operator, the whole sign is not ungrammatical – it is licensed by the VPSR.<sup>9</sup> Compatibility of *selection-sorts* means that

---

<sup>9</sup>One argument we have disregarded is that a violation of selectional restrictions gets repaired by a certain kind of contexts like fairy tales or science fiction stories. To account for this kind of contextual shift one would have to assume a more fine-grained structure in the CONTEXT and distinguish between a standard context and an active context. Moreover, one would need relations which can take over standard assumptions (footballs are not edible) to the actual context or which can introduce new scenarios (starships can travel faster than light).

there is an “is-a” relation between the values of MUST-SATISFY and SATISFIES. Thus we do not have to postpone the treatment of selectional restrictions to a separate inferencing component but we can recognize the semantical ill-formedness immediately for each unembedded sign.

A further application of our approach might be the handling of metonymy (see e.g. Egg, 2004). It requires a certain amount of world knowledge to understand a metonymic utterance. For example, one has to know that wine, like every other drinkable liquid, is normally stored in a container, which can be placed on a table, cf. (8). Thus, for a metonymic utterance to be felicitous, a certain relation must hold between an element in the utterance and another object, as e.g. *in\_container*, *has\_part* or *consists\_of*. These relations could be defined for all sorts in the HIERARCHY list. As we have already implemented the *is\_a*-relation there, some generalizations can be captured in an elegant way.

Our proposal implies two main lines of further research. Firstly, one could implement the approach adding it to an existing grammar fragment. The greatest portion of work in order to complete this task will be defining the HIERARCHY-list, even if one uses an already worked-out ontology. The exact specification of the VPSR depends on the kind of semantics which is implemented in the grammar fragment. Secondly, carrying out linguistic experiments would, on the one hand, provide judgements about the grammatical status of violated selectional restrictions. On the other hand, psycholinguistic evidence about the effects of repairing contexts could be produced. If it can be shown that there is a difference in processing between examples without a violation of selectional restrictions and a “repaired” violation of selectional restrictions, this would be an indication that we are on the right track.

## References

- Androutsopoulos, Ion and Dale, Robert (2000). Selectional Restrictions in HPSG. In *Proceedings of COLING 2000*, Saarbrücken, pp. 15–20.
- Ben-Avi, Gilad and Francez, Nissim (2004). Categorical Grammar with Ontology-refined Types. In *Proceedings of CG 2004 (Montpellier, France)*. Elsevier.
- Chomsky, Noam (1965). *Aspects of the Theory of Syntax*. MIT Press, Cambridge, MA.
- Egg, Markus (2004). Metonymie als Phänomen der Semantik-Pragmatik-Schnittstelle. *metaphorik.de (Online-Journal)*, ISSN 1618-2006 6, 36–53.
- Müller, Stefan and Kasper, Walter (2000). HPSG Analysis of German. In W. Wahlster (Ed.), *Verbmobil: Foundations of Speech-to-Speech Translation, Artificial Intelligence*, pp. 238–253. Berlin Heidelberg New York: Springer-Verlag.



- Nerbonne, John (1996). Computational Semantics – Linguistics and Processing. In S. Lappin (Ed.), *Handbook of Contemporary Semantic Theory*, pp. 459–482. Blackwell Publishers, London.
- Pollard, Carl and Sag, Ivan A. (1994). *Head-Driven Phrase Structure Grammar*. Stanford University: CSLI/The University of Chicago Press.
- Richter, Frank (1997). Die Satzstruktur des Deutschen und die Behandlung langer Abhängigkeiten in einer Linearisierungsgrammatik. Formale Grundlagen und Implementierung in einem HPSG-Fragment. In E. Hinrichs, D. Meurers, F. Richter, M. Sailer, and H. Winhart (Eds.), *Ein HPSG-Fragment des Deutschen, Teil 1: Theorie*, Number 95 in Arbeitspapiere des SFB 340, pp. 13–187. Universität Tübingen.
- Richter, Frank (2004). *Foundations of Lexical Resource Semantics*. Professorial dissertation (version of 09-24-2004), Eberhard-Karls-Universität Tübingen.
- Richter, Frank, Sailer, Manfred, and Penn, Gerald (1999). A Formal Interpretation of Relations and Quantification in HPSG. In G. Bouma, E. Hinrichs, G.-J. M. Kruijff, and R. Oehrle (Eds.), *Constraints and Resources in Natural Language Syntax and Semantics*, pp. 281–298. Stanford: CSLI Publications.
- Soehn, Jan-Philipp and Römer, Christine (2004). Wann ist ein Idiom ein Idiom? Eine Analyse von Phraseologismen ohne freie Lesart. In *Proceedings of Europhras 2004, Basel*.

# Projecting RMRS from TIGER dependencies

Kathrin Spreyer

Saarland University and DFKI

Anette Frank 

DFKI, Saarbrücken

Proceedings of the 12th International Conference on  
Head-Driven Phrase Structure Grammar

Department of Informatics, University of Lisbon

Stefan Müller (Editor)

2005

Stanford, CA: CSLI Publications

pages 354–363

Spreyer, Kathrin & Anette Frank. 2005. Projecting RMRS from TIGER dependencies. In Stefan Müller (ed.), *Proceedings of the 12th International Conference on Head-Driven Phrase Structure Grammar, Department of Informatics, University of Lisbon*, 354–363. Stanford, CA: CSLI Publications. DOI: 10.21248/hpsg.2005.20.



## Abstract

We present a method for automatic RMRS semantics construction from dependency structures, following the semantic algebra of Copestake et al. (2001). We have applied this method to a subset of the TIGER Dependency Bank for German (Forst et al., 2004) to obtain a semantic treebank for (HPSG) parser evaluation. We describe the semantics construction mechanism and give evaluation figures from manual validation of the treebank. These indicate high precision of the automatic RMRS construction process.

## 1 Introduction

Treebanks are under development for many languages. They are exploited for induction of treebank grammars, training of stochastic parsers, and for evaluating and benchmarking competitive parsing and grammar models. While parser evaluation against treebanks is most natural for treebank-derived grammars, it is extremely difficult for hand-crafted grammars that represent higher-level syntactic or semantic information, such as LFG, HPSG, or CCG grammars (cf. Carroll et al., 2002).

In a recent joint initiative, the TIGER project provides dependency-based treebank representations for German, on the basis of the TIGER treebank (Brants et al., 2002). Forst (2003) applied treebank conversion methods to the TIGER treebank, to derive an f-structure bank for stochastic training and evaluation of a German LFG parser. A more general, theory-neutral dependency representation is currently derived from this TIGER-LFG treebank, to enable cross-framework parser evaluation (Forst et al., 2004). However, while Penn-treebank style grammars and LFG analyses are relatively close to dependency representations (cf. Crouch et al., 2002; Kaplan et al., 2004), the situation is different for grammar formalisms that deliver deeper semantic representations, such as HPSG or CCG.

In order to provide a closer evaluation standard and appropriate training material for German HPSG grammars, we propose a method for semi-automatic construction of an RMRS treebank for German on the basis of the TIGER-Dependency Bank. In contrast to treebanks constructed from the analyses of hand-crafted grammars, this method achieves a gold standard for comparative parser evaluation where the upper bound for coverage is defined by the corpus (here, German newspaper text), not by the grammar.

Our treebank conversion method effectively implements RMRS semantics construction from dependency structures, and can be further developed to a general method for RMRS construction from LFG f-structures, similar to recent work in the LOGON project (Dyvik et al., 2005).

---

<sup>†</sup>The research reported here was conducted in cooperation with the TIGER project and has partially been supported by the project QUETAL (DFKI), funded by the German Ministry for Education and Research, grant no. 01 IW C02. Special thanks go to Dan Flickinger and Berthold Crysmann for advice on theoretical and grammar-specific issues. We also thank Martin Forst, who provided us with the TIGER DB dependency structures, Berthold Crysmann for providing HPSG lexical resources, and Ulrich Sch'affer for XSLT-scripts used for visualisation.

## 2 The TIGER Dependency Bank

The input to the RMRS construction process consists of dependency representations of the TIGER Dependency Bank (TIGER-DB) (Forst et al., 2004). The TIGER-DB is derived from (a subset of) the TIGER treebank. It abstracts away from constituency in order to remain as theory-neutral as possible. The TIGER-DB was derived semi-automatically from the TIGER-LFG Bank of Forst (2003), by defining various normalisations. The dependency format is similar to the Parc 700 Dependency Bank (King et al., 2003). So-called dependency triples are sets of two-place predicates that encode grammatical relations. The arguments represent the head of the dependency and the dependent, respectively. The triples further retain a number of morpho-syntactic features from the LFG representations, such as agreement information for nominals and adjectives, or tense information. Figure 1 displays a sample dependency representation.

```
sb(müssen~0, Museum~1)
case(Museum~1, nom)
gend(Museum~1, neut)
num(Museum~1, sg)
mod(Museum~1, privat~1001)
cmpd_lemma(Museum~1, Privatmuseum)
oc_inf(müssen~0, weichen~3)
mood(müssen~0, ind)
tense(müssen~0, pres)
sb(weichen~3, Museum~1)
```

Figure 1: TIGER-DB structure for *Privatmuseum muss weichen* – Private museum deemed to vanish.

However, dependency structures are difficult to match against the output of HPSG parsing. HPSG analyses do not come with an explicit representation of functional structure, but directly encode semantic structures, in terms of MRS (Copestake et al., 2005) or RMRS (Copestake, 2003). This leaves a gap to be bridged in terms of normalisation of diathesis, the encoding of arguments vs. adjuncts, the representation of constructions like relative clauses, and the representation of quantifiers and their scoping relations.

In order to provide a gold standard that can be matched against the output of HPSG parsing for evaluation, and further, for training stochastic grammar models, we propose a method for treebank conversion that essentially performs RMRS construction from LFG-based dependency representations.

For the purpose of semantics construction, the triples format has both advantages and disadvantages. On the one hand, the LFG-derived dependencies offer all the advantages of a functional as opposed to a constituency-based representation. This representation already filters out the semantically inappropriate status of auxiliaries as heads; their contribution is encoded by features such as *perf* or *fut*, which can be directly translated into features of semantic event variables.

Most importantly, the triples localize dependencies which are not locally realized in terms of phrase structure (as e. g. in control structures, coordination, or long-distance constructions), so that when constructing the semantics from the dependency format, we do not need additional mechanisms to identify the arguments of a governing predicate.

The challenges we face mainly concern the lack of constituency information in the dependency representations. Yet, it is possible to reconstruct important phrase-structural information from the dependency input format (see Section 3.3. below).

### 3 RMRS Construction from TIGER Dependencies

#### 3.1 Treebank Conversion by Term Rewriting

Similar to Forst (2003) we are using the term rewriting system of Crouch (2005) for treebank conversion. Originally designed for Machine Translation, the system is a powerful tool for structure rewriting that is also applied to other areas of NLP, such as the induction of knowledge representations (Crouch, 2005).

The input to the system consists of a set of facts in a prolog-like term representation. The rewrite rules refer to these facts in the left-hand side (LHS), either conjunctively (expressed by separating conjuncts with a comma ‘,’) or disjunctively (expressed by ‘|’). Expressions on the LHS may be negated by a prefixed ‘-’, thereby encoding negative constraints for matching. A rule applies if and only if all facts specified on the LHS are satisfied by the input set of facts. The right-hand side (RHS) of a rewrite rule defines a conjunction of facts which are added to the input set of facts if the rule applies. The system further allows the user to specify whether a matched fact will be consumed (i. e., removed from the set of facts) or whether it will be retained in the rule’s output set of facts (marked by the prefix ‘+’).

The processing of rules is *strictly ordered*. The rules are applied in the order of textual appearance. Each rule is tested against the current input set of facts and, if it matches, produces an output set of facts that provides the input for the next rule in sequence. Each rule applies concurrently to all distinct sets of matching facts, i.e. it performs parallel application in case of alternative matching facts.

The system offers powerful rule encoding facilities, in terms of macros and templates. These abstraction means help the user to define rules in a perspicuous and modular way.

#### 3.2 RMRS Construction

Within the formal framework of HPSG, every lexical item defines a complete RMRS structure. Semantics composition rules are defined in parallel with syntactic composition. In each composition step, the RMRSs of the daughters are combined according to strict semantic composition rules, to yield the RMRS representation of the phrase (cf. Copestake et al., 2001). Following the scaffolding of

the syntactic structure in this way finally yields the semantic representation of the sentence.

For our task, the input to semantics construction is a dependency structure. As established by work on Glue Semantics (Dalrymple, 1999), semantics construction from dependency structures can in similar ways proceed recursively, to deliver a semantic projection of the sentence. However, the resource-based construction mechanism of Glue Semantics leads to alternative derivations in case of scope ambiguities. In contrast to Glue, we target an underspecified semantic representation. Although usually defined on phrasal configurations, the algebra for (R)MRS construction as defined in Copestake et al. (2001) is neutral with regard to the syntactic representation, and can be transposed to composition on the basis of dependency relations, much alike the Glue framework.

Yet, the rewriting system we are using is not suited for a recursive application scheme: the rules are strictly ordered, and each rule simultaneously applies to all facts that satisfy the constraints. That is, the RMRS composition cannot recursively follow the composition of dependents in a given input structure.

**The RMRS Skeleton.** RMRS construction is thus designed around one *global RMRS*, featuring a TOP label, a RELS set containing the *elementary predications* (EPs), a set HCONS of *handle constraints* which state restrictions on possible scopes, and a set of ING constraints that represent the *in-group* relation.<sup>1</sup>

When defining composition, instead of projecting and accumulating RMRS constraints step-wise by recursive composition rules from the lexical items to the top level of the sentence, at each step we directly insert all EPS, ING and HCONS constraints into the global RMRS, i.e. the RMRS with the top handle. The semantics composition rules are thus reduced to the inherent semantic operations of the algebra of Copestake et al. (2001): the binding of argument variables and encoding of scope constraints. These basic semantic operations are defined by appropriate definitions and operations on the HOOK features in the composition rules.

**Lexical RMRSs.** The notion of *lexical RMRSs* as it is defined here slightly differs from the standard one. If semantic composition proceeds along a tree structure, lexical RMRSs are constructed at the leaf nodes. In our scenario, a lexical RMRS is projected from the PRED features in the dependency structures, irrespective of any arguments, which are considered by subsequent composition rules.

We define the lexical RMRSs in two steps: First, the hook label is (freely) instantiated and thus available for reference to this RMRS by other rules. Second, the hook variable and the basic semantics (EPs for the relation and the ARG0, at least) are introduced on the basis of the predicate's category. This category information is not explicit in the dependencies, but it can be induced from the

---

<sup>1</sup>Whenever two handles are related via an ing constraint, they can be understood to be conjoined. This is relevant, e.g., for intersective modification, since a quantifier that outscopes the modified noun must also take scope over the modifier.

```

(a)  add_ep(Lb,Type,Feat,Val) ::
      +rels(_,Rels)
==> ep(Rels,EP), type(EP,Type),
      lb(EP,Lb), complex_term(Feat,EP,Val).

(b)  +pred(X,Pred), -mo(_,X), -spec(_,X),
      +'s::'(X,SemX), +hook(SemX,Hook), +lb(Hook,Lb)
==> var(Hook,Var)
&&  add_ep(Lb,ep_rel,rel,Pred)
&&  add_ep(Lb,ep_arg0,arg0,Var).

(c)  [ TOP      handle
      REELS    { ..., [ Riese_n
                       LB      h
                       ARG0    x ], ... }
      HCONS    { ... }
      ING      { ... } ]

```

Figure 2: (a) Expansion of `add_ep` template, (b) a rule with a template call, (c) the output lexical RMRS.

grammatical function borne by the predicate, as well as the presence or absence of certain morphological features.

Figure 2 shows a sample lexical RMRS and the rule that yields it: The rule in (b) applies to predicates, i.e. to `pred` features, with a value `Pred` and a hook label `Lb`. In the RHS, one EP is added for the relation represented by `Pred`, and one for the `ARG0`, which is identified with the hook variable.<sup>2</sup>

**Composition.** The semantic composition of arguments and functors makes use of a predicate `arg/3` which encodes the argument structure of the predicates.<sup>3</sup> Given a predicate `arg(Fctor,N,Arg)`, the binding of the argument to the functor is steered by the previously defined hooks of the two semantic entities in that the matching rule attaches an EP with an attribute `ARGN` to the externalized label in the functor’s hook. The value of the attribute `ARGN` is the hook variable of the argument. A slightly more complicated example is shown in Figure 3, it features the introduction of an additional proposition and a scope constraint. This rule binds a declarative (marked by the complementizer *dass*) finite clausal object (`oc_fin`) to the verb it is an argument of. To achieve this binding, a proposition relation is assigned as the value of the verb’s `ARG2`, and this proposition in turn has an `ARG0`,

<sup>2</sup>In fact, for modifiers and specifiers we define lexical RMRSs in a special way, in that we immediately bind the semantic argument. The motivation for this is that whenever one of the dependency relations `mo` or `spec` are encountered, no matter what their exact `Pred` value may be, the semantics contributed by the head of this dependency can be unambiguously related to the semantic head, and is thus recorded already at the “lexical” level.

<sup>3</sup>As explained below, the information about subcategorized arguments is reconstructed from the triples, in the predicate `arg(Fctor,N,Arg)`, where `N` encodes the argument position, and `Fctor` and `Arg` are indices of functor and argument, respectively.

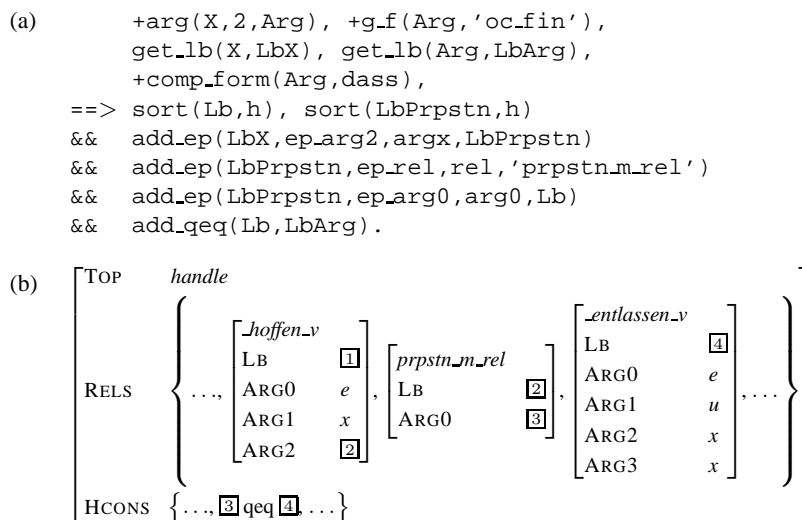

Figure 3: (a) Sample argument binding rule and (b) output RMRS.

which takes scope over the hook label of the matrix verb in the object clause (for the definition of the template `add_ep`, see Figure 2; the template `add_qeq` works similarly: It adds a `qeq` constraint to the set of handle constraints). In general, the binding of arguments does not depend on the order of rule applications. That is, the fact that the system performs concurrent rule applications in a cascaded rule set is not problematic for semantics construction. Though, we have to make sure that every partial structure is assigned a hook, prior to the application of composition rules. This is ensured by stating the rules for lexical RMRSs first.

**Scope constraints.** In having the rules introduce handle constraints, we define restrictions on the possible scoped readings. These are defined maximally restrictive in the sense that they must allow for all and only the admissible scopes. This is achieved by gradually adding `qeq` relations to the global `HCONS` set. Typically, this constraint relates a handle argument of a scopal element, e. g. a quantifier, and the label of the outscoped element. However, we cannot always fully predict the interaction among several scoping elements. This is the case, inter alia, for the modification of verbs by more than one scopal adverb. This type of ambiguity is modeled by means of a UDRT-style underspecification, that is, we leave the scope among the modifiers unspecified, but restrict each to outscope the verb handle.<sup>4</sup>

### 3.3 Challenges

Some aspects of semantic composition crucially depend on lexical and phrase structural information which is not available from the dependencies. Here we

<sup>4</sup>This is in accordance with the German HPSG grammar, and will also be adapted in the ERG (p.c. D. Flickinger).



briefly point out the problems and how we solved them.

**Argument Structure.** While LFG grammars explicitly encode argument structure in the semantic form of the predicate, the derived dependency triples only record the atomic PRED value. We recover the missing information by way of pre-processing rules. The rules make reference to the local grammatical functions of a predicate, and test for features typically borne by non-arguments, for instance, expletives can be identified via the feature `pron_type(.,expl)`. In the composition step, the resulting `arg` predicates will be interpreted as the *slots* that a functor needs to fill.

The TIGER-DB does not provide information about control properties of equiverbs, nor do they mark scopal modifiers. We extracted lexical entries from our broad-coverage German HPSG grammar, and interleave them with the rules for semantics construction, to ensure their proper representation.

**Constituency.** It is often assumed that there is a crucial difference between the semantics of VP-modification and that of S-modification. Thus, we are faced with the problem that no distinction whatsoever is drawn between heads and their projections in the dependency structures. Hence, we restrict scope with respect to the verb, but do not exclude the proposition-modifying reading.

Similarly, coordination is represented as a set of conjuncts in the triples, but to meet the binary branching coordination analysis of HPSG, we must construct a recursive semantic embedding of partial coordinations. The rules process the conjuncts in a right-to-left manner, each time combining the partial coordination to the right with the conjunct on the left, thereby building a left-branching coordination.

### 3.4 Treebank Construction and Quality Control

**TIGER 700 RMRS Treebank.** Our aim is to construct a treebank of 700 sentences from the TIGER dependency bank. Instead of selecting a random sample of sentences, we opt for a block of consecutive sentences. In this way, the treebank can be further extended by annotations for intersentential phenomena, such as co-reference relations, or discourse relations.

However, we have to accommodate for gaps, due to sentences for which there are reasonable syntactic, but (currently) no sound semantic analyses. This problem arises for sentences involving, e.g., elliptical constructions, or else ungrammatical or fragmented sentences. We include, but explicitly mark such sentences for which we can obtain partial, but no fully sound semantic analyses. We correspondingly extend the annotation set to yield a total of 700 correctly annotated sentences.

**Automatic Conversion and Quality Control.** For compilation of a manually controlled RMRS bank, we implemented a cascaded approach for quality control, with an initial feedback loop between (i) and (ii):

(i) Manual phenomenon-based error-detection. In the construction process, we mark the application of construction rules by inserting phenomenon-specific identifiers, and use these to select sample RMRSs for phenomenon-based inspection, both in the development phase and for final quality control.

(ii) Investigation of detected errors can result in the improvement of automatic RMRS construction (feedback loop to (i)). Errors that cannot be covered by general rules need to be adjusted manually.

(iii) Manual control. Finally, we perform manual control and correction of errors that could not be covered by automatic RMRS construction. In this phase, we mark and separate the structures or phenomena that are not covered by the state-of-the-art in RMRS-based semantic theory.

**Results.** The transfer grammar comprises 74 rewrite rules for converting dependency structures to RMRS, plus 34 macros and templates.

In a first validation experiment on the basis of 100 structures, we classified 20% of the RMRSs as involving errors that can be captured by adjustments of the automatic conversion rules (see step (ii) above), while 59% were fully correct.

After improvement of the rules we evaluated the quality of the automatic construction procedure by validating the 700 sentences of the treebank. Of the 700 structures, 4% contained phenomena which we do not analyse at all. 40% required no correction at all. For the 59% that needed manual correction, the average count of units to be corrected per sentence was 3.75. The number of RMRSs that needed less than the average of corrections was 601, i.e. 85.86%.

## 4 Conclusion

We have presented a method for semantics construction which converts dependency structures to (R)MRSs as they are output by HPSG grammars. This approach allows cross-framework parser evaluation on a broad-coverage basis, and can be applied to existing dependency banks for English (e. g. King et al. (2003)). As shown by manual correction of the automatically constructed RMRS treebank, our semantics construction method yields high-quality results, and can be extended to a full parsing architecture. A more extensive description and evaluation of the present work can be found in Spreyer and Frank (2005).

## References

- Brants, S., Dipper, S., Hansen, S., Lezius, W. and Smith, G. 2002. The TIGER Treebank. In *Proceedings of the Workshop on Treebanks and Linguistic Theories*, Sozopol, Bulgaria.
- Carroll, J., Frank, A., Lin, D., Prescher, D. and Uszkoreit, H. (eds.). 2002. *Beyond PARSEVAL – Towards Improved Evaluation Measures for Parsing Systems*,

- Workshop Proceedings of the *Third International Conference on Language Resources and Evaluation*, LREC 2002 Conference, Las Palmas, Gran Canaria.
- Copestake, A., Lascarides, A. and Flickinger, D. 2001. An Algebra for Semantic Construction in Constraint-based Grammars. In *Proceedings of the ACL 2001*, Toulouse, France.
- Copestake, A. 2003. Report on the Design of RMRS. Technical Report D1.1a, University of Cambridge, University of Cambridge, UK., 23 pages.
- Copestake, A., Flickinger, D., Sag, I. and Pollard, C. 2005. Minimal Recursion Semantics, to appear.
- Crouch, R. 2005. Packed Rewriting for Mapping Semantics to KR. In *Proceedings of the Sixth International Workshop on Computational Semantics, IWCS-06*, Tilburg, The Netherlands.
- Crouch, R., Kaplan, R., King, T.H. and Riezler, S. 2002. A comparison of evaluation metrics for a broad coverage parser. In *Beyond PARSEVAL. Workshop at the LREC 2002 Conference*, Las Palmas.
- Dalrymple, M. (ed.). 1999. *Semantics and Syntax in Lexical Functional Grammar: The Resource Logic Approach*. MIT Press.
- Dyvik, H., Rosén, V. and Meurer, P. 2005. LFG, Minimal Recursion Semantics and Translation. In *Proceedings of the LFG 2005 Conference*, CSLI Publications, to appear.
- Forst, M. 2003. Treebank Conversion – Establishing a test suite for a broad-coverage LFG from the TIGER treebank. In *Proceedings of LINC'03*, Budapest, Hungary.
- Forst, M., Bertomeu, N., Crysmann, B., Fouvry, F., Hansen-Schirra, S. and Kordoni, V. 2004. Towards a Dependency-Based Gold Standard for German Parsers: The Tiger Dependency Bank. In S. Hansen-Schirra, S. Oepen and H. Uszkoreit (eds.), *Proceedings of LINC 2004*, Geneva, Switzerland.
- Kaplan, R.M., Riezler, S., King, T.H., Maxwell, J.T., Vasserman, A. and Crouch, R. 2004. Speed and Accuracy in Shallow and Deep Stochastic Parsing. In *Proceedings of HLT-NAACL'04*, Boston, MA.
- King, T.H., Crouch, R., Riezler, S., Dalrymple, M. and Kaplan, R. 2003. The PARC 700 Dependency Bank. In *Proceedings of LINC 2003*, Budapest.
- Spreyer, K. and Frank, A. 2005. The TIGER RMRS Bank: RMRS Construction from Dependencies. In F. Bond, S. Oepen and K. Paic (eds.), *Proceedings of LINC 2005*, pages 1–10, Jeju Island, Korea.

# Persian free relatives

Mehran A. Taghvaipour

University of Essex

Proceedings of the 12th International Conference on  
Head-Driven Phrase Structure Grammar

Department of Informatics, University of Lisbon

Stefan Müller (Editor)

2005

Stanford, CA: CSLI Publications

pages 364–374

Taghvaipour, Mehran A. 2005. Persian free relatives. In Stefan Müller (ed.), *Proceedings of the 12th International Conference on Head-Driven Phrase Structure Grammar, Department of Informatics, University of Lisbon*, 364–374. Stanford, CA: CSLI Publications. DOI: 10.21248/hpsg.2005.21.



## Abstract

Free relatives (FRs) in Persian are Unbounded Dependency Constructions, containing gaps or resumptive pronouns (RPs). In some positions only gaps are allowed, and in some other positions only RPs. The structure of Persian FRs is bipartite, containing two constituents: a phrasal part and a sentential. Persian FRs are sensitive to the matching effect and show distinct properties from noun phrases, ordinary relative clauses, and interrogative complements. This paper proposes a unified HPSG account which assumes that the phrasal part of a FR is the head and the filler at the same time. The propped approach is presented in two versions (with and without traces) and can take care of the dependency between the gap or the RP and the licencing constituent with a truly single mechanism.

### 1. Introduction

Example (1) shows a Persian FR in brackets.

- (1)  
Yasmin            [hærči            Amy    \_\_\_\_ xærideh.bud]    ra<sup>1</sup>    bærdašt.  
Yasmin            whatever           Amy    \_\_\_\_ had.bought       RA    took-3sg  
'Yasmin took whatever Amy had bought.'

The structure of Persian FRs is bipartite, containing a phrasal part and a sentential part. The phrasal part always contains a word which has the prefix *hær-*, '-ever'. The sentential part is an incomplete finite sentence that contains either a gap or a RP. In subject and direct object positions only gaps are allowed; whereas, in object of preposition and genitive positions only RPs. Unlike ordinary relative clauses, FRs in Persian do not have any complementary position where both gaps and RPs are allowed. Persian data show that FRs in this language are sensitive to the 'matching effect'. Additionally, they allow 'pied piping', and the complementizer *ke*, which is obligatory in ordinary RCs, is optional in FRs.

### 2. The Analysis

I will use – among other things- three nonlocal features to capture the properties of FRs in Persian. One of these nonlocal features is the SLASH feature that will take care of the dependency between the gap or the RP and the FR phrase. The second is the GAPTYPE feature that handles the pattern of distribution of gaps and RPs. The third is the F-REL feature which is used to achieve two goals: (i) to distinguish words which can occur in FR constructions, and (ii) to determine the semantic content of the entire FR clause (Kim (2001)).

---

<sup>1</sup> This particle (whose colloquial form is *ro* or simply *-o*) is referred to as a specificity marker (Karimi, 1989). It comes after an NP when the NP is specific and is not in the position of subject or object of preposition.

A variety of evidence from coordination, parasitic gaps, crossover, and island constraints shows that Persian gaps and RPs are strikingly similar (See Taghvaipour (2005: 49)). To capture the similarities of RPs and gaps, I shall propose two possible approaches: one with traces and one without.

In the trace approach, gaps are treated as traces (as in Pollard and Sag's (1994), Levine and Hukari (2003), and Lee (2004)). In this approach, RPs are similar to traces except in two respects. Firstly, RPs will have phonological content whereas traces will not. Secondly, the value of their GAPTYPE features is different. GAPTYPE is a non-local feature whose value can be either *trace* or *rp*, for traces and RPs, respectively. The reason for distinguishing traces and RPs with a NONLOCAL feature is that this is not reflected within the value of SLASH and hence it is possible for a single unbounded dependency to be associated with a trace and an RP. This makes the inheritance of the nonlocal feature easy and possible in the middle of those UDCs which involve coordination of two NPs where one contains a RP and the other a gap. Other analyses (e.g., Vaillette (2001)) which utilise more than one nonlocal feature (SLASH and RESUMP) do not seem to be able to handle the inheritance of the features in such coordinate structures that contain gap in one conjunct and RP in the other. I propose the following lexical entry for trace.

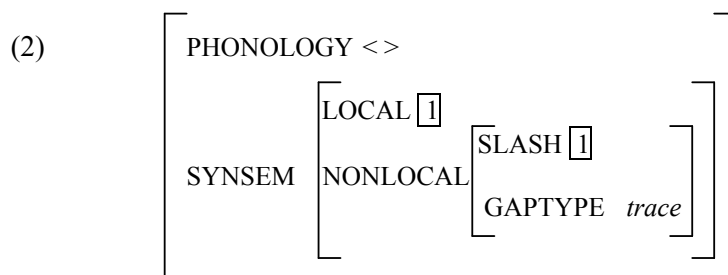

However, because RPs are not allowed in object positions in FRs, we require a more complex value for SLASH to encode the information we require to show what type of unbounded dependency (e.g., *wh*-interrogative, relative clause, free relative, etc.) the gap or the RP is used in. In this way, the encoded information is accessible not only at the bottom of the dependency but also at the top.

Similar to Przepiorkowski's (1999) assumption for the value of argument structure and valence features, I will assume that the value of SLASH is a set of *ud-object* elements, for which two features are appropriate: LOCAL and UD-TYPE. The value of LOCAL is a set of *local* structures, and the value of UD-TYPE is *ud-type*, which can be for instance *rc* (for relative clauses), *fr* (for free relatives), or *wh* (for *wh*-interrogatives). I assume that the value of SLASH is complex, as given in (3). The hierarchy in (4) shows three of the possible instances of *ud-type*.

(3) SLASH {  $\left[ \begin{array}{ll} ud-object & \\ LOCAL & local \\ UD-TYPE & ud-type \end{array} \right]$  }

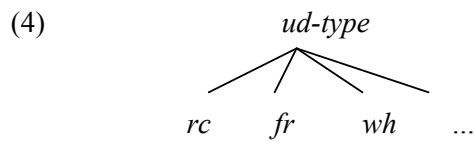

Thus, the nonempty SLASH feature in the sentential part of the FR encodes the information that there is a dependency between the trace/RP and the FR phrase, which can be of any arbitrary distance from the trace/RP.

I will propose the lexical entry in (5) for RPs and the one in (6) for traces. These lexical entries are the same except in two respects. Firstly, the value of the PHON feature in traces is an empty set; whereas in RPs, it is not empty. This means that RPs as overt elements have phonology but traces do not. The second difference between these two lexical entries is that the value of their GAPTYPE feature is different.

As I noted earlier, GAPTYPE is a feature that I have introduced to capture the distributional properties of RPs and traces. GAPTYPE is a non-local feature whose value can be either *trace* or *rp*. This treatment differentiates the *synsem* values of traces and RPs and allows me to subject them to different constraints, while the distinction is not reflected within the value of SLASH; and hence, it is possible for a single unbounded dependency to be associated with a trace and an RP.

(5) A resumptive pronoun

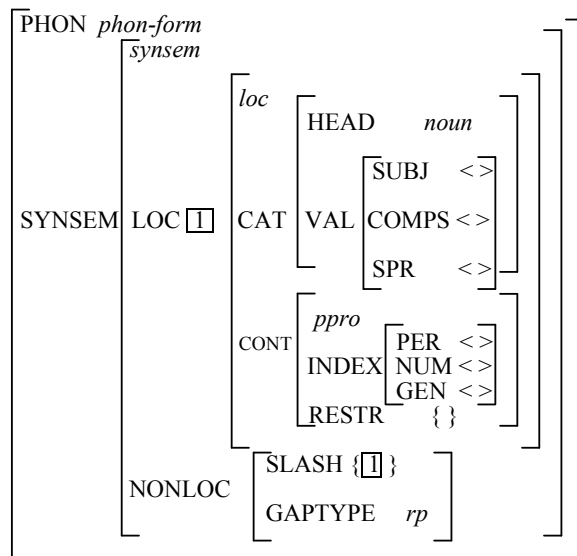

(6) A trace in a nominal position

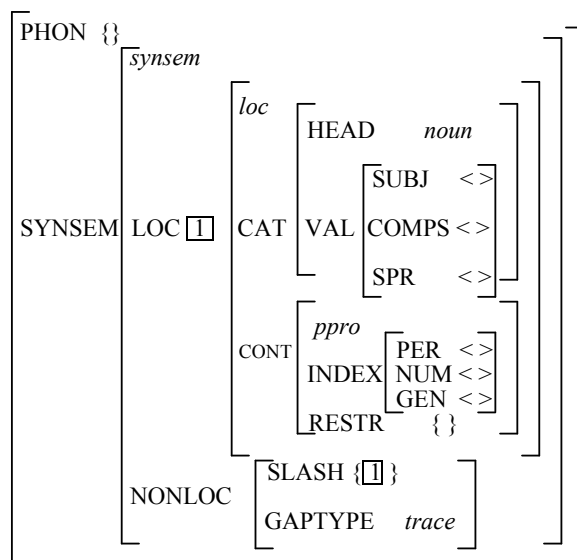

I noted earlier that RPs are not allowed in subject or direct object positions, while traces are not allowed in the positions of genitive or object of preposition. The constraint in (7) is to take care of RPs in subject position. The effect of this constraint is that if an element is a resumptive pronoun, then it cannot come in subject position.



(7) RESUMPTIVE SUBJECT CONSTRAINT

$$[\text{SUBJ } \langle \boxed{1} \rangle] \rightarrow \sim (\boxed{1} = [\text{SYNSEM}| \text{NONLOC}| \text{GAPTYPE } rp ])$$

To prevent traces from appearing in the positions of object of preposition and possessor, I propose the RESUMPTIVE NON-VERB CONSTRAINT in (8). According to this constraint, if there is a nominal trace in the complement of a verb, then that head has to be a verb. Thus, in the case of object of preposition and genitive cases (possessors), we will not have a trace because the head is not a verb.

(8) RESUMPTIVE NON-VERB CONSTRAINT

$$\left[ \begin{array}{l} \text{HEAD } \boxed{1} \\ \text{COMPS } \langle \dots, \left[ \begin{array}{l} \text{HEAD } \textit{noun} \\ \text{GAPTYPE } \textit{trace} \end{array} \right], \dots \rangle \end{array} \right] \rightarrow \boxed{1} = \textit{verb}$$

Finally, to prevent resumptive pronouns from appearing in direct object positions in Persian FRs, I propose the constraint in (9).

(9) RESUMPTIVE OBJECT CONSTRAINT

$$\left[ \begin{array}{l} \text{HEAD } \textit{verb} \\ \text{COMPS } \langle \dots, \left[ \begin{array}{l} \text{GAPTYPE } \textit{rp} \\ \text{SLASH } \{ [\text{UD-TYPE } \boxed{1}] \} \end{array} \right], \dots \rangle \end{array} \right] \rightarrow \sim \boxed{1} = \textit{fr}$$

The effect of this constraint is that if a complement of a verb is a RP, then the UD-TYPE value of that pronoun cannot be *fr*. In other words, a pronoun which is resumptive by having a *rp* value for its GAPTYPE feature and is used as a complement of a verb cannot be used in unbounded dependencies of the type free relative (*fr*).

Where there are some analyses (e.g., Pollard and Sag (1994: ch.1-8), Hukari and Levine (2003), and Sun-hee (2004)) that favour traces, there are also some analyses (e.g., Pollard and Sag (1994: ch.9), Sag and Fodor (1994), Sag (1997), Ginzburg and Sag (2000), and Bouma et al (2001)) that favour a traceless approach. In such approaches, there is a mechanism that makes a non-empty SLASH value appear at the bottom of dependency.

In earlier HPSG works (e.g., Pollard and Sag (1994), Sag and Fodor (1994) and Sag (1997)), this mechanism is in the form of a lexical rule (e.g. CELR) whose outputs stipulate a non-empty SLASH value. But as noted by Bouma et al. (2001), lexical rules are not desirable for two reasons: (i) they are meant to account for processes that are morphological in nature, and (ii) their formal status is a matter of debate.

In more recent analyses, (e.g., Ginzburg and Sag (2000) and Bouma et al (2001)), traceless accounts for filler-gap dependencies are provided without lexical rules. Bouma et al, following Sag (1997), assume the hierarchy in (10) for *synsem*.

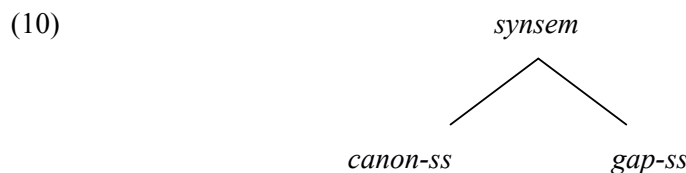

According to this hierarchy, gaps have *synsem* of type *gap-ss*, which obey the constraint in (11). According to this constraint, the LOCAL value of a *gap-ss* element corresponds to its SLASH value.

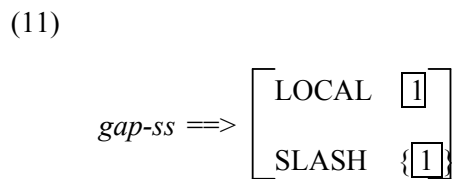

To provide a traceless approach to the bottom of dependency, I shall assume the hierarchy in (12) for *synsem*. This hierarchy treats *synsems* of RPs to be of type *rp-ss*, a mixed category: a subtype of *gap-ss* and *canon-ss* at the same time. As a result of being a subtype of *gap-ss*, the LOCAL value of a *rp-ss* element corresponds to its SLASH value (by virtue of Sag's (1997) constraint on *gap-ss*). Moreover, as *rp-ss* is a subtype of *canon-ss*; by virtue of the Principle of Canonality, RPs are overt linguistic expressions.

(12)

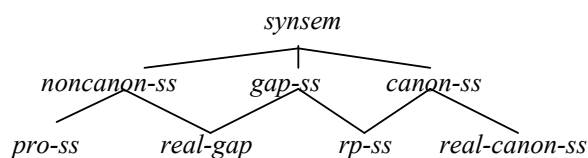

Ginzburg and Sag's (2000) Argument Realization Principle with a little modification (replacing *gap-ss* with *real-gap-ss*) works here as well. The principle can take care of RPs that are present on both ARG-ST list and COMP list, and gaps that may be present in the ARG-ST list but absent from the COMP list.

All we need now is to impose various constraints on RPs (whose *synsem* is of the type *rp-ss*) to look after their pattern of distribution of gaps and RPs. The constraints in (13) to (15) do the jobs of the constraints in (7) to (9) above.

(13) RESUMPTIVE SUBJECT CONSTRAINT (TRACELESS)

$$[\text{SUBJ } \langle \boxed{1} \rangle] \rightarrow \sim \boxed{1} = rp-ss$$

(14) RESUMPTIVE NON-VERB CONSTRAINT (TRACELESS)

$$\left[ \begin{array}{l} \text{HEAD } \boxed{1} \\ \text{ARG-ST } \langle [ ], \dots, \left[ \begin{array}{l} \text{real-gap-ss} \\ \text{HEAD } \textit{noun} \end{array} \right], \dots \rangle \end{array} \right] \rightarrow \boxed{1} = \textit{verb}$$

(15) RESUMPTIVE OBJECT CONSTRAINT (TRACELESS)

$$\left[ \begin{array}{l} \text{HEAD } \textit{verb} \\ \text{COMPS } \langle \dots, \left[ \begin{array}{l} \text{rp-ss} \\ \text{SLASH } \{ [\text{UD-TYPE } \boxed{1}] \} \end{array} \right], \dots \rangle \end{array} \right] \rightarrow \sim \boxed{1} = \textit{fr}$$

In the middle of dependency, I do not propose anything new. I will follow Sag (1997) but use Generalised Head Feature Principle of Ginzburg and Sag's (2000).

At the top of the dependency, the SLASH feature needs to be bound off at an appropriate point. Similar to Wright and Kathol's (2003) analysis, I assume that this appropriate point is the relative phrase which acts as the filler. However, if the relative phrase is the filler, then naturally, we expect to have the sentential part as the head, as shown by a thicker line in (16).

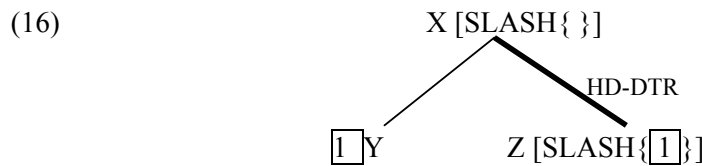

Persian data do not support this idea and suggest that it is the relative phrase that acts as the head in determining the external distribution of the phrase. For example, categorical matching comes from the relative phrase. Thus, I assume that the relative phrase in a Persian FR is the head and the filler at the same time. I will propose the structure in (17) for Persian FRs in which the filler is the head daughter.

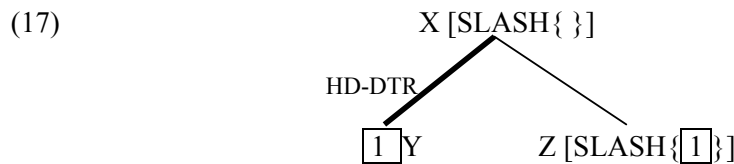

In both (16) and (17) above, we require the mother, (i.e., X) to be slash empty. Standard HPSG constraints that operate on headed phrases will suffice for (16) and will make sure that the filler combines with the head so that the mother phrase is an empty slash phrase. However, for (17) we will need more constraints which can operate on non-heads. I will therefore propose the constraint in (18) on Persian FRs.

(18)

$$\text{free-relative} \rightarrow \left[ \begin{array}{l} \text{SLASH } \{ \} \\ \text{DTRS} < [1] \left[ \begin{array}{l} \text{F-REL } \{ [ ] \} \\ \text{LOC} [2] \end{array} \right] \left[ \begin{array}{l} \textit{phrase} \\ \text{HEAD } \textit{verbal} \\ \text{SLASH } \{ [\text{LOC} [2]] \} \end{array} \right] > \\ \text{HD - DTR} [1] \end{array} \right]$$

There are two points noteworthy in this constraint. Firstly, the filler is the head daughter in this constraint for the reasons discussed in the previous paragraph. Secondly, the value of HEAD is *verbal*, not *v*. Following Sag (1997), I assume that *verbal* is a supertype of both verb (*v*) and complementizers (*c*). This assumption will allow us to handle the optionality of complementizer *ke* in Persian FRs.

There is also another nonlocal feature which originates at the relative phrase: the F-REL feature. We noted earlier that all Persian FRs start with the prefix *hær-*, ‘-ever’. This prefix is followed by either a *wh*-word, like *čī* (what), *ki* (who), and *koja* (where), or a noun like *kæs*, ‘person’, *ja*, ‘place’, and *væqt*, ‘time’. Of course, not all Persian *wh*-words are eligible to occur as fillers in FR constructions, neither are all *hær* elements allowed to come in Persian FRs.

To differentiate phrases that are eligible to occur as fillers in the FRs, I will use, following Kim’s (2001), the nonlocal feature F-REL which takes a set of referential indices as its value (Jacobson (1976), Kim and Park (1996) as cited in Kim (2001: 42)). FR words will have a nonempty specification for this feature. Other instances of *hær*- combinations or *wh*-words in any context other than the FR will have empty F-REL features.

Following Wright and Kathol (2003), I also assume that relative phrases need to be distinguished semantically as well. Therefore, I will assume that it is the value of the filler’s F-REL feature that determines the content of the entire FR clause. This feature is assumed to be projected from the relative word in the same manner that the SLASH feature is projected from the incomplete sentential part of the FR.

Following Kim (2001: 43), I will assume that the F-REL generated from a lexical entry is subject to the lexical amalgamation constraint as given in (19).

(19) Lexical Amalgamation of F-REL

$$\text{word} \implies \left[ \begin{array}{l} \text{ARG-ST} < [\text{F-REL } \boxed{1}], \dots, [\text{F-REL } \boxed{n}] > \\ \text{F-REL } \boxed{1} + , \dots, + \boxed{n} \end{array} \right]$$

This constraint ensures that if any element of a lexical head has a F-REL value, the lexical head itself also has the same F-REL value. This lexical amalgamation constraint combined with the Generalized Head Feature Principle of Ginzburg and Sag (2000), will take care of the inheritance of the F-REL value. Thus, the Lexical Amalgamation of F-REL prompts the lexical head to bear the feature F-REL, and the GHFP ensures that this value is identical between the head daughter and the head.

### References

- Bouma, G., R. Malouf, and I. Sag, 2001. Satisfying Constraints on Extraction and Adjunction. *Natural Language and Linguistic Theory* 19:1-65.
- Ginzburg J. and I. Sag, 2000. *Interrogative Investigations: The Form, Meaning, and Use of English Interrogatives*. CSLI Publications, Stanford, California.
- Kubota, Y. 2003. Yet Another HPSG-Analysis for Free Relative Clauses in German. In *The Proceedings of the 9<sup>th</sup> International Conference on HPSG*. Stanford University. USA.
- Kim. J.B. 2001. Constructional Constraints in English Free Relative constructions. *Korean Society for Language and Information* 5(1): 35-53.
- Lee, S-H. (2004) *A Lexical Analysis of Select Korean Unbounded Dependency Constructions*. Doctoral dissertation in Ohio State University, USA.
- Levine, R. D. and T. Hukari. 2003. *The Unity of Unbounded Dependency Constructions*. University of Chicago Press. USA.
- Pollard C., and I. Sag, 1994. *Head-Driven Phrase Structure Grammar*. The University of Chicago Press, USA.
- Przepiokowski, A. 1998. Case Assignment and the Complement-Adjunct Dichotomy: A Non-Configurational Constraint-Based Approach, Doctoral dissertation, University of Tübingen, Germany.
- Sag, Ivan. 1997. English Relative Clause Constructions. *Journal of Linguistics* 33: 431-484.
- Taghvaipour, M. 2005. *Persian Relative Clauses in Head-driven Structure Grammar*. PhD Dissertation. University of Essex. UK.
- Vaillette, N., 2001. Hebrew Relative Clauses in HPSG. *Proceedings of the 7th International Conference on Head-Driven Phrase Structure Grammar*, CSLI Publications.
- Wright, A. and A. Kathol. 2003. When a Head is not a Head: A Constructional Approach to Exocentricity in English. In Jong-Bok Kim and Steve Wechsler (eds.) *Proceedings of the Ninth International Conference on Head-Driven Phrase Structure Grammar*. Pages: 370-387.

# Plural comitative constructions in Polish

Beata Trawinski 

University of Tübingen

Proceedings of the 12th International Conference on  
Head-Driven Phrase Structure Grammar

Department of Informatics, University of Lisbon

Stefan Müller (Editor)

2005

Stanford, CA: CSLI Publications

pages 375–395

Trawinski, Beata. 2005. Plural comitative constructions in Polish. In Stefan Müller (ed.), *Proceedings of the 12th International Conference on Head-Driven Phrase Structure Grammar, Department of Informatics, University of Lisbon*, 375–395. Stanford, CA: CSLI Publications. DOI: 10.21248/hpsg.2005.22. 

## Abstract

This paper provides a treatment of Polish Plural Comitative Constructions in the paradigm of HPSG in the tradition of Pollard and Sag (1994). Plural Comitative Constructions (PCCs) have previously been treated in terms of coordination, complementation and adjunction. The objective of this paper is to show that PCCs are neither instances of typical coordinate structures nor of typical complement or adjunct structures. It thus appears difficult to properly describe them by means of the standard principles of syntax and semantics. The analysis proposed in this paper accounts for the syntactic and semantic properties of PCCs in Polish by assuming an adjunction-based syntactic structure for PCCs, and by treating the indexical information provided by PCCs not as subject to any inheritance or composition, but as a result of applying a set of principles on number, gender and person resolution that also hold for ordinary coordinate structures.

## 1 Introduction

In Polish, there are several types of Comitative Constructions (CCs), i.e., expressions that, generally speaking, (i) involve a PP headed by the preposition *z* ‘with’ and (ii) denote a relation between two (sets of) individuals / objects such that either (iia) one accompanies the other in an action / event / situation denoted by the predicate or (iib) they are both members of a set of equal participants involved in an action / event / situation denoted by the predicate. (1)–(5) provide examples of CC types that appear in Polish.

- (1) Jan z Marią wyjechał.  
Jan.NOM.SG with Maria.INSTR.SG left.SG  
‘Jan left with Maria.’
- (2) Jan wyjechał z Marią.  
Jan.NOM.SG left.SG with Maria.INSTR.SG  
‘Jan left with Maria.’
- (3) Jan z Marią wyjechali.  
Jan.NOM.SG with Maria.INSTR.SG left.PL  
‘Jan and Maria left.’
- (4) My z Marią wyjechaliśmy.  
we with Maria.INSTR.SG left.PL  
T1: ‘We left with Maria.’  
T2: ‘Maria and I left.’  
T3: ‘Maria and the rest of us left.’

---

<sup>†</sup>I would like to thank Stefan Dylą, Anna Feldman, Anna Kupść, Adam Przepiórkowski, Frank Richter and Manfred Sailer for very helpful discussions. I also appreciate the numerous comments made by the reviewers and audience at the 12th International Conference on Head-Driven Phrase Structure Grammar. I am grateful to Janah Putnam for her help in proofreading this paper.



- (5) *pro* *Z* *Maria* *wyjechaliśmy.*  
*pro* with *Maria*.INSTR.SG left.PL  
 T1: ‘We left with Maria.’  
 T2: ‘Maria and I left.’  
 T3: ‘Maria and the rest of us left.’

In the CC in (1), the preposition *z* ‘with’ takes the instrumental NP *Maria* ‘Maria’ and combines with the nominative NP *Jan* ‘Jan’. This sentence involves number, gender and person agreement between the nominative NP and the predicate. The interpretation of the CC in (1) is strictly comitative, i.e., the individual denoted by the NP selected by the preposition is interpreted as the comiter of the individual denoted by the NP modified by the *z*-PP (interpreted as the comitant).

The *z*-PP in strict CCs does not have to appear adjacent to the NP denoting the comitant. (2) exemplifies a CC in which the *z*-PP appears separated from the nominative NP, and is combined with the VP. This CC, however, has exactly the same interpretation as the CC in (1).<sup>1</sup>

Other types of CCs are constructions involving plural agreement on the verb. The first type consists of a singular NP and a *z*-PP and combines with plural predicates, as illustrated in (3). Note that, in contrast to the CCs in (1) and (2), the interpretation of the CC in (3) does not provide any comitative content in the proper sense. Both of the individuals denoted by the NP selected by the *z*-PP and the individual denoted by the NP combined with the *z*-PP, are involved in the event denoted by the predicate as equal participants. The comitant-comiter relationship is not accessible here.

The second type of CCs with plural agreement on the verb are expressions containing plural personal pronouns, as in (4). As indicated by the translations T1–T3, the sentence in (4) provides three possible interpretations. According to the first interpretation (see the translation T1), the first person plural pronoun *my* ‘we’ denotes a set of individuals including the speaker but not including the individual denoted by the NP selected by the preposition *z*, that is, *Maria*. In contrast, the meaning of the pronoun *my* ‘we’, according to the interpretation indicated by the translation T2, includes both the denotation of *Maria* and the speaker. It does not include any further individuals, and thus carries the meaning *Maria and I*. Finally, the pronoun *my* ‘we’ according to the third interpretation (see the translation T3) refers to a set of individuals including the speaker, the individual denoted by the argument of the preposition *z* ‘with’, i.e., *Maria*, as well as some further individuals. Note that the second and third person plural pronouns display the same ambiguity when used in CCs, such as in (4).<sup>2</sup>

<sup>1</sup>For a discussion on CCs of the types in (1) and (2), see McNally (1993), Vassilieva and Larson (2001), Feldman (2002), Ionin and Matushansky (2002) and Dylą and Feldman (to appear) for Russian, Comacho (1994) for Spanish and Dylą (1988) for Polish data.

<sup>2</sup>See Ladusaw (1989), Progovac (1997), Vassilieva and Larson (2001), Feldman (2002) and Ionin and Matushansky (2002) for a disquisition on Russian plural pronoun CCs, den Dikken et al. (2001) for a discussion on Hungarian data, Dylą (1988) for Polish, Aissen (1989) for Tzotzil, and Schwartz

Finally, comitative constructions such as (5), often referred to in the linguistic literature as verb-coded coordination (cf. Schwartz (1988) and Camacho (1994)) are possible in Polish. As in the case of plural pronoun CCs (cf. (4)), this kind of CC provides three interpretations relating to the denotation of *pro*. As reflected in the translations T1–T3 in (5), *pro* can be interpreted in three different ways, analogously with plural pronouns.<sup>3</sup>

This paper focuses exclusively on CCs of the type exemplified in (3) and leaves detailed investigations of remaining CCs for future work. Because of the plural agreement on the predicate, and in interest of being consistent with previous approaches, CCs such as in (3) will be referred to throughout this paper as Plural Comitative Constructions (PCCs).

PCCs have previously been treated by linguists in terms of coordination, complementation and adjunction. Most of these analyses, however, remain problematic in some respects. The objective of this paper is to show that PCCs are neither instances of typical coordinate structures, nor instances of typical complement or adjunct structures. It thus appears difficult to properly describe them by means of the standard principles on syntax and semantics.

The analysis proposed in this paper accounts for the syntactic and semantic properties of PCCs by (i) assuming an adjunction-based syntactic structure for PCCs, (ii) describing idiosyncratic properties of PCCs, such as the symmetry of both NPs, and ensuring a uniform theta-role assignment to these NPs by the lexical entry of the preposition *z* ‘with’, and (iii) licensing number, gender and person resolution by particular principles that construct the indexical information provided by entire PCCs. The principles of number, gender and person resolution also apply to ordinary coordinate structures in Polish.

## 2 Crucial Properties of PCCs

The following section characterizes PCCs with respect to number, gender and person resolution, as well as their behaviour with respect to coreference. All properties described in this section in the context of PCCs also apply to Polish coordination.

### 2.1 Number Resolution

As has already been mentioned in the Introduction, PCCs, although they contain only singular NPs, involve plural agreement on the predicate (cf. (3) restated here as (6)).

---

(1988) for an examination of plural pronoun CCs based on data from Yapese, Hungarian, Polish and Bulgarian.

<sup>3</sup>Verb-coded coordination has previously been discussed in Comacho (1994) and Comacho (2000) for Spanish, in Aissen (1989) for Tzotzil and in Schwartz (1988) for Dakota, Yapese, Kanuri, Bulgarian, Hungarian, Polish, Hausa and Chilean Spanish.

- (6) Jan z Marią wyjechali.  
 Jan.NOM.SG with Maria.INSTR.SG left.PL  
 ‘Jan and Maria left.’

The examples below show that PCCs can also act as controllers of plural relative pronouns (cf. (7)) and can be modified by plural attributive adjectives (cf. (8)).

- (7) Piotr zobaczył Jana z Marią, którzy właśnie przyszli.  
 Piotr saw Jan.SG with Maria.SG who.PL just arrived  
 ‘Piotr saw Jan and Maria, who had just arrived.’
- (8) Jan z Marią, zaproszeni przez Piotra, przyszli punktualnie.  
 Jan.SG with Maria.SG invited.PL by Piotr arrived on time  
 ‘Jan and Maria, invited by Piotr, arrived on time.’

The examples in (6)–(8) indicate that the NP *z* NP cluster bears a plural valued number category.

## 2.2 Gender Resolution

The next interesting observation can be made with respect to gender resolution. As one can see in (9), whenever a PCC involves a masculine-human (M1) NP, regardless of whether it is a nominative or an instrumental NP, the gender value of the predicate is also masculine-human.<sup>4</sup>

- |     |   |   |   |  |   |                                     |
|-----|---|---|---|--|---|-------------------------------------|
| (9) | } | Ojciec z synem<br>father.M1 with son.M1<br>‘The father and the son’                   | } | Syn z ojcem<br>son.M1 with father.M1<br>‘The son and the father’                   | } | wrócili.<br>came back.M1<br>‘left.’ |
|     |   | Ojciec z psem<br>father.M1 with dog.M2<br>‘The father and the dog’                    |   | Pies z ojcem<br>dog.M2 with father.M1<br>‘The dog and the father’                  |   |                                     |
|     |   | Ojciec z oddziałem<br>father.M1 with department.M3<br>‘The father and the department’ |   | Oddział z ojcem<br>department.M3 with father.M1<br>‘The department and the father’ |   |                                     |
|     |   | Ojciec z matką<br>father.M1 with mother.FEM<br>‘The father and the mother’            |   | Matka z ojcem<br>mother.FEM with father.M1<br>‘The mother and the father’          |   |                                     |
|     |   | Ojciec z dzieckiem<br>father.M1 with child.NEUT<br>‘The father and the child’         |   | Dziecko z ojcem<br>child.NEUT with father.M1<br>‘The child and the father’         |   |                                     |

<sup>4</sup>According to the traditional approach to gender of Saloni and Świdziński (1998), based on Mańczak (1956), the gender system of contemporary Polish consists of five grammatical genders: *masculine-human* / (M1) or (VIRILE) (e.g., *chłopiec* ‘boy’), *masculine-animal* (M2) (e.g., *pies* ‘dog’), *masculine-inanimate* (M3) (e.g., *stół* ‘table’), *feminine* (FEM) (e.g., *dziewczyna* ‘girl’) and *neuter* (NEUT) (e.g., *okno* ‘window’). This approach has been adopted here.

The examples in (9) show that both NPs participate in gender resolution. Further evidence for the involvement in gender resolution of both NPs embedded in a PCC can also be provided by relative pronoun constructions and attributive modification. For lack of space, no examples will be provided here, however.<sup>5</sup>

### 2.3 Person Resolution

The involvement of both NPs can also be observed in person resolution, as the examples in (10) illustrate. If different persons are contained in a PCC, the first person has priority over the second and the second over the third. Thereby, the order of NPs bearing different person values does not affect person resolution.

- (10) a. To przecież właśnie ja z tobą, jako najwięksi aktywiści  
it though just I.1ST with you.2ND as best activists  
w naszym ugrupowaniu, zorganizowaliśmy ten protest.  
in our group organized.1ST this protest  
'It was just me and you, who, as the best activists in our group,  
organized this protest.'
- b. To przecież właśnie ja z nim, jako najwięksi aktywiści  
it though just I.1ST with him.3RD as best activists  
w naszym ugrupowaniu, zorganizowaliśmy ten protest.  
in our group organized.1ST this protest  
'It was just he and I, who, as the best activists in our group, orga-  
nized this protest.'
- c. To przecież właśnie ty z nim, jako najwięksi aktywiści  
it though just you.2ND with him.3RD as best activists  
w naszym ugrupowaniu, zorganizowaliście ten protest.  
in our group organized.2ND this protest  
'It was just he and you, who, as the best activists in our group,  
organized this protest.'

### 2.4 Coreference

Another observation that can be made relates to coreference phenomena. As illustrated in (11), only the entire NP z NP cluster can bind reflexive possessive pronouns and PRO subjects of infinitive and participial clauses.

- (11) a. [Jan<sub>i</sub> z Marią<sub>j</sub>]<sub>k</sub> odwiedzili swego<sub>\*i/\*j/k</sub> przyjaciela.  
Jan with Maria visited RFL.POSS.PRN friend  
'Jan and Maria visited their friend.'

<sup>5</sup>For a more detailed discussion on gender resolution in Polish and in other Slavonic languages see Corbett (1983). See also Dylą (2003) for a discussion on gender resolution in Polish plural pronoun CCs.

- b. [Jan<sub>i</sub> z Maria<sub>j</sub>]<sub>k</sub> chcieli PRO<sub>\*i/\*j/k</sub> wyjechać.  
 Jan with Maria wanted PRO leave  
 ‘Jan and Maria wanted to leave.’
- c. PRO<sub>\*i/\*j/k</sub> spakowawszy się, [Jan<sub>i</sub> z Maria<sub>j</sub>]<sub>k</sub> wyjechali.  
 PRO having packed Jan with Maria left  
 ‘Having packed, Jan and Maria left.’

## 2.5 Summary of Present Observations

Summing up the present observations, one can conclude that (i) the number value of the NP z NP cluster is plural, (ii) both NPs participate in gender resolution, (iii) both NPs participate in person resolution, (iv) the entire NP z NP cluster acts as a controller of possessive reflexive pronouns and PRO subjects.

It has been observed that with regard to these properties, PCCs behave as typical coordinate structures. As a result, several coordination-based approaches to PCCs have been developed. In the next section, the most significant of these will be presented.

## 3 Coordination-Based Approaches

This section discusses coordination-based approaches to PCCs, in which the analyses of Vassilieva and Larson (2001), Dylą (1988) and Dylą and Feldman (to appear) will be presented. The objective of this section is to briefly address the shortcomings of these particular analyses and to summarize arguments against the treatment of PCCs as coordinate structures.

### 3.1 Vassilieva and Larson (2001)

Vassilieva and Larson (2001) propose a syntactic structure for Russian PPCs that corresponds to a syntactic structure of ordinary coordination (cf. (1)). Here, both NPs (or rather DPs, according to Vassilieva and Larson (2001)) involved, and the preposition, all form separate constituents, as depicted below.

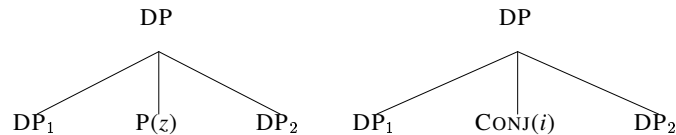

Figure 1: The structure of PPCs and coordinations according to Vassilieva and Larson (2001)

While this analysis might work for Russian, it does not apply to Polish PCCs. Firstly, it does not explain how the case assignment to the DP<sub>2</sub> works. Further, the inversion of DP<sub>1</sub> and DP<sub>2</sub>, which is possible in a typical coordination (cf. (12)),

cannot be ruled out and, consequently, the licensing of ungrammatical sentences such as that in (13b) cannot be prevented.<sup>6</sup>

- (12) a. Jan i Maria wyjechali.  
 Jan and Maria left  
 ‘Jan and Maria left.’  
 b. Maria i Jan wyjechali.  
 Maria and Jan left  
 ‘Maria and Jan left.’
- (13) a. Jan z Marią wyjechali.  
 Jan with Maria left  
 ‘Jan and Maria left.’  
 b. \*Marią z Jan wyjechali.  
 Maria.INST with Jan left

Finally, the analysis of Vassilieva and Larson (2001) does not account for grammatical structures such as that in (14), where in addition to the preposition *z* ‘with’, an alleged conjunction, the proper conjunction *i* ‘and’ is present.

- (14) Jan z Marią i z Anną wyjechali.  
 Jan with Maria and with Anna left  
 ‘Jan, Maria and Anna left.’

As the example in (15) illustrates, the coexistence of multiple conjunctions in parallel is ungrammatical in Polish.

- (15) Jan i Maria (\*oraz) i Anna wyjechali.  
 Jan and Maria and and Anna left  
 ‘Jan, Maria and Anna left.’

### 3.2 Dyła (1988) and Dyła and Feldman (to appear)

Dyła (1988) examines Polish PCCs and treats them as instances of conjunctionless binary coordination, as in Figure 2. The preposition *z* ‘with’ is analyzed as a clitic combining with an instrumental NP. The instrumental NP acts as the head of the *z* NP cluster.

<sup>6</sup>Note, however, that free reshuffling conjuncts occur only in multiple conjunct coordination. In binary coordination, the order of conjuncts is rigid (cf. (i) provided by Stefan Dyła, p.c.).

- (i) a. Zarówno Kwaśniewski jak i Belka spotkali się z Bushem.  
 both Kwaśniewski as and Belka met RM with Bush  
 ‘Both Kwaśniewski and Belka met Bush.’  
 b. \*Jak i Belka zarówno Kwaśniewski spotkali się z Bushem.  
 as and Belka both Kwaśniewski met RM with Bush  
 ‘Both Belka and Kwaśniewski met Bush.’ [intended]

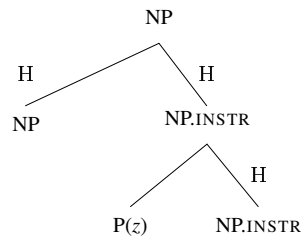

Figure 2: The structure of PCCs according to Dylą (1988)

A similar analysis has been proposed by Dylą and Feldman (to appear). It differs from that provided by Dylą (1988) only in that it assumes a different internal structure for the *z* NP cluster (cf. Figure 3). The *z* NP cluster is treated here as a PP headed by the preposition *z* ‘with’, analyzed as a weak head as understood by Abeillé (2003).

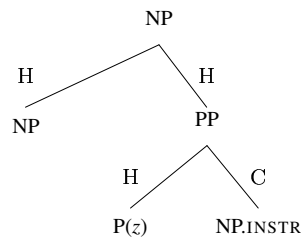

Figure 3: The structure of PCCs according to Dylą and Feldman (to appear)

As has been rightly observed by McNally (1993), treating PCCs as cases of coordinate structures fails to explain the difference in the distribution of possessive and reflexive possessive pronouns in ordinary coordinate structures and in PCCs (cf. (16)).<sup>7</sup>

- (16) a. Zarówno Jan<sub>i</sub> jak i jego<sub>i</sub> / \*swoja<sub>i</sub> żona wyjechali.  
 both Jan as and his / RFL.POSS.PRN wife left  
 ‘Both Jan and his wife left.’
- b. Jan<sub>i</sub> z(e) ?jego<sub>i</sub> / ?swoja<sub>i</sub> żoną wyjechali.  
 Jan with his / RFL.POSS.PRN wife left  
 ‘Jan left with his wife.’

While a clear contrast in the usage of possessive and reflexive possessive pronouns can be observed in coordination (cf. *jego* vs. *swoja* in (16a)), no such differ-

<sup>7</sup>Note, however, that the Russian data provided in McNally (1993) is, for lack of indices, not precise concerning the reference of pronouns. Despite what the examples in McNally (1993) seem to indicate, Russian non-reflexive possessive pronouns cannot be coreferent with first NPs. (I thank Anna Feldman, p.c., for pointing this out to me.)

ence can be found in PCCs.<sup>8</sup> Given this, it seems plausible to assume two different structures for ordinary coordination and PCCs.<sup>9</sup>

### 3.3 Further Arguments against Coordination-Based Analyses

The most critical point in analyzing PCCs as coordinate structures is the case assignment to the second NP, which is marked for instrumental. By definition, there are no instances of coordination in which there is case assignment.

A further unexpected property of the treatment of PCCs as coordination is the fact that PCCs, unlike ordinary coordination, do not allow categories other than nouns. While not only NPs but also VPs, APs and other kinds of phrases, as well as mixed categories, are possible in ordinary coordination, only NPs can be included in PCCs.

Further, PCCs allow for pro-drop, while ordinary coordination does not (cf. (17) vs. (18)).<sup>10</sup>

- (17) a. On i Maria poszli do kina.  
           he and Maria went to cinema  
           ‘He and Maria went to the cinema.’  
       b. \**pro* I Maria poszli do kina.  
           *pro* and Maria went to cinema

<sup>8</sup>According to Dyla (1988), the usage of both irreflexive possessive and reflexive possessive pronouns referring to first NPs in Polish PCCs is ungrammatical. However, the native speakers of Polish interviewed for the purpose of this paper judge sentences like (16b) to be somewhat unnatural but acceptable. But even though no possessive pronouns coindexed with the first NP were possible in PCCs, there would still be a contrast between ordinary coordination and PCCs with respect to the occurrence of ordinary possessive pronouns, as has been pointed out to me by Stefan Dyla, p.c.. While they are acceptable in the case of ordinary coordination, they are not within the PCC.

<sup>9</sup>Note that none of the previous binding theories for Polish seem to be able to account for data as in (16b) (cf. Reinders-Machowska (1991) or Marciniak (2001)), however, this paper is not an attempt to provide an appropriate theory. It should only be noticed here that the treatment of pronouns within PCCs does not require a separate binding theory, as a number of binding phenomena in Polish pose a challenge to the previous binding theories in the same respects as PCCs (cf. the sentences below).

- (i) Żaden autor<sub>i</sub> swoich<sub>i</sub> powieści nie ma do nich stosunku obiektywnego.  
       no author RFL.POSS.PRN novels not has to them relationship objective  
       ‘No author has an objective relationship with his own novels.’  
       (ii) Ta książka<sub>i</sub> o życiu jej<sub>i</sub> autora kosztuje 10 Euro.  
           this book about life its author costs 10 euros  
           ‘This book about the life of its author costs 10 euros.’

<sup>10</sup>Recall that sentences such as (18b) have three possible readings, as has been already indicated in the Introduction on the basis of the example in (5). In (18b), only that reading is considered which corresponds to the translation T2 in (5). The remaining two readings are ignored here. As Stefan Dyla, p.c., pointed out, both (18a) and (18b) are also ambiguous with respect to the interpretation of the NP *bratem* ‘brother’, which can involve either the speaker (cf. *my brother*) or the denotations of the pronouns *on* ‘he’ and *pro* respectively (cf. *his brother*).



- (18) a. On z bratem poszli do kina.  
He with brother went to cinema  
'He and his brother went to the cinema.'
- b. *pro* Z bratem poszli do kina.  
*pro* with brother went to cinema  
'He and his brother went to the cinema.'

And finally, PCCs behave differently from coordination with respect to Across-the-Board extraction. In a coordinate structure, the same constituent may be moved out of each conjunct.<sup>11</sup> This, however, seems not to be possible within PCCs (cf. the examples in (19a) and (19b) provided by Stefan Dyła, p.c.). The contrast between (19a) and (19b) seems to argue against a coordination-based analysis.

- (19) a. Czyim<sub>*i*</sub> dowodziłeś [t<sub>*i*</sub> ojcem] i [t<sub>*i*</sub> bratem]?  
whose commanded.2ND.SG *t* father and *t* brother  
'Whose father and brother was under your command?'
- b. \*/??Czyim<sub>*i*</sub> dowodziłeś [t<sub>*i*</sub> ojcem] z [t<sub>*i*</sub> bratem]?  
whose commanded.2ND.SG *t* father with *t* brother  
'Whose father and brother was under your command?' [intended]

### 3.4 Summary of Arguments against Coordination-Based Analyses

To sum up the arguments against the coordination-based treatment of PCCs, one can state that (i) PCCs involve internal case assignment, (ii) proper conjunctions can appear in PCCs, (iii) there is no contrast in the usage of possessive vs. reflexive possessive pronouns in PCCs, as is the case in ordinary coordination, (iv) the category of both phrases involved in PCCs is limited to nouns, (v) pro-drop is possible in PCCs, and finally, (vi) PCCs do not allow Across-the-Board extraction.

Recall, however, that PCCs behave as typical coordinate structures with regard to number, gender and person resolution, as well as with respect to coreference phenomena.

## 4 A Complementation-Based Approach

An interesting approach to Russian PCCs has been proposed by Feldman (2002). According to this proposal, the Russian *s* 'with' as used in PCCs, is a transitive noun, that selects for an instrumental NP and a subject NP. (cf. the structure of a sample PCC in Figure 4).<sup>12</sup>

The approach of Feldman (2002) correctly describes number resolution in PCCs, makes correct predictions about the distribution of reflexive possessive pronouns in

<sup>11</sup>See Ross (1967).

<sup>12</sup>The  $i + j$  description used as the INDEX value of the entire PCC has been taken from Feldman (2002). We assume that this specification simply acts as a new variable and that it has nothing to do with mathematical summation.

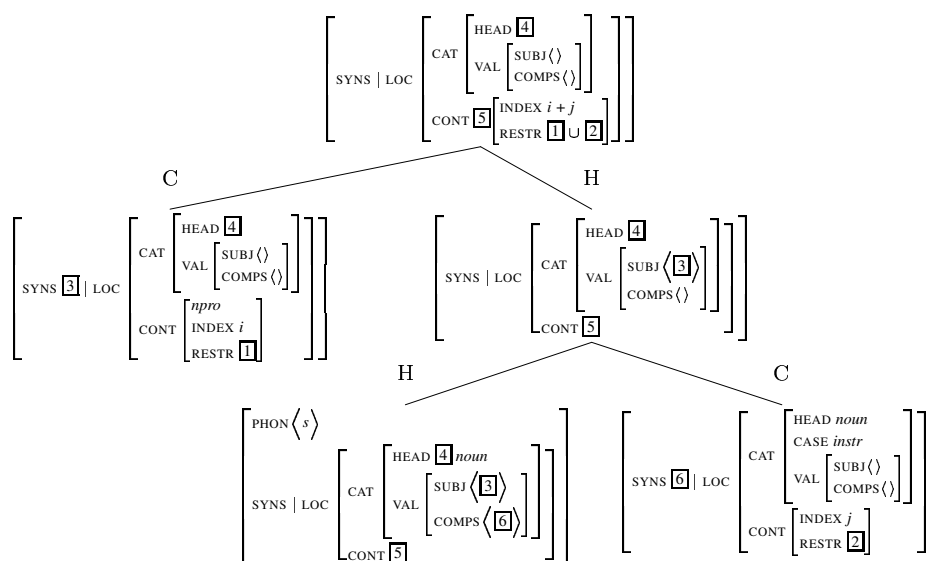

Figure 4: The structure of an exemplary PCC according to Feldman (2002)

Russian PCCs and ensures that the first NP always varies in case, while the second NP is always instrumental. However, by treating *s* ‘with’ as a noun, the modifiability of the *s* NP cluster by collectivizing adverbs such as *vmeste* ‘together’ cannot be explained, since adverbs are traditionally considered as not being able to modify nominal objects, only events / actions / situations, denoted by VPs and PPs. As in the approach of Feldman (2002), the *z* NP cluster is treated as a nominal object, no adverb modification can be licensed, at least, not without providing special lexical entries for collectivizing adverbs.

Also, the vocalic alternation of *s* ‘with’ (i.e., *s* vs. *so*) appears unexpectedly when considering it a noun, as proposed in Feldman (2002). Such an alternation is typical for prepositions and not for nouns.

## 5 Adjunction-Based Approaches

This section presents two adjunction-based approaches to PCCs: the approach of McNally (1993) and our own approach. For an adjunction-based transformational approach to PCCs and other types of comitative constructions in Russian, see also Ionin and Matushansky (2002).

### 5.1 McNally (1993)

McNally (1993) analyzes PCCs in terms of an NP adjunction (cf. the structure in Figure 5).

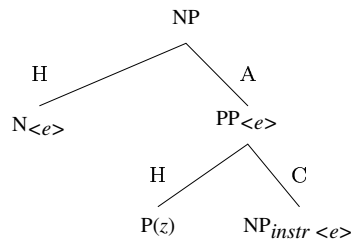

Figure 5: The structure of PCCs according to McNally (1993)

The adjunction-based analysis of McNally (1993) correctly predicts that (i) the category of phrases connected by the preposition *z* ‘with’ is nominal, (ii) the case of the first NP is assigned by the predicate, while the case of the second NP is assigned by the preposition *z* ‘with’, (iii) neither NP can be inverted, (iv) the *z* PP can be conjoined with another *z* PP by means of proper conjunctions, (v) no Across-the-Board extraction is possible.

McNally (1993) claims, however, that PCCs may involve only referential NPs, that is, NPs which have well-defined type  $\langle e \rangle$  denotations in addition to generalized quantifier-type denotations (type  $\langle \langle e, t \rangle, t \rangle$ ). While ordinary coordination can involve any combination of referential and non-referential NPs, PCCs involve only referential NPs.

To account for number resolution, McNally (1993) proposes that the *z*-PP denotes the same semantic type as the NP contained within it, that is, type  $\langle e \rangle$  in terms of Montague (1974). This fact, according to McNally (1993), would allow an operation which joins individuals of type  $\langle e \rangle$  to unite the entity denoted by the NP heading the PCC, with that denoted by the *z*-PP. The result would be a plural entity which could serve as an agreement controller.

To illustrate her claim, McNally (1993) provides, among others, the following Polish example involving non-referential NPs. Sie judges (20) to be ungrammatical.

- (20) \*Każdy chłopak *z* każdą dziewczyną odtańczyli polkę...  
 each boy.SG with each girl.INSTR.SG danced.PL polka

However, according to the judgments of native Polish speakers interviewed for the purpose of this paper, (20) is fully acceptable under the interpretation for the situation in which each boy danced the polka and each girl danced the polka (cf. the simplified formalization in (21)).

- (21)  $\forall x(\text{boy}(x) \rightarrow \mathbf{dance}'(x)) \wedge \forall y(\text{girl}(y) \rightarrow \mathbf{dance}'(y))$

Only the interpretation in which each boy-girl pair danced the polka (cf. the simplified formalization in (22)) seems to be excluded here.<sup>13</sup> Note, however, that some native speakers accept even this interpretation.

<sup>13</sup>The  $\oplus$  symbol stands for the sum formation in terms of Link (1991).

$$(22) \quad \forall x \forall y (boy(x) \wedge girl(y) \rightarrow \mathbf{dance}'(x \oplus y))$$

McNally (1993)'s claim that only referential NPs can be involved in PCCs seems thus too strong, at least for Polish.

Further evidence against treating the *z*-PP as an expression of type  $\langle e \rangle$  is the fact that the PP can be modified by the adverb *razem* 'together' and by other collectivizing adverbs, such as *wraz* 'together', *łącznie* 'jointly', *współ* 'jointly', *wspólnie* 'together / jointly', *włącznie* 'inclusive', etc., which usually combine with expressions of types higher than the type  $\langle e \rangle$  (e.g., VPs or PPs).

Finally, the approach of McNally (1993) does not account for gender and person resolution in PCCs.

## 5.2 Our Proposal

In the following, a treatment of PCCs will be proposed according to which PCCs are analyzed as instances of NP adjunction, as in McNally (1993)'s approach. However, in contrast to the approach of McNally (1993), the *z*-PP will be treated here as an ordinary PP of the semantic type  $\langle e \langle e, t \rangle \rangle$ . Number, as well as gender and person resolution are accounted for by virtue of particular principles that also apply to ordinary coordination.

In Figure 6, a lexical entry for the preposition *z* 'with' as it appears in PCCs is provided.

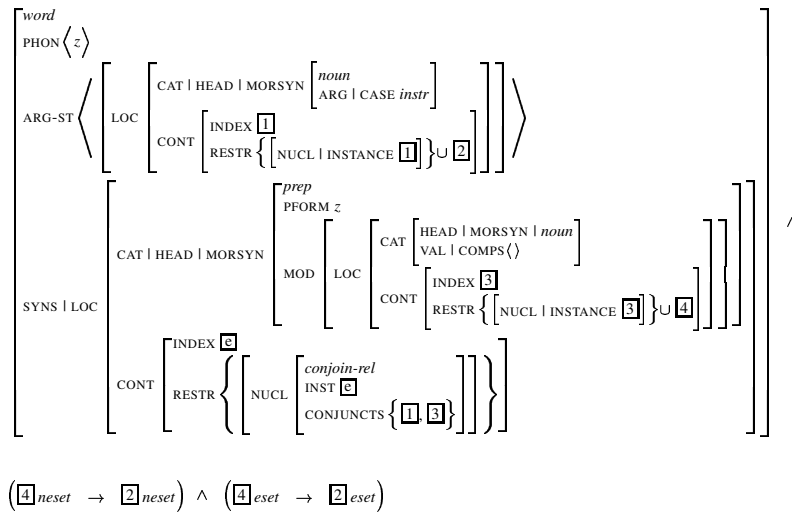

Figure 6: The lexical entry of the preposition *z* 'with'

Here, the approach to agreement proposed in Czuba and Przepiórkowski (1995) has been adopted, based on Kathol (1999)<sup>14</sup> and elaborated for Polish in Przepiórkowski et al. (2002). According to this approach, linguistic signs contain informa-

<sup>14</sup>See also Wechsler and Zlatić (2001) for a similar approach.

tion on their number, gender and, in the case of verbs, person at two representation levels, that is, at both the semantic and the morphosyntactic level. The semantic agreement features are provided, as in the traditional approach of Pollard and Sag (1994), by means of the value of the attribute INDEX via the following path: SYNSEM | LOCAL | CONTENT | INDEX, while the morphosyntactic agreement features are provided by the attribute AGR(EEMENT) via the following path: SYNSEM | CATEGORY | HEAD | MORSYN | AGR.

Further, a uniform feature geometry for all *content* objects has been assumed. The CONTENT value is, thus, the *content* object containing an index as well as the semantic restrictions of this index. The CONTENT value of the preposition *z* ‘with’ as appears in PCCs thus provides an event variable in terms of Davidson (1967) and a *conjoint-relation* for which the attribute CONJUNCTS is appropriate, taking a set of indices as its value.<sup>15</sup> This specification allows one to account for the distributive reading provided by PCCs.<sup>16</sup>

The lexical entry in Figure 6 also ensures that NPs involved in PCCs must have similar modification (see the tags [2] and [4]). As McNally (1993) and Dyla and Feldman (to appear) have observed that when NPs in PCCs combine with determiners or adjectives, each must occur with the same determiner or similar adjectives.

To account for number resolution, the principle in Figure 7 has been provided. This ensures that if in a head-adjunct-structure the adjunct-daughter is the preposition *z* ‘with’ providing the *conjoin-relation*, the number of the entire structure is plural. Note that the same holds for coordination.

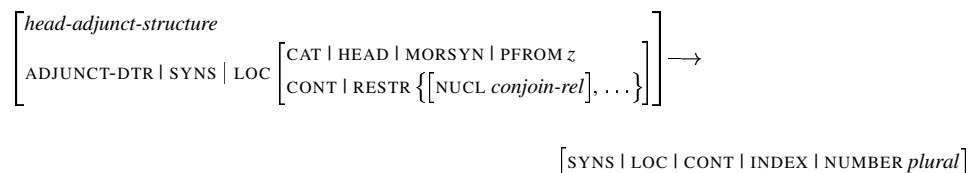

Figure 7: The principle of number resolution

To describe gender resolution in PCCs, the following rules for gender resolution, proposed by Corbett (1983), have been adopted: (i) if there is at least one masculine-human conjunct, the masculine-human form is used; (ii) if the con-

<sup>15</sup>Note that, given this, a slight modification of the hierarchy under the sort *index* must be undertaken.

<sup>16</sup>For lack of space, the behavior of PCCs with respect to the distributive versus collective reading will not be discussed here in detail. It should only be noted that, in contrast to McNally (1993)’s view, which assumes only collective readings of PCCs, Polish PCCs can be interpreted as having both distributive and collective denotations. In this respect, Polish PCCs show the same properties as Russian PCCs, discussed in Dalrymple et al. (1998). Dalrymple et al. (1998) claim, moreover, that there are no differences in the denotation of PCCs, simple plural NPs and coordinate structures. Detailed investigations on whether or not this claim can be applied to Polish plural expressions will be left, however, for future work.

For a discussion on the interpretation of Polish PCCs, see Dyla and Feldman (to appear).

juncts include the semantic features male and human, the masculine-human or non-masculine-human form is used; (iii) if there is at least one masculine-animate conjunct, the masculine-human or non-masculine-human form is used; (iv) otherwise the non-masculine-human form is used. Figure 8 presents the HPSG formalization of these rules.<sup>17</sup>

$$\begin{array}{c}
 \forall \boxed{1} \forall \boxed{3} \\
 \left[ \begin{array}{c}
 \text{head-adjunct-structure} \\
 \text{ADJUNCT-DTR} \left[ \begin{array}{c}
 \text{SYNS} \mid \text{LOC} \left[ \begin{array}{c}
 \text{CAT} \mid \text{HEAD} \mid \text{MORSYN} \mid \text{PFORM } z \\
 \text{CONT} \mid \text{RESTR} \left\{ \left\{ \text{NUCL} \mid \text{CONJUNCTS } \boxed{1}, \dots \right\} \right\} \\
 \text{CONX} \mid \text{BACKGROUND } \boxed{3}
 \end{array} \right]
 \end{array} \right]
 \end{array} \right] \rightarrow \\
 \left( \begin{array}{c}
 \left( \begin{array}{c}
 \left[ \text{SYNS} \mid \text{LOC} \mid \text{CONT} \mid \text{INDEX} \mid \text{GENDER } m1 \right] \\
 \wedge \exists \boxed{2} \left( \text{member}(\boxed{2}[\text{GENDER } m1], \boxed{1}) \right)
 \end{array} \right) \vee \\
 \left( \begin{array}{c}
 \left[ \text{SYNS} \mid \text{LOC} \mid \text{CONT} \mid \text{INDEX} \mid \text{GENDER } m1 \vee \text{non-}m1 \right] \\
 \wedge \exists \boxed{2} \left( \text{member}(\boxed{2}[\text{male}], \boxed{1}) \right) \wedge \exists \boxed{4} \left( \text{member}(\boxed{4}[\text{human}], \boxed{3}) \right)
 \end{array} \right) \vee \\
 \left( \begin{array}{c}
 \left[ \text{SYNS} \mid \text{LOC} \mid \text{CONT} \mid \text{INDEX} \mid \text{GENDER } m1 \vee \text{non-}m1 \right] \\
 \wedge \exists \boxed{2} \left( \text{member}(\boxed{2}[\text{GENDER } m2], \boxed{1}) \right)
 \end{array} \right) \vee \\
 \left( \begin{array}{c}
 \left[ \text{SYNS} \mid \text{LOC} \mid \text{CONT} \mid \text{INDEX} \mid \text{GENDER } \text{non-}m1 \right] \\
 \wedge \neg \exists \boxed{2} \left( \text{member}(\boxed{2}[\text{GENDER } m1 \vee m2], \boxed{1}) \right) \wedge \neg \exists \boxed{4} \left( \text{member}(\boxed{4}[\text{male}], \boxed{3}) \right)
 \end{array} \right)
 \end{array} \right)
 \end{array}
 \end{array}$$

Figure 8: The principle of gender resolution

The following rules for person resolution, adopted from Corbett (1983) and formalized in Figure 9, have been assumed: (i) if the conjuncts include a first person, first person agreement forms are used; (ii) if the conjuncts do not include a first person and include a second person, second person agreement forms are used, (iii) if the conjuncts include neither a first nor a second person, third person agreement forms are used.<sup>18</sup>

Finally, the principles in (23) and (24), adopted here from Sag et al. (2003) but adapted for our analysis, will ensure the correct percolation of semantic information along syntactic structures.

- (23) SEMANTIC COMPOSITIONALITY PRINCIPLE  
 In any well-formed phrase structure, the mother's RESTR value is the sum of the RESTR values of the daughters.

<sup>17</sup>For the purpose of this paper, the rules for gender resolution have been adopted in a somewhat simplified form. However, a more detailed study on gender resolution in Polish is needed with regard to morphosyntactic, semantic or, more precisely, pragmatic / contextual features, as well as combinations of these. The rules of Corbett (1983) do not seem to consider all possibilities of gender resolution in Polish.

<sup>18</sup>As an alternative, the extension of the ontology by a special subtype of *head-adjunct-structure* for PCCs could be considered, which would correspond to constructional HPSG approaches. The constraints on number, gender and person resolution would then apply to this particular type. Here, however, a fixed signature has been assumed, which should be kept as small as possible.

$$\begin{array}{c}
\forall \mathbb{1} \\
\left[ \begin{array}{c} \text{head-adjunct-structure} \\ \text{ADJUNCT-DTR} \left[ \begin{array}{c} \text{SYNS} \mid \text{LOC} \left[ \begin{array}{c} \text{CAT} \mid \text{HEAD} \mid \text{MORSYN} \mid \text{PFORM } z \\ \text{CONT} \mid \text{RESTR} \left\{ \left[ \text{NUCL CONJUNCTS } \mathbb{1}, \dots \right\} \right] \right] \right] \right] \end{array} \right] \end{array} \right] \dashrightarrow \\
\left( \begin{array}{c} \left( \begin{array}{c} \left[ \text{SYNS} \mid \text{LOC} \mid \text{CONT} \mid \text{INDEX} \mid \text{PERSON } 1st \right] \\ \wedge \exists \mathbb{2} \left( \text{member}(\mathbb{2}[\text{PERSON } 1st], \mathbb{1}) \right) \end{array} \right) \vee \\
\left( \begin{array}{c} \left[ \text{SYNS} \mid \text{LOC} \mid \text{CONT} \mid \text{INDEX} \mid \text{PERSON } 2nd \right] \\ \wedge \exists \mathbb{2} \left( \text{member}(\mathbb{2}[\text{PERSON } 2nd], \mathbb{1}) \right) \wedge \neg \exists \mathbb{3} \left( \text{member}(\mathbb{3}[\text{PERSON } 1st], \mathbb{1}) \right) \end{array} \right) \vee \\
\left( \begin{array}{c} \left[ \text{SYNS} \mid \text{LOC} \mid \text{CONT} \mid \text{INDEX} \mid \text{PERSON } 3rd \right] \\ \wedge \neg \exists \mathbb{2} \left( \mathbb{2}[\text{PERSON } 1st \vee 2nd] \right) \wedge \text{member}(\mathbb{2}, \mathbb{1}) \end{array} \right) \end{array} \right)
\end{array}$$

Figure 9: The principle of person resolution

(24) SEMANTIC INHERITANCE PRINCIPLE

In any headed phrase except for the head-adjunct phrase in which the adjunct daughter is headed by the comitative preposition *z*, the mother's INDEX values are identical to those of the head daughter.

The tree in Figure 10 displays the structure of the sentence in (6) according to the analysis proposed, and illustrates the interaction of the principles on number, gender and person resolution, as well as the above semantic principles.

By virtue of the lexical entry in Figure 6, the comitative preposition *z* 'with' is licensed, which selects for the instrumental NP *Mariq* 'Maria', forming an ordinary PP. The PP *z Mariq* 'with Maria' may be modified by collectivizing adverbs, such as *razem* 'together'. As a typical preposition, *z* 'with' undergoes a vocalic alternation when it appears in specific phonological environments (cf. *z Mariq* 'with Maria' vs. *ze Stasiem* 'with Staś'). The PP *z Mariq* 'with Maria' can also be conjoined with other comitative PPs (cf. (14)).

By means of constraints on adjunct-head-structures, the *z*-PP modifies the NP *Jan* 'Jan'. The phrase *Jan z Mariq* 'Jan and Maria' forms a head-adjunct-structure. With the exception of the INDEX value, the phrase *Jan z Mariq* 'Jan and Maria' is a result of applying the standard principles of grammar, such as THE HEAD FEATURE PRINCIPLE or THE SEMANTIC COMPOSITIONALITY PRINCIPLE. The INDEX value of the phrase *Jan z Mariq* 'Jan and Maria' is constructed by the constraints on number, gender and person resolution in Figure 7, Figure 8 and Figure 9, respectively. The resulting INDEX value serves as an agreement controller.

Note, however, that the phrase *Jan z Mariq* 'Jan and Maria' also contains a *singular* valued NUMBER feature (see [7]). The mixed specification of NUMBER values on this phrase allows one to account for sentences as in (25).

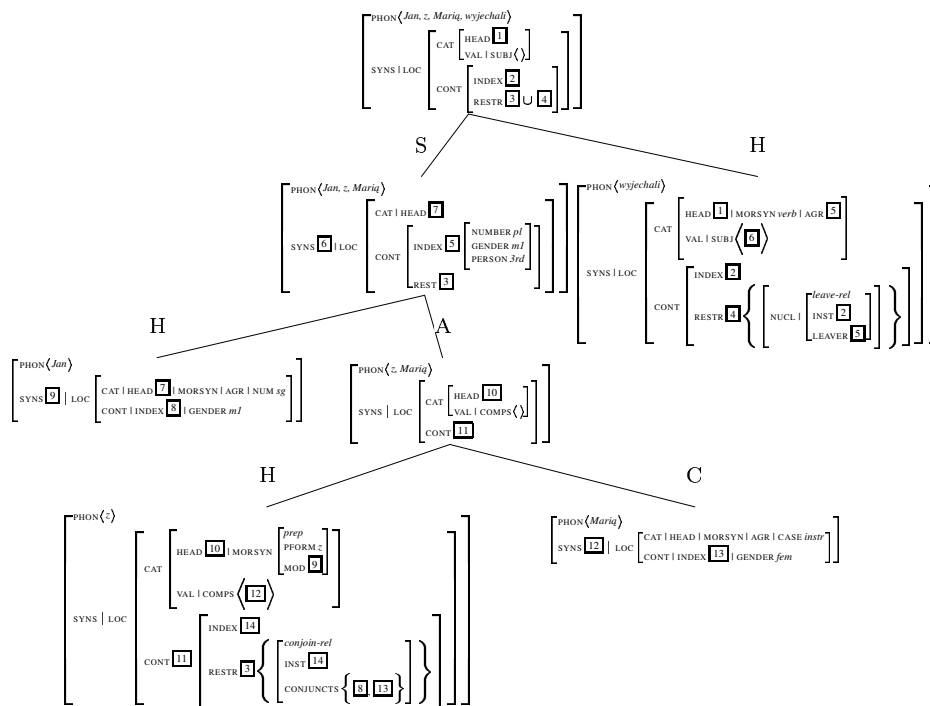

Figure 10: The structure of the sentence *Jan z Marią wyjechali* ‘Jan and Maria left’

- (25) a. *Polski prezydent z premierem wyjechali.*  
 Polish.SG president.SG with prime minister.SG left.PL  
 ‘The Polish president and the prime minister left.’
- b. *Przybył prezydent z premierem, długo oczekiwani.*  
 arrived.SG president.SG with prime minister.SG long expected.PL  
 ‘The president and the prime minister, expected for a long time, arrived.’

In (25a), the PCC *prezydent z premierem* ‘the president and the prime minister’ combines with a plural predicate and a singular adjective.<sup>19</sup> In (25b), the PCC occurs with both a singular predicate and a plural participle at the same time.

## 6 Summary and Outlook

In this paper, crucial properties of Polish PCCs have been discussed, and shortcomings of previous approaches to PCCs have been presented. An adjunction-based HPSG analysis has been proposed that accounts for number, gender and

<sup>19</sup>Note, however, that the sentence in (25a) has two readings. According to the first one, the adjective modifies only the first NP, i.e., *prezydent* ‘president’. According to the second reading, the adjective modifies the entire PCC, i.e., *prezydent z premierem* ‘the president and the prime minister’. For pragmatic reasons, the second reading is preferred.



person resolution, coreference phenomena, modifiability by collectivizing adverbs, idiosyncratic properties of PCCs, mixed agreement, and other features of PCCs.

This analysis accounts for the syntactic and semantic properties of PCCs in Polish by (i) assuming an adjunction-based syntactic structure for PCCs, (ii) describing idiosyncratic properties of PCCs, such as the symmetry of NPs involved in PCCs, and ensuring a uniform theta-role assignment to these NPs by the lexical entry of the preposition *z* ‘with’, and (iii) assuming that indices of PCCs are not subject to any inheritance or composition, but are constructed by a set of principles on number, gender and person resolution, which also apply to ordinary coordinate structures.

In future work, other types of comitative constructions will be investigated with the goal being the uniform treatment of all Polish comitatives.

## References

- Abeillé, Anne. 2003. A Lexicon- and Construction-Based Approach to Coordinations. In Stefan Müller (ed.), *Proceedings of the HPSG-2003 Conference, Michigan State University, East Lansing*, pages 5–25, CSLI Publications.
- Aissen, Judith L. 1989. Agreement Controllers and Tzotzil Comitatives. *Language* 65, 518–535.
- Camacho, José. 1994. Comitative Coordination in Spanish. In Claudia Parodi, Carlos Quicoli, Mario Saltarelli and María Luisa Zubizarreta (eds.), *Aspects of Romance Linguistics*, pages 107–122, Washington D.C.: Georgetown University Press.
- Comacho, José. 1994. Comitative Coordination in Spanish. In Claudia Parodi, Carlos Quicoli, Mario Saltarelli and María Luisa Zubizarreta (eds.), *Aspects of Romance Linguistics*, Selected Papers from the Linguistic Symposium on Romance Languages, No. XXIV, pages 107–122, Washington, D.C.: Georgetown University Press.
- Comacho, José. 2000. Structural Restrictions on Comitative Coordination. *Linguistic Inquiry* 31, 366–375.
- Corbett, Greville G. 1983. *Hierarchies, Targets and Controllers: Agreement Patterns in Slavic*. University Park: Pennsylvania State University Press.
- Czuba, Krzysztof and Przepiórkowski, Adam. 1995. Agreement and Case Assignment in Polish: An Attempt at a Unified Account. Technical Report 783, Institute of Computer Science, Polish Academy of Sciences.
- Dalrymple, Mary, Hayrapetian, Irene and King, Tracy Holloway. 1998. The Semantics of the Russian Comitative Construction. *Natural Language and Linguistic Theory* 16, 597–631.

- Davidson, Donald. 1967. The Logical Form of Action Sentences. In Nicholas Rescher (ed.), *The Logic of Decision and Action*, Pittsburgh: University of Pittsburgh Press.
- den Dikken, Marcel, Lipták, Anikó and Zvolenszky, Zsófia. 2001. On Inclusive Reference Anaphora: New Perspectives from Hungarian. In K. Megerdooian and L. A. Bar-el (eds.), *WCCFL 20 Proceedings*, pages 137–149, Somerville, MA: Cascadilla Press.
- Dyła, Stefan. 1988. Quasi-Comitative Coordination in Polish. *Linguistics* 26, 383–414.
- Dyła, Stefan. 2003. Note on Gender Resolution in the Plural Pronoun Construction in Polish. *Glott International* 7(3), 383–414.
- Dyła, Stefan and Feldman, Anna. to appear. On Comitative Constructions in Polish and Russian. In *Proceedings of the Fifth European Conference on Formal Description of Slavic Languages*, Leipzig, Germany.
- Feldman, Anna. 2002. On NP-Coordination. In Sergio Baauw, Mike Huiskes and Maaïke Schoorlemmer (eds.), *Yearbook 2002*, pages 39–67, Utrecht Institute of Linguistics OTS.
- Ionin, Tania and Matushansky, Ora. 2002. DPs with a Twist: A Unified Analysis of Russian Comitatives. In *Proceedings of FASL 11*, Amherst, MA.
- Kathol, Andreas. 1999. Agreement and the Syntax-Morphology Interface in HPSG. In Robert Levine and Georgia Green (eds.), *Studies in Contemporary Phrase Structure Grammar*, pages 209–260, Cambridge and New York: Cambridge University Press.
- Ladusaw, William A. 1989. Group Reference and the Plural Pronoun Construction. In *Papers on the Plural Pronoun Construction and Comitative Coordination*, pages 1–7, UCSC Syntax Research Center Report SRC-89-02.
- Link, Godehard. 1991. Plural. In Arnim von Stechow and Dieter Wunderlich (eds.), *Semantik. Ein internationales Handbuch der zeitgenössischen Forschung [Semantics. An International Handbook of Contemporary Research]*, pages 418–440, Berlin and New York: Walter de Gruyter.
- Mańczak, Witold. 1956. Ile jest rodzajów w polskim? [How Many Genders are There in Polish?]. *Język Polski* XXXVI (2), 116–121.
- Marciniak, Małgorzata. 2001. *Zastosowanie formalizmu HPSG do opisu koreferencji zaimków dla języka polskiego [Application of the HPSG Formalism to the Description of Pronominal Anaphora in Polish]*. Ph. D.thesis, Institute of Computer Science, Polish Academy of Sciences, Warsaw, Poland.

- McNally, Louise. 1993. Comitative Coordination: A Case Study in Group Formation. *Natural Language and Linguistic Theory* 11, 347–379.
- Montague, Richard. 1974. The Proper Treatment of Quantification in Ordinary English. In Richmond H. Thomason (ed.), *Formal Philosophy. Selected Papers of Richard Montague*, pages 247–270, Yale University Press.
- Pollard, Carl J. and Sag, Ivan A. 1994. *Head-Driven Phrase Structure Grammar*. Chicago: The University of Chicago Press.
- Progovac, Ljiljana. 1997. Slavic and the Structure for Coordination. In Martina Lindseth (ed.), *Formal Approaches to Slavic Linguistics 5: The Indiana Meeting 1996*, pages 207–223, Ann Arbor: Michigan Slavic Publications.
- Przepiórkowski, Adam, Kupść, Anna, Marciniak, Małgorzata and Mykowiecka, Agnieszka. 2002. *Formalny opis języka polskiego: Teoria i implementacja [A Formal Description of the Polish Language: Theory and Implementation]*. Warszawa: Akademicka Oficyna Wydawnicza EXIT.
- Reinders-Machowska, Ewa. 1991. Binding in Polish. In Jan Koster and Eric Reuland (eds.), *Long-Distance Anaphora*, pages 137–150, Cambridge: Cambridge University Press.
- Ross, John Robert. 1967. *Constraints on Variables in Syntax*. Ph.D.thesis, MIT, Cambridge, USA, appeared as Ross (1986): *Infinite Syntax*. Ablex Publishing Corporation, Norwood, New Jersey.
- Sag, Ivan A., Wasow, Thomas and Bender, Emily M. 2003. *Syntactic Theory: A Formal Introduction*. Stanford: CSLI Publications, second edition.
- Saloni, Zygmunt and Świdziński, Marek. 1998. *Składnia współczesnego języka polskiego [The Syntax of Contemporary Polish]*. Warszawa: Wydawnictwo Naukowe PWN, fourth edition.
- Schwartz, Linda. 1988. Conditions for Verb-Coded Coordinations. In Michael Hammond, Edith Moravcsik and Jessica Wirth (eds.), *Studies in Syntactic Typology*, Typological Studies in Language (TSL), pages 53–73, Amsterdam/Philadelphia: John Benjamins Publishing Company.
- Vassilieva, Maria B. and Larson, Richard K. 2001. The Semantics of the Plural Pronoun Construction. In R. Hastings, B. Jackson and Z. Zvolenszky (eds.), *Proceedings of Semantics and Linguistic Theory (SALT) XI*, Ithaca: CLC Publications, Dept. of Linguistics, Cornell University.
- Wechsler, Stephen and Zlatić, Larisa. 2001. A Theory of Agreement and its Application to Serbo-Croatian. *Language* 76.4, 799–832.

# A head-driven treatment of asymmetric coordination and apposition

Frank Van Eynde 

University of Leuven

Proceedings of the 12th International Conference on  
Head-Driven Phrase Structure Grammar

Department of Informatics, University of Lisbon

Stefan Müller (Editor)

2005

Stanford, CA: CSLI Publications

pages 396–409

Van Eynde, Frank. 2005. A head-driven treatment of asymmetric coordination and apposition. In Stefan Müller (ed.), *Proceedings of the 12th International Conference on Head-Driven Phrase Structure Grammar, Department of Informatics, University of Lisbon*, 396–409. Stanford, CA: CSLI Publications. DOI: 10.21248/hpsg.2005.23.



## Abstract

In Pollard and Sag (1994) and Ginzburg and Sag (2000) phrases are either headed or non-headed, and if they are headed, there is a relation of selection between the daughters: either the head daughter selects its non-head sister(s), as in the phrases of type *head-complements*, or the non-head daughter selects its head sister, as in the phrases of type *head-adjunct*. In the non-headed phrases, by contrast, there is no selection; in a coordinate structure, for instance, there is no relation of selection, neither between the conjuncts nor between the conjunction and the conjuncts. The central claim of this paper is that there are also phrases which are headed but in which neither daughter selects the other. To model such phrases I propose a new type, called *head-independent*. Its properties are spelled out and its range of application is illustrated with various examples, including asymmetric coordination and apposition.

## 1 Introduction

The main claim of this paper is that there are certain types of phrases which are headed but which cannot properly be modeled in terms of the usual inventory of phrase (structure) types. To demonstrate this I will provide examples and analyses of prenominal APs, subject NPs and prenominal NPs. The examples are all taken from Dutch, but their analysis is defined in terms which are sufficiently general to be applicable to other languages as well.

## 2 Prenominal APs

In Dutch, the prenominal adjectives show morpho-syntactic agreement with the nouns they modify. More specifically, they take the base form if the noun is singular neuter, and the declined form otherwise. Compare, for instance, the singular neuter *een zwart paard* ‘a black horse’ with the singular nonneuter *een zwarte ezel* ‘a black-DCL donkey’ and the plural *zwarte paarden* ‘black-DCL horses’.<sup>1</sup> If the prenominal is a phrase, rather than a single word, then it is the adjectival head of the prenominal which hosts the declension affix, as in the plural *zeer snelle paarden* ‘very fast-DCL horses’ and the singular nonneuter *een van Rusland afhankelijke staat* ‘a from Russia dependent-DCL state’.

---

<sup>†</sup>I would like to thank the anonymous reviewers of the abstract and the non-anonymous attendants of the conference whose comments and questions have provided me with so much food for thought and (re)consideration that this text only remotely resembles the original submission.

<sup>1</sup>In NPs with a definite determiner the adjectives are also declined if the noun is singular neuter, as in *het zwarte paard* ‘the black-DCL horse’. To neutralize this factor I will use nominals without determiner or with an indefinite determiner for exemplification.

## 2.1 Two types of coordination

If a prenominal AP takes the form of a coordinate structure, the declension affix materializes on all of the conjuncts, as in the direct object NP of (1).

- (1) Hij heeft witte en zwarte truien gekocht.  
he has white-DCL and black-DCL sweaters bought  
'He bought white and black sweaters.'

This, however, is not the only possibility. There is also a (less common) type of coordination, in which the declension affix only appears on the last conjunct, as in (2).<sup>2</sup>

- (2) Hij heeft wit en zwarte truien gekocht.  
he has white and black-DCL sweaters bought  
'He bought white and black sweaters.'

This syntactic difference correlates with a semantic one. While the NP in (1) denotes a set of sweaters which includes both white exemplars and black ones, its counterpart in (2) denotes a set of bi-coloured sweaters. In other words, while the conjuncts in the symmetric coordination denote mutually distinct properties, i.e. the property of being white and the property of being black, the conjuncts in the asymmetric coordination jointly denote one property, i.e. the property of being black and white. There is, hence, a close semantic link between the conjuncts in the asymmetric coordination. This is mirrored by the syntactic peculiarity that they cannot be separated. Extraposition of the final conjunct, for instance, is possible in the symmetric type of coordination, but not in the asymmetric one.

- (3) Hij heeft witte truien gekocht en zwarte (ook).  
he has white-DCL sweaters bought and black-DCL (too)  
'He bought white sweaters and black ones (too).'
- (4) \*Hij heeft wit truien gekocht en zwarte (ook).  
he has white sweaters bought and black-DCL (too)

Similarly, it is possible to insert a prenominal between both adjectives in a symmetric coordination, but not in an asymmetric one.

- (5) Hij heeft drie witte en twee zwarte truien gekocht.  
he has three white-DCL and two black-DCL sweaters bought  
'He bought three white sweaters and two black ones.'
- (6) \*Hij heeft drie wit en twee zwarte truien gekocht.  
he has three white and two black-DCL sweaters bought

---

<sup>2</sup>If the affix is only realized on a non-final conjunct, as in \**witte en zwart truien* 'white-DCL and black sweaters', the resulting phrase is ungrammatical.

In sum, there is a close link between the conjuncts in the asymmetric type, both semantically and syntactically. This link, though, is not so close that it justifies the treatment as a single syntactic atom. Notice, for instance, that the conjuncts can be permuted without changing the meaning or the well-formedness: *zwart en witte truien* is synonymous with and equally well-formed as *wit en zwarte truien*. They can also be replaced by other adjectives, as in *rood en gele truien* ‘red and yellow-DCL sweaters’, and they can take their own modifiers, especially incorporated ones, as in *donkerblauw en lichtgroene truien* ‘dark-blue and light-green-DCL sweaters’. This demonstrates that the asymmetric coordinate structures are phrases, rather than single words. For the declension marker, this implies that it cannot be treated as an affix which is added to a morphologically complex word, as in *(wit-en-zwart)+e truien*; instead, it is what it seems to be, i.e. an affix which is only realized on the last conjunct, as in *wit en zwart+e truien*.

## 2.2 Symmetric coordination in prenominal APs

To model the combination of a noun with a prenominal AP I adopt the analysis of Allegranza (1998) and Van Eynde (2003), in which the noun is the head and the prenominals its functors. The defining characteristic of functors is that they are non-head daughters which select their head sister. In terms of the Pollard and Sag (1994) inventory of phrase types, they include the adjuncts, the specifiers and the markers.<sup>3</sup> The selection is modeled in terms of a *synsem* valued feature SELECT, which is part of the functor’s HEAD value.<sup>4</sup>

$$(7) \left[ \begin{array}{l} \text{head-functor-phr} \\ \text{DTRS} \left\langle \left[ \text{SYNSEM} \mid \text{LOC} \mid \text{CAT} \mid \text{HEAD} \mid \text{SELECT} \quad \boxed{1}, \boxed{2} \right] \right\rangle \\ \text{HEAD-DTR} \quad \boxed{2} \left[ \text{SYNSEM} \quad \boxed{1} \text{synsem} \right] \end{array} \right]$$

The value of the SELECT feature can be used to model NP-internal agreement. The Dutch nondeclined prenominal adjectives, for instance, can be stipulated to select a singular neuter nominal, whereas their declined counterparts can be claimed to select a nominal which is either plural or singular nonneuter. Since the SELECT feature is part of the HEAD value, it is shared between the adjective and the AP which it projects, as in:<sup>5</sup>

<sup>3</sup>The notion ‘functor’ is also used in a broader sense. In (Reape, 1994, 154), for instance, it covers all kinds of selectors, including the heads in head-complement combinations. In my use the term only covers the selecting non-head daughters.

<sup>4</sup>The SELECT feature is a generalization of the MOD and SPEC features of Pollard and Sag (1994). For a similar proposal to replace MOD and SPEC with a single selection feature, see Soehn and Sailer (2003). Non-head daughters which do not select their head sister have the SELECT value *none*. Predicative adjectives, for instance, are complements, rather than functors, and therefore have the SELECT value *none*.

<sup>5</sup>Throughout the paper, I use the notation XP for all phrasal signs, no matter whether they are fully saturated or not.

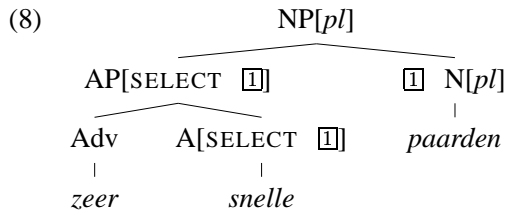

Combining the functor treatment with the Pollard and Sag (1994) treatment of coordination the symmetric coordination of prenominal adjectives can be analysed as follows.

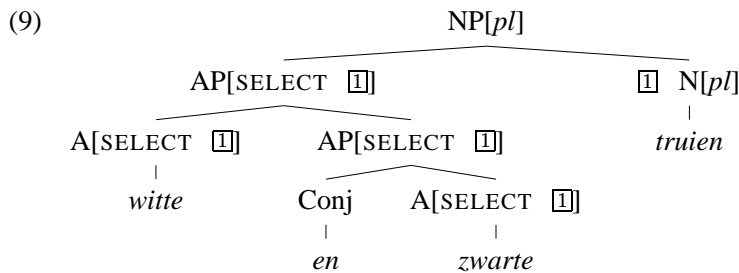

The propagation of the SELECT value over both conjuncts follows from the strong version of the Coordination Principle, which requires the conjunct daughters to share the CATEGORY and NONLOCAL value of the mother (Pollard and Sag, 1994, 202). As for the relation between the conjunction and the conjunct which it introduces, it is not spelled out in Pollard and Sag (1994) how it can be modeled. Taking into account that it is the conjunct and not the conjunction which shares its HEAD value with the mother, I assume that it is a headed type of phrase in which the conjunct is the head daughter and the conjunction its functor.<sup>6</sup>

### 2.3 Asymmetric coordination in prenominal APs

Turning now to the asymmetric coordination in *wit en zwarte truien*, it seems logical to treat the final conjunct as the head daughter of the AP, for in that case we automatically predict that it is this conjunct which shows variation for declension and which shares its SELECT value with the phrase.

However, surveying the inventory of headed phrase types, there is none which looks appropriate to capture the particular properties of the asymmetric coordination. Treating the head as a selector is not attractive, for in that case the first conjunct must be a complement or a subject of the second one, both of which are implausible. More specifically, the complement treatment is implausible, since color denoting adjectives, such as *zwarte*, are not supposed to take any complements, and the subject treatment is implausible, since prenominal adjectives do not

<sup>6</sup>The *select* value of the conjunction cannot be very specific, since conjunctions combine with nearly anything. The fact, though, that it is of type *synsem* is significant, since it implies that there has to be some conjunct.



take a subject; instead their first argument is realized by the nouns they modify. The alternative of treating the non-head daughter as the selector is not very attractive either, for in that case the nondeclined adjectives must be assigned a disjunctive SELECT value: one for selecting a singular neuter nominal (see 2.2) and one for selecting an AP which is introduced by a conjunction. Moreover, it is not only the systematic ambiguity which is unattractive, there is also the problem that the selection of one conjunct by another does not mesh well with the intuitive notion of selection: there is no intuitively clear sense in which *wit* can be claimed to select the final conjunct in *wit en zwarte truien*. In this respect, it resembles the symmetric coordination in *witte en zwarte truien*, for which it is commonly assumed that there is no selection either. So, unless one is prepared to resort to a totally novel notion of selection, it is unattractive to treat the first conjunct as the selector of the second one. This leaves us with a problem, though, for if neither daughter selects the other, then there is no existing phrase type which can be used to model the asymmetric coordination, at least if we limit ourselves to the usual inventory of headed phrase types.

Looking beyond the usual inventory, there is one which comes close to meeting the requirements. It concerns a type of headed phrase in which neither daughter selects the other. It is mentioned in Van Eynde (1998) under the name *head-independent-phrase*, but its role in the grammar and its properties have so far been left implicit. To repair this I now propose the following definition.

$$(10) \left[ \begin{array}{l} \textit{head-independent-phr} \\ \text{DTRS} \left\langle \left[ \text{SYNSEM} \mid \text{LOC} \left[ \begin{array}{l} \text{CAT} \mid \text{HEAD} \mid \text{SELECT } \textit{none} \\ \text{CONT} \mid \text{INDEX } \boxed{1} \end{array} \right] \right], \boxed{2} \right\rangle \\ \text{HEAD-DTR } \boxed{2} \left[ \text{SYNSEM} \mid \text{LOC} \mid \text{CONT} \mid \text{INDEX } \boxed{1} \right] \end{array} \right]$$

The defining property of the phrases of type *head-independent* is that both daughters have the same index ( $\boxed{1}$ ). This captures the fact that the conjuncts jointly denote a single property. The adjectives in *wit en zwarte truien*, for instance, jointly denote the property of being partly white and partly black. As such, they contrast with the adjectives in the symmetric *witte en zwarte truien*, in which the conjuncts denote distinct and even mutually exclusive properties.

The asymmetric nature of the coordination is captured by the assignment of head status to the final conjunct: the head daughter ( $\boxed{2}$ ) is identified with the rightmost daughter.<sup>7</sup> As such, it shares its HEAD value with the mother, including the SELECT feature. The absence of any relation of selection between the daughters is captured by the lack of a reference to the valence features and by the assignment of the value *none* to the SELECT feature of the non-head daughter. Independent evidence for this assignment is provided by the fact that the adjective in the first conjunct does not show variation for declension, for this lack of variation is a defining

<sup>7</sup>This is consistent with the commonly held view that Dutch is predominantly head-final.

property of adjectives with the value *none*. The adjectives in predicative positions, for instance, are also invariably nondeclined, see footnote 4.

Employing this new phrase type, the analysis of the nominal with an asymmetrically coordinated AP can be modeled as follows.

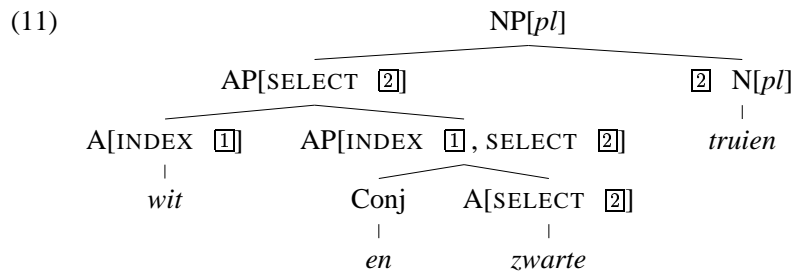

The INDEX value is shared between the conjuncts, but it is only the last conjunct which shares its SELECT value with the AP as a whole.

## 2.4 Some related constructions

As might be expected, the distinction between symmetric and asymmetric coordination is not only applicable to conjunction, but also to disjunction. In *witte of zwarte truien* ‘white-DCL or black-DCL sweaters’, for instance, the coordination is symmetric and distributive, in the sense that it can be paraphrased as *witte truien of zwarte truien*. By contrast, the AP in *een of andere kerel* ‘one or other-DCL guy’, is asymmetric and non-distributive. It is only the last conjunct which is declined, even though the first one does have a declined counterpart (*ene* ‘one-DCL’), and it cannot be paraphrased as *een kerel of andere kerel*. This is due to the fact that the conjuncts jointly denote a single property, rather than a disjunction of mutually distinct properties.

Another instance of asymmetric coordination is provided by the prenominal APs in *de Frans-Duitse grens* ‘the French-German-DCL border’ and *financieel-economische berichten* ‘financial-economic-DCL messages’. The conjuncts in these examples jointly denote a single property and are asymmetric, but in contrast to the previous examples, they are not separated by a conjunction. Instead, they are simply juxtaposed.<sup>8</sup>

What is less expected perhaps, is that the final conjunct can also be introduced by a preposition. Let us, for instance, take the APs in *een zwart met bruine mantel* ‘a black with brown-DCL coat’ and *een goud met rode zonsondergang* ‘a gold with red-DCL sunset’, both quoted from (Haeseryn et al., 1997, 407). The second example is especially interesting since its first conjunct is a noun (*goud*) rather than an adjective (*gouden*). This makes the asymmetric nature of the phrase more conspicuous and provides clear evidence for the assumption that it is the rightmost daughter which heads the phrase.

<sup>8</sup>The presence of the hyphen is a matter of orthographic convention; in spoken language there is no overt sign which separates the adjectives.

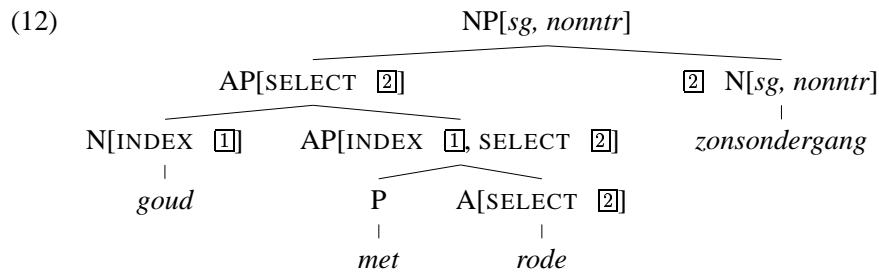

Notice that the preposition in this combination is not the head of a PP, but a non-head sister in an adjectival projection. The difference between complement selecting (major) prepositions, which are heads of PPs, and head selecting (minor) prepositions, which are non-head sisters in XP projections, is motivated and exemplified extensively in Van Eynde (2004).

### 3 Asymmetric coordination in NPs

To illustrate the relevance of the distinction between symmetric and asymmetric coordination for NPs, let us take the following pair of sentences.

- (13) Zijn beste vriend en zijn lief hebben hem bedrogen.  
 his best friend and his girlfriend have him cheated  
 ‘His best friend and his girlfriend have cheated on him.’
- (14) Zijn beste vriend en kamergenoot heeft hem bedrogen.  
 his best friend and roommate has him cheated  
 ‘His best friend and roommate has cheated on him.’

In the symmetric type of coordination, the conjuncts denote mutually distinct entities and since the sum of two singulars gives a plural, the resulting NP requires the finite verb to be plural. By contrast, in (14) the conjuncts jointly denote a single individual, so that the resulting NP requires the finite verb to be singular. This clearly suggests that we have another instance of the head-independent phrase type. More specifically, we have an instance of asymmetric coordination, in which the rightmost conjunct shares its NUMBER value with the NP.

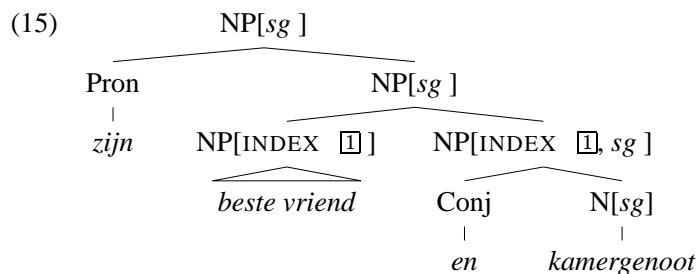

The index sharing guarantees that the conjuncts have the same referent and the fact that the last conjunct is the head accounts for the singular nature of the NP as a whole.

As in the case of the prenominal APs, it is not necessary that the head daughter be introduced by a conjunction. It can also be introduced by a preposition. To illustrate this, let us take the NP *een schat van een kind* ‘a treasure of a child’. This NP is ambiguous: it can have the usual interpretation of a noun with a postnominal PP and denote some treasure which belongs to a child, but it also has a second interpretation, in which the child is said to be very precious. In that interpretation, *kind* is the semantic head of the NP, and *schat* its prenominal dependent (Haeseryn et al., 1997, 854). Other examples of this kind are *een kast van een huis* ‘a castle of a house’, *een boom van een kerel* ‘a tree of a guy’ and *een serpent van een wijf* ‘a snake of a woman’. The secondary interpretation can only be obtained under certain conditions. First, the head noun must be indefinite: *een schat van dat kind* ‘a treasure of that child’ can only have the first (N+PP) interpretation. Second, the qualifying noun must have the same number as the head noun; they must both be singular, as in the previous examples, or they must both be plural, as in *schatten van kinderen* ‘treasures of children’. Mixtures, as in *schatten van een kind* ‘treasures of a child’ and *een schat van kleine kinderen* ‘a treasure of small children’ can only have the first (N+PP) interpretation.

To model the secondary interpretation, I assume that the second noun is not only the semantic head of the entire NP, but also its syntactic head. This implies that the preposition *van* ‘of’ is not the head of a PP, but a minor functor, and that the first noun is a prenominal non-head sister of the *van*+NP combination.

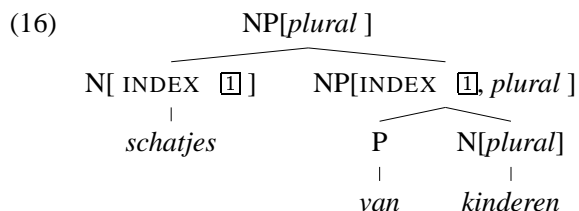

The relation between the modifying noun and the head noun is once again a typical instance of the head-independent type of combination, for, first, they jointly denote one and the same group of individuals, which implies that they have the same index, and second there is no relation of selection between them.

#### 4 Prenominal NPs

NPs which are used in prenominal position, such as genitives, possessives and numerals, can also take the form of head-independent phrases.

#### 4.1 Prenominal genitives as functors

In contrast to the APs, the prenominal NPs do not show morpho-syntactic agreement with the nouns they modify. The pronoun in *wiens paarden* ‘who-GEN horses’, for instance, is singular, masculine and genitive, whereas the modified noun is plural, neuter and non-genitive. This lack of morpho-syntactic agreement, however, does not imply that there are no constraints on the combination of a prenominal NP and its nominal head sister. To mention just one, a genitive NP can only be combined with a nominal which is not fully saturated, such as the bare plural *paarden*, and yields a nominal which is fully saturated, in the sense that it can no longer be combined with a determiner, as in *(\*de) wiens paarden*. As demonstrated in Van Eynde (2003), these constraints can be captured straightforwardly in terms of the functor treatment of the prenominals.

Predictably, if the prenominal genitive is not a single word but a phrase, the requirement for an unsaturated nominal is shared with the head daughter of the genitive NP; moreover, it is also on that daughter that the genitive affix is realized. In *mijn vaders vrienden* ‘my father-GEN friends’, for instance, the genitive *-s* is added to *vader*. Since CASE is a HEAD feature, just like SELECT, this can be modeled as follows:

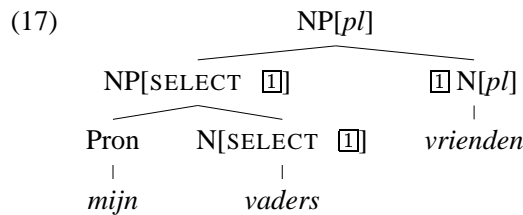

In words, *mijn vaders* is genitive and selects an unsaturated nominal, because its head daughter has these properties. The possessive pronoun *mijn* ‘my’ is in its turn a functor of *vaders*.

#### 4.2 Apposition in prenominal genitives

Let us now examine the genitives in *met ons aller instemming* ‘with us all-GEN consent’ and *in u beider voordeel* ‘in you both-GEN advantage’. In both examples, the prenominal is an NP which consists of a pronoun and a genitive nominal. This is clear a.o. from the fact that in the alternative postnominal realization both the pronoun and the genitive appear after the nominal, as in *met de instemming van ons allen* ‘with the consent of us all-PL’ and *in het voordeel van u beiden* ‘in the advantage of you both-PL’. In this respect, there is an obvious similarity with *mijn vaders vrienden*, which in its postnominal realization takes the form of *de vrienden van mijn vader* ‘the friends of my father’. Another similarity concerns the fact that the genitive affix is added to the last word of the NP: it is the quantifying *aller* and *beider* which bear the genitive plural *-er*, whereas the preceding pronoun is

accusative.<sup>9</sup>

At the same time, there are also some important differences between *u beider voordeel* and *mijn vaders vrienden*. For a start, while the possessive and the noun in *mijn vaders* have mutually distinct denotations, the personal pronoun and the quantifying genitive in *u beider* jointly denote one and the same set of individuals. This accounts for the fact that the number value of the possessive may differ from the one of its head, whereas there is number agreement between the personal pronoun and the quantifying genitive in *u beider*. More specifically, since *beider* and *aller* are inherently plural, the preceding pronoun must be plural too, cf. *ons/u/\*mij/\*hem aller* ‘us/you/\*me/\*him all-GEN’. Second, while the possessive pronoun in *mijn vaders* can naturally be treated as a functor which selects an unsaturated nominal and which yields a saturated NP, the personal pronoun *u* does not qualify as a selector of *beider*, since it is typical of personal pronouns that they only select a nominal when they are genitive, not when they are accusative.

An analysis which neatly captures both the similarities and the differences between both types of genitives is the one in which *u beider* is treated as a phrase of type *head-independent*.

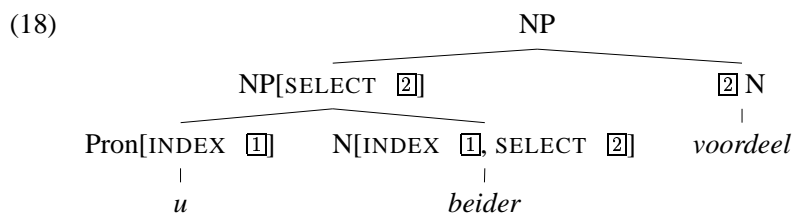

In this analysis, the genitive *beider* is the head daughter of the genitive NP, while the personal pronoun *u* is its non-head sister. Given the general constraint that the SELECT value of the non-head daughter must be *none*, the analysis automatically and correctly predicts that the personal pronoun cannot take the genitive form, for if it were genitive, it would select an unsaturated nominal and have a SELECT value of type *synsem*.

### 4.3 Prenominal possessives

While the prenominal genitives belong to a formal register, there is a semantically equivalent construction which is distinctly informal. It consists of a possessive pronoun preceded by an NP in standard case, as in *Jan zijn fiets* ‘John his bike’. This

<sup>9</sup>There is a tendency to replace the personal pronoun with a possessive one, as in *in uw beider voordeel* ‘in your both-GEN advantage’ (Haeseryn et al., 1997, 356). Backing this up, a Google search, carried out in February 2005, yielded 795 occurrences of *u aller* vs. 4306 of *uw aller*, and 285 occurrences of *u beider* vs. 782 of *uw beider*. While the use of the possessive can be seen as a simplification, since it is much more common for a possessive to occur in a prenominal position than for an accusative pronoun, it also complicates the relation between syntax and semantics, since the meaning of the possessive in *in uw beider voordeel* is still the one of a personal pronoun, as demonstrated by fact that the corresponding postnominal is not *in uw voordeel van beiden*, but rather *in het voordeel van u/\*uw beiden* ‘the advantage of you/\*your both’.

construction is rarely used in written language, but it is very common in colloquial Dutch (Haeseryn et al., 1997, 294).

The NP which precedes the possessive cannot only be a proper noun, such as *Jan*, but also a pronoun, as in *iemand z'n fiets* ‘somebody his bike’ or a common noun with a definite determiner, as in *mijn zus haar schoenen* ‘my sister her shoes’ and *die mannen hun kinderen* ‘those men their children’. The possessive and the preceding NP denote one and the same (group of) individual(s) and must, hence, share their index. The ensuing number agreement accounts for the contrast in *die mannen hun/\*z'n/\*haar kinderen* ‘those men their/\*his/\*her children’, and the ensuing gender agreement accounts for the contrast in *mijn zus haar/\*zijn schoenen* ‘my sister her/\*his shoes’. Moreover, since the preceding NP is invariably of the third person, it also accounts for the fact that the possessives in this construction must be of the third person, cf. *iemand z'n/\*je/\*m'n kinderen* ‘somebody his/\*your/\*my children’. Since index sharing is a defining property of the head-independent phrase type, it is a plausible candidate for the analysis.

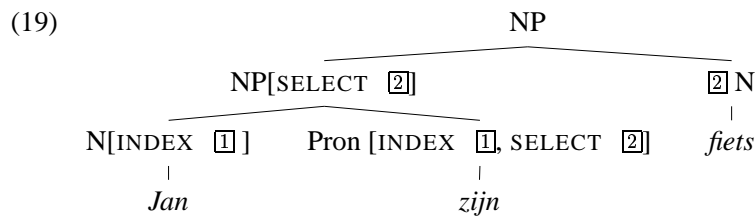

Further evidence for this treatment is provided by the fact that there is no relation of selection between the daughters. Possessive pronouns do not take any subjects or complements, and NPs do not select possessives: it would, for instance, be farfetched and unintuitive to claim that *Jan* selects the possessive *zijn*.

#### 4.4 Prenominal numerals

Returning to the main theme, we have seen in this section that there are prenominal NPs, notably among the genitive and possessive ones, which show the characteristic properties of the head-independent type of combination. The examples all concerned combinations in which the head daughter is not introduced by any closed class word. They are, hence, instances of juxtaposition.

To demonstrate that there are also cases in which the head daughter is introduced by a conjunction, let us take the quantifying prenominal in *een stuk of dertig pagina's* ‘a piece or thirty pages’. This prenominal contains an indefinite NP, the conjunction *of* ‘or’ and a numeral. Its meaning can be paraphrased as ‘around thirty’, and has little to do with disjunction. In contrast to *twintig of dertig pagina's* ‘twenty of thirty pages’, which can be paraphrased as *twintig pagina's of dertig pagina's* ‘twenty pages or thirty pages’, it cannot be paraphrased as *een stuk pagina's of dertig pagina's* ‘a piece pages or thirty pages’. As a matter of fact, the first conjunct is not even compatible with a plural count noun: \**een stuk pagina's*. Hence, the two parts of the coordination do not denote different amounts, but rather

one and the same amount, and it is only the second part which requires a plural count noun: the first conjunct does not share this requirement. This strongly suggests that the numeral *een stuk of dertig* is another instance of the head-independent phrase type.<sup>10</sup>

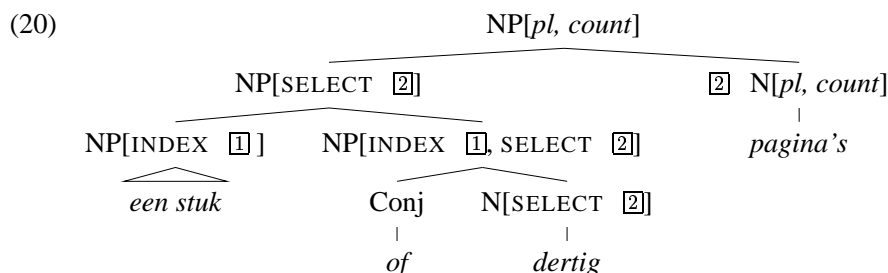

Both parts of the prenominal are NPs, but it is only the latter which shares its HEAD value and, hence, its SELECT value with the prenominal as a whole.

## 5 Conclusion

Some phrases, such as the prenominal AP in *wit en zwarte truien* ‘white and black-DCL sweaters’, show an unusual mixture of properties, for on the one hand there is some good evidence that they are headed, but on the other hand none of the familiar headed phrase types is well equipped to deal with them. To model such combinations, I have employed a type of phrases, called *head-independent-phrase*, building on a proposal in Van Eynde (1998). Typical of the phrases of this type is that they are right-headed, that neither daughter selects the other, and that the daughters share their index. The new phrase type is not only useful to model cases of asymmetric coordination, but also of apposition, as in *u beider voordeel* ‘you both-DCL advantage’ and *Jan z’n fiets* ‘John his bike’, and of some other idiosyncratic combinations, such as *een schat van een kind* in the meaning of ‘a very precious child’.

## References

- Allegranza, V. 1998. Determiners as Functors: NP structure in Italian. In S. Balari and L. Dini (eds.), *Romance in HPSG*, pages 55–107, Stanford: CSLI Publications.
- Ginzburg, J. and Sag, I. 2000. *Interrogative Investigations*. Stanford: CSLI.
- Haeseryn, W., Romijn, K., Geerts, G., de Rooij, J. and van den Toorn, M.C. 1997. *Algemene Nederlandse Spraakkunst*. Nijhoff and Wolters Plantyn.

<sup>10</sup>For evidence that the numerals are nouns, see Jackendoff (1977).



- Jackendoff, R. 1977. *X-bar syntax: a study of phrase structure*. MIT Press.
- Pollard, C. and Sag, I. 1994. *Head-driven Phrase Structure Grammar*. Stanford/Chicago: CSLI Publications and University of Chicago Press.
- Reape, M. 1994. Domain Union and Word Order Variation in German. In J. Nerbonne, K. Netter and C. Pollard (eds.), *German in HPSG*, pages 151–197, Stanford: CSLI Publications.
- Soehn, P. and Sailer, M. 2003. At first blush on tenterhooks: About selectional restrictions imposed by nonheads. In G. Jaeger, P. Monachesi, G. Penn and S. Wintner (eds.), *Proceedings of the Formal Grammar conference 2003.*, pages 149–161.
- Van Eynde, F. 1998. The Immediate Dominance Schemata of HPSG. In P.-A. Coppen, H. van Halteren and L. Teunissen (eds.), *Computational Linguistics in the Netherlands 1997*, pages 119–133, Amsterdam/Atlanta: Rodopi.
- Van Eynde, F. 2003. Prenominals in Dutch. In J.-B. Kim and S. Wechsler (eds.), *On-line Proceedings of HPSG 2002*, pages 333–356, Stanford University: CSLI Publications.
- Van Eynde, F. 2004. Minor Adpositions in Dutch. *Journal of Comparative Germanic Linguistics* 7, 1–58.

# A raising analysis of the Dutch passive

Gertjan van Noord 

University of Groningen

Valia Kordoni 

Saarland University

Proceedings of the 12th International Conference on  
Head-Driven Phrase Structure Grammar

Department of Informatics, University of Lisbon

Stefan Müller (Editor)

2005

Stanford, CA: CSLI Publications

pages 410–426

van Noord, Gertjan & Valia Kordoni. 2005. A raising analysis of the Dutch passive. In Stefan Müller (ed.), *Proceedings of the 12th International Conference on Head-Driven Phrase Structure Grammar, Department of Informatics, University of Lisbon*, 410–426. Stanford, CA: CSLI Publications. DOI: 10.21248/hpsg.2005.24.



## Abstract

This paper focuses on passive constructions in Dutch. Specifically, we focus on *worden*, as well as *krijgen* passives in Dutch, for which we propose a uniform, raising analysis in HPSG. We also show that such an analysis can be carried over to account for passives cross-linguistically. Specifically, we look at corresponding structures in German and show that there is no need for a dual raising and control analysis for the German “agentive” (*werden*) and the German “dative” (*kriegen*) passives, respectively, as has been proposed in Müller (2002) and Müller (2003).

## 1 Introduction

As an introductory general explanatory note to the Dutch data we will be looking at in the following, we need to point out here that Dutch distinguishes between nominative and non-nominative personal pronouns and exhibits no morphological distinction between indirect and direct objects. As far as word order in Dutch ditransitives that we are interested in here is concerned, indirect objects precede direct objects.

The following are examples of the main passives in Dutch.<sup>1,2</sup>

- (1) a. Peter kust haar.  
Peter.subj kisses her.obj1  
“Peter kisses her.”  
b. Zij wordt gekust (door Peter).  
she.subj is kissed (by Peter)  
“She is kissed (by Peter).”
- (2) Het raam is geopend.  
the window.subj is opened  
“The window is open.”

There are also impersonal passives in Dutch:<sup>3</sup>

- (3) a. Peter danst in Amsterdam.  
Peter.subj dances in Amsterdam  
“Peter is dancing in Amsterdam.”  
b. In Amsterdam wordt gedanst.  
In Amsterdam is danced  
“There is dancing in Amsterdam.”
- (4) a. Peter arriveert in Amsterdam.  
Peter.subj arrives in Amsterdam  
“Peter arrives in Amsterdam.”  
b. \*In Amsterdam wordt gearriveerd.  
In Amsterdam is arrived  
“There is arriving in Amsterdam.”

---

<sup>1</sup>The *zijn* (“stative”) passives in (2) above are beyond the scope of this paper.

<sup>2</sup>In the glosses subj = subject, obj1 = object1 (*primary object*), obj2 = object2 (*secondary object*).

<sup>3</sup>Impersonal passives are also beyond the scope of this paper.

Finally, Dutch also exhibits a special kind of passives which are formed with the auxiliary *krijgen* (“to get”; henceforth, *krijgen* passive). The *krijgen* passive is formed from ditransitive verbs in Dutch, which subcategorise for a *primary* (obj1) and a *secondary* (obj2) object. The *secondary* object of the ditransitive verb surfaces as the subject of the *krijgen* passive:

- (5) a. Ik stuur hem het boek toe.  
I.subj send him.obj2 the book.obj1 to  
“I send him the book.”  
b. Hij krijgt het boek toegestuurd.  
he.subj gets the book.obj1 sent-to  
“He gets the book sent.”
- (6) a. We betalen hem zijn salaris door.  
we.subj pay him.obj2 his wages.obj1 through  
“We continue to pay him his wages.”  
b. Hij krijgt zijn salaris doorbetaald.  
he.subj gets his wages.obj1 paid-through  
“He is being paid his wages.”

In contrast, when the *primary* object of the ditransitive verb surfaces as the subject of the passive form of Dutch ditransitives, like the one in (5a), for instance, then this passive is formed with the auxiliary *worden*, like the passive form of regular transitive verbs in Dutch (see example (1) above):

- (7) a. Ik stuur hem het boek toe.  
I.subj send him.obj2 the book.obj1 to  
“I send him the book.”  
b. Het boek wordt hem toegestuurd.  
the book.subj is him.obj2 sent-to  
“The book is sent to him.”  
c. \*Hij wordt het boek toegestuurd.  
he.subj is the book.obj1 sent-to  
“He is sent the book.”

As can be observed in examples (5) and (6) above, the *primary* objects of the active forms in (5a) and (6a) (*het boek* and *zijn salaris*, respectively) retain their grammatical function (obj1) in the passive sentences in (5b) and (6b). Actually, the absence of the *primary* object of the ditransitive active form from the corresponding *krijgen* passive renders the latter ungrammatical:

- (8) \*Hij krijgt toegestuurd.  
he.subj gets sent-to  
“\*He was sent.”

## 2 Some interesting exceptions

An exception in the passive patterns in Dutch presented in section 1 is observed with the verb *betalen* (to pay) and its derivatives (*doorbetalen* (to continue payment), *uitbetalen* (to pay out), *terugbetalen* (to pay back), etc).

As shown from examples (7a)–(7c) above, in general *secondary* objects (obj2s) in Dutch ditransitives can never passivise with the auxiliary *worden*. That is, the *secondary* object of Dutch ditransitives, like *geven* and *betalen*, can never surface as the subject of a *worden* passive:

- (9) \*Hij wordt het boek gegeven.  
 he.subj is the book.obj1 given  
 “He is given the book.”
- (10) \*Hij wordt zijn salaris doorbetaald.  
 he.subj is his wages.obj1 paid-through  
 “He is being paid his wages.”

An exception to this pattern is observed in structures like the one in example (11) below. Moreover, when in active sentences headed by the verb *betalen* (to pay) the *primary* object (obj1) is not phonologically realised, then *krijgen* passive structures are also possible (see example (11b) below), in contrast to the behaviour of the rest of the Dutch ditransitives as presented in (8) in the previous section. This last pattern is also to be observed with the verb *uitkeren* (to pay out (benefits); see example (12)).

- (11) a. Hij wordt doorbetaald.  
 he.subj is paid-through  
 “He is being paid.”
- b. Hij krijgt doorbetaald.  
 he.subj gets paid-through  
 “He is getting paid.”
- (12) a. Hij krijgt uitgekeerd.  
 he.subj gets paid-out  
 “He is getting paid out benefits.”
- b. Hij wordt uitgekeerd.  
 he.subj is paid-out  
 “He is being paid out.”

But whereas (11a) and (11b) have the same meaning, (12b) does not entail the same as the sentence in (12a). Specifically, *hij* is the secondary object in (11a), (11b) and (12a), whereas it is the primary object in (12b). We will return to examples (11)–(12) in section 5.

### 3 Cross-linguistic evidence and previous analyses

German also exhibits similar passive structures to the Dutch ones we have presented in section 1. Interesting for our purposes here are the passives of German ditransitives shown in the following examples (from Müller (2003)):

- (13) a. Der Mann hat den Ball dem Jungen geschenkt.  
 the man.nom has the ball.acc the boy.dat given  
 “The man gave the ball to the boy.”

- b. Der Ball wurde dem Jungen geschenkt.  
 the ball.nom was the boy.dat given  
 “The ball was given to the boy.”
- c. Der Junge bekam/kriegte den Ball geschenkt.  
 the boy.nom got the ball.acc given  
 “The boy got the ball as a present.”

Müller (2002), adapting Heinz and Matiasek (1994)’s account of, among others, passivisation in German, proposes a raising analysis for the German *werden* passives (see example (13b) above) and a control-like analysis for the German *bekommen/kriegen* passives, like the one in example (13c) above. The lexical entry for the auxiliary *bekommen* in (14) below is (slightly modified) from (Müller, 2002, p. 149) and captures the gist of his analysis for the dative *bekommen/kriegen* passives in German.

(14) *bekomm-* (dative passive auxiliary)

$$\left[ \begin{array}{l} \text{DA} \langle \boxed{1} \rangle \\ \text{SUBCAT} \langle \boxed{1} \text{ NP } [str] \boxed{2} \rangle \oplus \boxed{3} \oplus \boxed{4} \\ \text{XCOMP} \langle \text{V} \left[ \begin{array}{l} \text{PPP} \\ \text{LEX} \\ \text{SUBCAT} \langle \boxed{3} \oplus \langle \text{NP } [dat] \boxed{2} \rangle \oplus \boxed{4} \rangle \\ \text{XCOMP} \langle \rangle \end{array} \right] + \end{array} \right] \rangle \end{array} \right]$$

Before looking in detail at the analysis proposed in (14), we need to note that in general, in Müller (2002)’s work, subjects are treated differently, as indicated in the following:

- In the subcat list, the first element with structural case is assigned nominative, while the rest of the elements accusative (cf. also Przepiórkowski (1999), Meurers (1999), Meurers (2000)).
- As far as infinitives are concerned, a lexical rule moves subjects from the subcat to the subj list.
- Finally, the feature DA (Designated Argument) represents a complement with subject properties and is introduced in order to distinguish unergatives and unaccusatives.

The control-like part of the account Müller (2002) proposes in (14) lies on the subject of the dative passive auxiliary being coindexed with the dative element of the embedded participle. As mentioned in (Müller, 2002, p. 149) “all elements from the SUBCAT list of the embedded verb are raised to the SUBCAT list of *bekommen* except for the dative object”.

The analysis in (14) above for the German *bekommen/kriegen* passives is somewhat surprising given the fact that passive structures in German headed by *bekommen/kriegen* do not entail that somebody gets something, as the following examples from (Müller, 2002, p. 132) also aim at showing:

- (15) Er bekam zwei Zähne ausgeschlagen.  
 he got two teeth PART(out).knocked  
 “He got two teeth knocked out.”
- (16) a. Der Bub bekommt/kriegt das Spielzeug weggenommen.  
 the lad gets the toy PART(away).taken  
 “The boy has the toy taken away from him.”  
 b. Der Mann bekommt/kriegt das Fahren verboten.  
 the man gets the driving forbidden  
 “The man is forbidden to drive.”  
 c. Der Betrunkene bekam/kriegte die Fahrerlaubnis entzogen.  
 the drunk got the driving allowance withdrawn  
 “The drunk had his driving license taken away.”

As (Müller, 2002, p. 132) also proposes “the meaning of *bekommen* and *kriegen* is bleached in these constructions. Therefore it is not justified to assume that the subject in such dative passive constructions is a receiver and gets a thematic role from *bekommen/erhalten/kriegen*”. In other words, Müller (2002) also disfavors a control analysis for the German *bekommen/kriegen* “dative” passives.

The only reason imposing an analysis like the one presented in (14) we can think of is the realistic technical difficulty to have the lexically case marked dative secondary object (NP [*dat*]) of the SUBCAT list of the passive participle getting raised to the subject NP of the auxiliary *bekommen/kriegen*, which should bear a structural nominative case. Thus, the analysis in (14) only denotes an index sharing between the structurally case marked subject NP of the auxiliary *bekommen/kriegen* and the lexically case marked secondary object NP of the passive participle, in the spirit of a control analysis, instead of an entire synsem object sharing between these two NPs, which would have been expected under a raising analysis, as would have also, apparently, been favored by Müller (2002).

The analysis discussed above is faithful to the insights of the passivisation analyses proposed in Kathol (1994) and Pollard (1994), which, thus, face the same problems as the ones mentioned above in relation to the analysis of Müller (2002).

Specifically, Kathol (1994), following Hinrichs and Nakazawa (1989)’s approach to auxiliaries in German, proposes in short that passive auxiliaries in German can not only “absorb” the argument structure of their verbal complements, but also choose to raise only a subset of this argument structure, or to realise certain complements in a different way.

This is captured in the lexical entry for the auxiliary *werden*, proposed in (Kathol, 1994, p. 246):

- (17) *werden*
- $$\left[ \begin{array}{l} \text{SUBJ} \quad \langle \text{NP}[\text{nom}]_{\boxed{1}} \rangle \\ \text{COMPS} \quad \boxed{2} \& \langle \text{V} \left[ \begin{array}{l} \text{VFORM} \quad \text{part ii} \\ \text{SUBJ} \quad \langle \text{NP} \rangle \\ \text{COMPS} \quad \langle \text{NP}[\text{acc}]_{\boxed{1}} \rangle \& \boxed{2} \end{array} \right] \rangle \end{array} \right]$$

In (17) above what is promoted to subject is not the entire NP, but only its index specification. To quote (Kathol, 1994, p. 246):

“Since indices do not contain a specification for CASE, they can belong to NPs with *different* case values without giving rise to conflict. Structure-sharing among indices then ensures that the case alternation does not affect the part of the linguistic information that remains constant, namely the role the argument plays in semantic interpretation.”

In the same spirit the following entry for the auxiliary *bekommen* below aims at capturing the gist of Kathol’s analysis for the German dative *bekommen/kriegen* passives.

(18) *bekommen* (Kathol, 1994, p. 246)

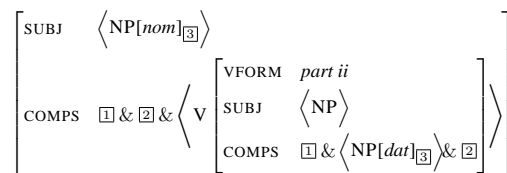

Finally, Pollard (1994)’s analysis of the German *bekommen/kriegen* passives is very similar to that of Kathol (1994) briefly presented above and is captured in the following lexical entry for the passive auxiliary *bekommen*:

(19) passive auxiliary *bekommen* (Pollard, 1994, p. 291)

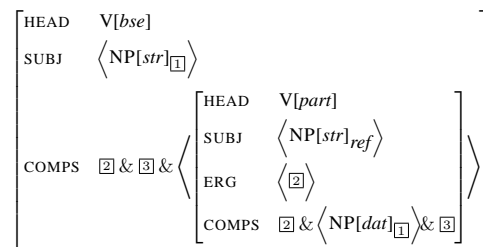

Thus, in Pollard (1994)’s analysis the NP[*dat*] is not attracted, but is coindexed with the matrix subject.

This fact does not only point even more clearly to a control, rather than a raising analysis, but is in general the common background which underlies all the three analyses of Müller (2002), Kathol (1994) and Pollard (1994) presented in the previous.

An additional problem shared among Müller (2002), Kathol (1994) and Pollard (1994) lies in the fact that in their analyses it is in a way or another assumed that the nominative case on the value of the SUBJ feature is redundant as the value of SUBJ needs a finite realisation context (i.e., a finite auxiliary) which is associated with nominative case assignment. In situations, though, where the subject is realised



with a different case specification, this actually leads to a complication in the analysis because the case specification has to be changed back into *accusative*. Thus, examples like the following in Dutch cannot be accounted for by the accounts of Müller (2002), Kathol (1994) and Pollard (1994):

- (20) Ik zie hem gekust worden.  
 I.nom see him.acc kissed be  
 “I see him being kissed.”
- (21) Ik zie hem het boek toegestuurd krijgen.  
 I.nom see him.acc the book PART-sent get  
 “I see that he gets the book sent to him.”

#### 4 Motivation for a raising analysis of passives in Dutch

The analysis we propose and formalise in the next section for the Dutch passives we have presented in section 1 is a uniform raising analysis. The motivation in favour of such an analysis, especially for the *krijgen* passives, in contrast to a control analysis like the one proposed, among others, in (14) in section 3, is based on the general treatment of raising and control phenomena, as also presented in Pollard and Sag (1994).

Specifically, following Jacobson (1990), (Pollard and Sag, 1994, p. 141) show that whereas equi verbs allow NPs (or PPs) instead of their VP complement, this is never true for raising verbs (the examples are from (Pollard and Sag, 1994, pp. 141–142)):

- (22) Leslie tried/attempted/wants something/it/to win.  
 (23) \*Whitney seems/happens something/it.

Such contrasts between equi and raising verbs, (Pollard and Sag, 1994, p. 142) comment, “follow directly from the Raising Principle.<sup>4</sup> Since the raising verbs in (23) assign no semantic role to their subject argument, there must be an unsaturated complement on the same SUBCAT list. But NPs like *something* or *it* are saturated, and hence the SUBCAT list required for examples like those in (23) is systematically excluded.”

*krijgen*-headed structures in Dutch behave in a similar way to raising structures like the one in example (23) above:

- (24) ?Hij krijgt het boek toegestuurd en zijn buurman krijgt dat ook.  
 he gets the book sent and his neighbour gets that too  
 “\*He is sent the book and his neighbour is that too.”
- (25) \*Hij krijgt uitbetaald en Piet krijgt dat ook.  
 he gets paid and Peter gets that too  
 “\*He gets paid and Peter gets that too.”

<sup>4</sup>Raising Principle (Pollard and Sag, 1994, p. 140): Let E be a lexical entry whose SUBCAT list L contains an element X not specified as expletive. Then X is lexically assigned no semantic role in the content of E if and only if L also contains a (nonsubject) Y  $\left[ \text{SUBCAT } \langle X \rangle \right]$ .

- (26) a. \*Uitbetalen bij ziekte? Nee, dat krijg ik niet.  
 PART-pay in case of illness? No, that get I not  
 “To pay in case of illness? No, that I don’t get.”
- b. \*Mij uitbetalen bij ziekte? Nee, dat krijg ik niet.  
 me PART-pay in case of illness? No, that get I not  
 “To pay me in case of illness? No, that I don’t get.”

Moreover, *krijgen*-headed passive structures, like the ones in the examples above, behave in a similar way to regular raising structures in Dutch, as we show in the following:

- (27) a. \*Het probeert te regenen.  
 it tries to rain  
 “It tries to rain.”
- b. Het schijnt te regenen.  
 it seems to rain  
 “It seems to rain.”
- (28) a. Ik probeer te winnen en mijn tegenstander probeert dat ook.  
 I try to win and my opponent tries that too  
 “I try to win and so does my opponent”.
- b. \*Ik schijn te winnen en mijn tegenstander schijnt dat ook.  
 I seem to win and my opponent seems it too  
 “I seem to win and so does my opponent.”
- (29) a. De wedstrijd winnen? Ja, dat probeer ik.  
 the match win? yes, that try I  
 “To win the match? Yes, that is what I try.”
- b. \*De wedstrijd winnen? Ja, dat schijn ik.  
 the match win? yes, that seem I  
 “To win the match? Yes, that is what I seem.”

For completeness, we should underline here that Dutch regular passive constructions, i.e., constructions headed by the auxiliary *worden*, also conform to regular raising structures in Dutch, like the ones in (27a)-(29b) above:

- (30) \*Ik werd door hem geslagen en zij werd dat ook.  
 I was by him beaten and she was that too  
 “I was beaten by him and she was too.”
- (31) a. \*Kussen? Nee, dat werd ik nog nooit.  
 kiss? no, that was I yet never  
 “To kiss? No, I have never been that.”
- b. \*Mij kussen? Nee, dat werd ik nog nooit.  
 me kiss? no, that was I yet never  
 “To kiss me? No, I have never been that.”

The raising analysis we propose for the Dutch constructions at hand, especially for the *krijgen* passives, finds more supporting evidence in data like the following:

- (32) De volgende heette ook Sjef - drugsverslaafd, acht keer achtereen opgenomen  
 the next one was-called also Sjef - drug-addicted, eight times placed  
 in een afkickcentrum en twee keer een sociale woning toegewezen gekregen en weer  
 in a detox-center and twice a social-security house assigned got and again  
 afgenomen.  
 taken-away  
 “The next one was also called Sjef - a drug addict, has been placed eight times in a detox  
 center, and a social security house has been assigned to him and taken away from him twice.”
- (33) En nu krijgen wij het probleem onder de neus gewreven.  
 and now get we the problem under our nose pushed  
 “And now we are presented with the problem.”
- (34) Niet alleen het kind dat dit boek krijgt voorgelezen, voelt zijn oprechte optimisme  
 not only the child who this book gets PART.read, feels his sincere optimism  
 bevestigd.  
 acknowledged  
 “Not only the child to whom one reads this book will feel that his sincere optimism is ac-  
 knowledged.”

The examples (32)-(34) illustrate the use of the *krijgen* passive with a subject that does not appear to bear the semantic role of “receiver”.

Consequently, the subjects of the aforementioned sentences are not arguments introduced by the auxiliary *krijgen*, but elements of the SUBCAT list of the embedded past participles (*afgenomen*, *gewreven*, *voorgelezen*), which are raised to the subject function of the structures in (32)-(34).

The object-to-subject raising analysis for the Dutch *krijgen* passives we propose here is at odds in spirit with analyses of the corresponding *kriegen/bekommen* passives in German, like the ones of Haider (1984) and Haider (1985), which propose that the German *kriegen/bekommen* passives may look like ordinary passive or raising constructions, but are not, and, consequently, that the subject of the passive auxiliary in sentences like the following

- (35) ...dass er ein Buch geschenkt kriegte  
 ...that he.nom a book.acc presented got  
 “...that he got a book as a present” (Haider, 1985, p. 98)

is an argument of the higher verb, *kriegen*, rather than of the lower passive participle. The idea in these analyses is that the recipient passive construction works something like the parallel English construction with *get* and *have* as the higher verb

- (36) Pat got/had [three papers accepted].

in which the subject *Pat* is not an argument of *accept* because of the ungrammaticality of what would be the source sentence:

- (37) \*They accepted Pat three papers.

We will not argue here against the essence of Haider’s analysis as far as the German *kriegen/bekommen* passives are concerned. For this we are referring the reader to Müller (2002).

We would like, though, to underline that the main idea of Haider’s analysis, which suggests that the subject of the passive auxiliary in the parallel German construction with *kriegen* and *bekommen* is an argument of the higher verb, cannot be considered to hold in the case of the Dutch *krijgen* passive that we are focusing on here. Sentences like the following

- (38) a. Zij wierpen hem de oplossing in de schoot.  
 they.subj threw him.obj2 the solution.obj1 in the lap  
 “They made the solution very easy for him.”  
 b. \*Zij wierpen de oplossing in de schoot.  
 they.subj threw the solution.obj1 in the lap  
 “They made the solution very easy.”  
 c. Hij krijgt de oplossing in de schoot geworpen.  
 he.subj gets the solution.obj1 in the lap thrown  
 “He is offered the solution very easily.”

indicate that *hij* in (38c) is indeed an object (the secondary object (obj2)) of *werven* (which has been raised to subject) and which is obligatory, as the ungrammaticality of the sentence in (38b) indicates (for the intended meaning). Therefore, in (38c) it must be *hij* that fulfills the requirement that the embedded passive participle has a secondary object (obj2).

Finally, we argue here that it is also wrong to assume, as Haider (1986), Heinz and Matiasek (1994) and Kathol (2000) do for the parallel German passive constructions with *kriegen* and *bekommen*, that both *krijgen* and the embedded participle assign the semantic role of “theme” to the accusative primary object (obj1) of the Dutch *krijgen* passives. Consequently, as we show, and similarly to our treatment of the subject of the Dutch *krijgen* passives that we have presented above, the primary accusative objects of the constructions at hand are not selected by *krijgen*, either.

Specifically, as we have already shown in (11b), for instance, in section 2, repeated here for convenience

- (39) Hij krijgt doorbetaald.  
 he.subj gets paid-through  
 “He is getting paid.”

there are *krijgen* passive structures in Dutch where the accusative primary object (obj1) is not even phonologically realised.

Moreover, in amalgamated combinations of Dutch ditransitives with somewhat more predicted/*fixed* primary objects, such non-functionally controlled obj1s may also be realised as primary objects of the corresponding passives headed by *krijgen*:

- (40) a. ... dat hij mij een rad voor ogen draait  
 ... that he.subj me.obj2 a wheel.obj1 in-front-of eyes rotates  
 “... that he is misleading me”

- b. ... dat ik een rad voor ogen krijg gedraaid
- (41) a. ... dat ik hem de huid volscheld  
 ... dat I.subj him.obj2 the skin.obj1 spray  
 “... that I yell bad things at him / that I curse at him”  
 b. ... dat hij de huid krijgt volgescholden
- (42) a. ... dat ik hem een hart onder de riem steek  
 ... dat I.subj him.obj2 a heart.obj1 under the belt put  
 “... that I give him hope”  
 b. ... dat hij een hart onder de riem krijgt gestoken
- (43) a. ... dat ik hem zand in de ogen strooi  
 ... that I.subj him.obj2 sand.obj1 in the eyes pour  
 “... that I mislead him”  
 b. ... dat hij zand in de ogen krijgt gestrooid
- (44) a. ... dat ik hem de duimschroeven aandraai  
 ... that I.subj him.obj2 the screws.obj1 tighten-up  
 “... that I put him under pressure”  
 b. ... dat hij de duimschroeven krijgt aangedraaid

In conclusion, based on the behaviour of *krijgen* in relation to the subject and the primary object of the Dutch passive constructions it heads that we have shown above we propose that the *passive krijgen* should be treated as a true auxiliary.

## 5 Formalisation of the analysis

Based on the motivation presented in section 4, we formalise our analysis for the Dutch *worden* passive in the lexical entry in (45) below and our analysis for the Dutch *krijgen* passive in the lexical entry in (46) below. Both lexical entries use the function *raise\_to\_subject()* (Figure 1).<sup>5</sup>

This function takes a noun synsem, and preserves all values in the output, except for the CASE value, which is set to *nominative* or *accusative*.

As aimed at and expected, in both lexical entries below all the elements of the SUBCAT list of the embedded participle are raised to the SUBCAT list of *worden* and *krijgen*, respectively. In the case of *worden*, the accusative primary object of the embedded participle surfaces as the nominative subject of the auxiliary after raising. In the case of *krijgen*, it is the dative secondary object which surfaces as the nominative subject of the auxiliary after raising.<sup>6</sup>

<sup>5</sup>There are other ways in which the same effect can be obtained in a formalism. We chose a function because it is compact and easy to understand. Specifically, the function *raise\_to\_subject()* (Figure 1) is really only an abbreviatory device, since it only consists of simple unifications. The same effect could be obtained, more verbosely, without functions.

<sup>6</sup>In our analysis, primary objects (obj1) bear accusative case, and secondary objects (obj2) dative case.

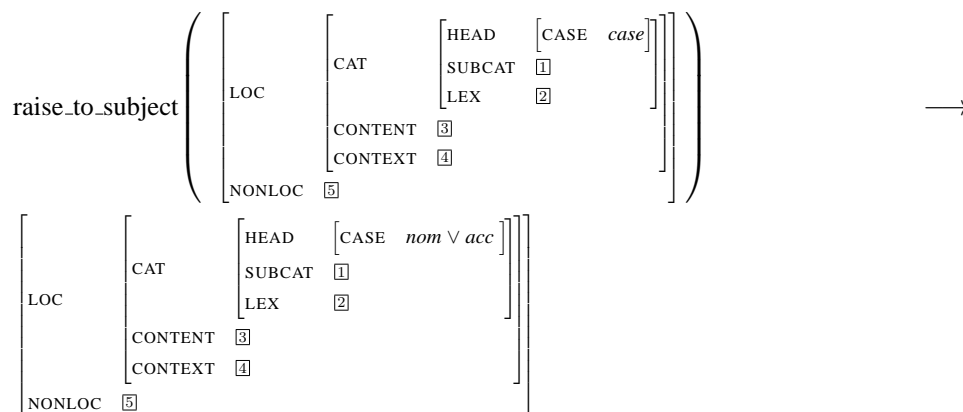
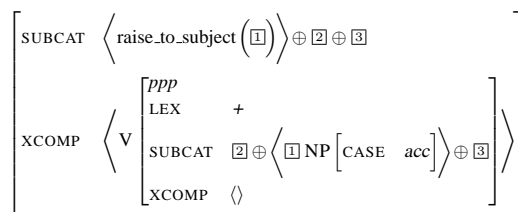
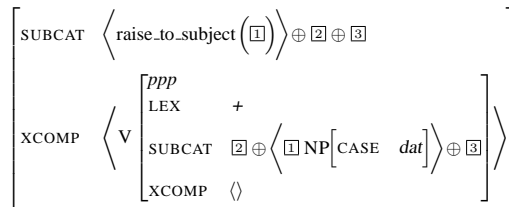

Figure 1: Definition of the function `raise_to_subject()`

(45) *worden* (passive auxiliary)



(46) *krijgen* (dative passive auxiliary)



The lexical entry in (45) accounts for the examples in (1b) and (7b) in section 1. In the case of example (1b) the value of  $\textcircled{2}$  in (45) is the empty list, since the verb *kussen* (to kiss) is transitive, and not ditransitive.  $\textcircled{3}$  may contain a PP denoting the logical subject (*door Peter* in example (1b)).

The lexical entry in (46) accounts for the examples in (5b) and (6b) in section 1, where the ditransitive verbs have a primary object. For most ditransitive verbs, the primary object is compulsory, while for *uitkeren* and the *betalen*-family, it is optional. Example (8) demonstrates the former: the primary object is missing, while in (5b) and (6b) it is present (i.e.  $\textcircled{2}$  in (46) is a list containing the primary object). In examples (11b) and (12a) on the other hand,  $\textcircled{2}$  is the empty list: the primary object is absent.

This variation is a lexical property of the verbs, and not limited to the passive mood, as the following examples show.

(47) \*Ik stuur hem toe.  
I.subj send him.obj2 to

“\*I send him.”

(48) We betalen hem door.  
we.subj pay him.obj2 through  
“We continue to pay him.”

(49) Ze keren het uit.  
they.subj pay it. out  
“They pay it out benefits.”

(47) is (5) without (compulsory) primary object, (48) (6a) without (optional) primary object, and (49) (12) also without (optional) primary object.

As far as example (11) is concerned, we assume that the verb *betalen* (to pay), as well as its derivatives *doorbetalen*, *uitbetalen*, *terugbetalen*, etc., may also have a purely transitive use:

(50) a. Ik betaal de tuinman.  
I.subj pay the gardener.obj1  
b. De tuinman wordt betaald.  
the gardener.subj is paid

In such cases, the sole object of the active form of the *betalen*-family verbs is considered to be their primary object, which may, therefore, be accounted for by the auxiliary *worden* in (45). Then the value of [2] in (45) is the empty list, since the verb *betalen* (to pay) is considered to function as transitive, and not ditransitive.

Finally, the analysis we propose here can also account straightforwardly for the structures in (20) and (21) of section (3), repeated here for convenience:

(51) Ik zie hem gekust worden.  
I.nom see him.acc kissed be  
“I see him being kissed.”  
(52) Ik zie hem het boek toegestuurd krijgen.  
I.nom see him.acc the book PART-sent get  
“I see that he gets the book sent to him.”

## 6 Conclusion

We have motivated and formalised a uniform raising analysis for the *worden* and *krijgen* passives in Dutch. The analysis accounts for the Dutch data presented in section 1, without needing to find refuge to ad hoc theoretical and technical resorts, like the analysis of Müller (2002) (cf., the control-like analysis of the German *bekommen/kriegen* passives), as presented in section 3. The formalisation of the analysis in section 5 is essentially based on the fact that the information shared in raising constructions may leave out some paths from the SYNSEM information, while still remaining a raising analysis. In the case at hand, the SYNSEM value of the primary object of the embedded participle of the *worden* passive, as well as the SYNSEM value of the secondary object of the embedded participle of the *krijgen* passive, are raised to the subject of their respective auxiliaries, with only their CASE value changing to the (nominative or accusative) case required by the

subject. Such a formalisation does not only account in a straightforward way for the behaviour of the Dutch data at hand (see section 1), but it can also offer a solution to the analysis presented in (14) in section 3 for the German *bekommen/kriegen* passives. Finally, such a formalisation also amends naturally the shortcomings of the intended raising analyses of German passives proposed in Kathol (1994) and Pollard (1994), which suggest that what should be raised to the subject of the *werden* and *bekommen/kriegen* passives is not the entire argument NP, but only its INDEX specification, since indices do not contain a specification for CASE, and they can, thus, belong to NPs with *different* case values without giving rise to a conflict. But as was also mentioned in section 3, structure-sharing only among indices points to a control analysis of passivisation in German. Thus, our analysis, which formally captures the fact that passivisation is based on structure-sharing of entire synsem objects, is the most straightforward analysis.

## 7 Outlook: open issues

The analysis for the Dutch passives we have presented in section 5 accounts, as we have shown, straightforwardly for structures like the following:

- (53) Hij krijgt het boek opgestuurd.  
 he.subj gets the book.obj1 PART-sent  
 “He gets the book sent to him.”
- (54) Hij krijgt uitbetaald.  
 he.subj gets PART-paid  
 “He gets paid’.”

Such an account, though, fails to make predictions for structures like the one in (55a), where the passive structure is headed by *worden*, instead of the expected *krijgen*, as is shown in (55b):

- (55) a. Kleine kinderen moeten worden voorgelezen.  
 small children.subj must be PART-read  
 “Small children must be read to.”
- b. Dan krijgen ze voorgelezen uit krant of tijdschrift.  
 then get they.subj PART-read from newspaper or journal  
 “Then they get read to from newspaper or journal.”

The analysis we have proposed in section 5 also fails to make predictions for structures like the ones in (56a) and (57a), in which the secondary (indirect) objects (obj2s) are raised to the subject of the passive structures headed in both cases by *worden*. The predicted structures are the ones in (56b) and (57b), respectively.

- (56) a. Reizigers worden verzocht uit te stappen.  
 passengers.subj are requested PART to step  
 “Passengers are requested to leave.”



- b. Reizigers wordt verzocht uit te stappen.  
 passengers.obj2 is requested PART to step  
 “One is requesting the passengers to leave.”
- (57) a. Een tijd geleden werd hij gevraagd te koken voor Tony Blair.  
 a while ago was he.subj asked to cook for Tony Blair  
 “A while ago he was asked to cook for Tony Blair.”
- b. Twee maanden geleden werd hem gevraagd terug te komen.  
 two months ago was him.obj2 asked PART to come  
 “He was asked two months ago to come back.”

Structures like the ones in (56a) and (57a), for instance, show that unergatives in Dutch in which the direct object is not phonologically realised tend to treat the indirect object of their subcat list as a direct one at the process of passivisation. This tendency is yet to be accounted for.

## References

- Haider, Hubert. 1984. Mona Lisa lächelt stumm – Über das sogenannte deutsche “Rezipientenpassiv”. *Linguistische Berichte* 89, 32–42.
- Haider, Hubert. 1985. The Case of German. In Jindrich Toman (ed.), *Studies in German Grammar*, pages 65–101, Dordrecht: Foris.
- Haider, Hubert. 1986. Fehlende Argumente: vom Passiv zu kohärenten Infinitiven. *Linguistische Berichte* 101, 3–33.
- Heinz, Wolfgang and Matiasek, Johannes. 1994. Argument structure and case assignment in German. In John Nerbonne, Klaus Netter and Carl Pollard (eds.), *German in Head-Driven Phrase Structure Grammar*, pages 199–236, CSLI Publications, no. 46 in CSLI Lecture Notes.
- Hinrichs, Erhard and Nakazawa, Tsuneko. 1989. Subcategorization and VP Structure in German. Proceedings of the Third Symposium on Germanic Linguistics.
- Jacobson, Pauline. 1990. Raising as Function Composition. *Linguistics and Philosophy* 13, 423–475.
- Kathol, Andreas. 1994. Passives without Lexical Rules. In John Nerbonne, Klaus Netter and Carl Pollard (eds.), *German in Head-Driven Phrase Structure Grammar*, pages 237–272, CSLI Publications, no. 46 in CSLI Lecture Notes.
- Kathol, Andreas. 2000. *Linear Syntax*. New York, Oxford: Oxford University Press.
- Meurers, Detmar. 1999. Raising spirits (and assigning them case). In *Groninger Arbeiten zur Germanistischen Linguistik (GAGL)*, volume 43, pages 173–226.

- Meurers, Detmar. 2000. *Lexical generalizations in the syntax of German non-finite constructions*. Arbeitspapiere des SFB 340, No. 145, Tübingen: Eberhard-Karls-Universität.
- Müller, Stefan. 2002. *Complex Predicates: Verbal Complexes, Resultative Constructions, and Particle Verbs in German*. Studies in Constraint-Based Lexicalism, No. 13, Stanford: Center for the Study of Language and Information.
- Müller, Stefan. 2003. Object-To-Subject-Raising and Lexical Rule: An Analysis of the German Passive. In Stefan Müller (ed.), *Proceedings of the HPSG-2003 Conference, Michigan State University, East Lansing*, pages 278–297, CSLI Publications.
- Pollard, Carl. 1994. Toward a Unified Account of Passive in German. In John Nerbonne, Klaus Netter and Carl Pollard (eds.), *German in Head-Driven Phrase Structure Grammar*, pages 273–296, CSLI Publications, no. 46 in CSLI Lecture Notes.
- Pollard, Carl and Sag, Ivan A. 1994. *Head-Driven Phrase Structure Grammar*. University of Chicago Press.
- Przepiórkowski, Adam. 1999. On case assignment and "adjuncts as complements". In Gert Webelhuth, Jean-Pierre Koenig and Andreas Kathol (eds.), *Lexical and Constructional Aspects of Linguistic Explanation*, pages 231–245, CSLI Publications, No. 1 in Constraint-Based Lexicalism.

# An HPSG account of closest conjunct agreement in NP coordination in Portuguese

Aline Villavicencio 

Universidade Federal do Rio Grande do Sul, Brazil

Louisa Sadler 

University of Essex

Doug Arnold 

University of Essex

Proceedings of the 12th International Conference on  
Head-Driven Phrase Structure Grammar

Department of Informatics, University of Lisbon

Stefan Müller (Editor)

2005

Stanford, CA: CSLI Publications

pages 427–447

Villavicencio, Aline, Louisa Sadler & Doug Arnold. 2005. An HPSG account of closest conjunct agreement in NP coordination in Portuguese. In Stefan Müller (ed.), *Proceedings of the 12th International Conference on Head-Driven Phrase Structure Grammar, Department of Informatics, University of Lisbon*, 427–447. Stanford, CA: CSLI Publications. DOI: 10.21248/hpsg.2005.25. 

## Abstract

This paper discusses the NP-internal agreement strategies observed in an empirical (corpus based) study of Portuguese, and proposes an analysis which is formalized in the framework of Head-Driven Phrase Structure Grammar (HPSG). The empirical study suggests that what were previously thought to be rare or non-existent strategies occur with surprising frequency. Capturing these strategies poses problems for many standard approaches to agreement. The formalization shows how they can be captured with a relatively conservative extension of the existing HPSG theory of agreement.

## 1 Introduction

This paper discusses the NP-internal agreement strategies observed in an on-going empirical study of Portuguese, and proposes an analysis which is formalized in the framework of Head-Driven Phrase Structure Grammar (HPSG). In particular, we focus on the behaviour of determiners and attributive adjectives which modify coordinate structures, such as can be seen in (1). As will appear, the agreement strategies observed pose a challenge for most existing approaches to coordination and agreement.

- (1) *Esta canção anima os corações e mentes brasileiras.*  
This song animate the.MPL hearts.MPL and minds.FPL Brazilian.FPL  
'This song animates Brazilian hearts and minds'

The paper is structured as follows. Section 2 provides some background on the way agreement is handled in HPSG, including some brief references to the literature. Section 3 describes the different agreement strategies that appear to be employed in Portuguese in relation to coordinated nouns and NPs. We will suggest that, in addition to the widely attested 'resolution' agreement strategy, Portuguese also uses a crosslinguistically less familiar (but still widely attested) 'closest conjunct' agreement strategy for NP internal agreement. Perhaps more surprisingly, we will suggest that Portuguese also permits 'mixed' strategies, for example, using one strategy for prenominal dependents and another for postnominal dependents, in the same NP (in fact, this possibility is exemplified in (1)), and even allowing the use of one strategy for number with another for gender. In Section 4 we will present corpus data which show that these 'alternative' strategies are more widespread than has been generally assumed. Section 5 presents the HPSG formalization: the central idea will be that three kinds of agreement information must be recorded — information about the leftmost and rightmost conjuncts, as well as information

---

<sup>†</sup>We have benefitted from discussion with many people, but special thanks are due to Mary Dalrymple, Irina Nikolaeva, and participants at the HPSG 2005 Conference in Lisbon. Remaining unclarity and errors are purely our fault, of course.

This research was supported by the AHRB Project *Noun Phrase Agreement and Coordination*, MRGAN10939/APN17606.

about the coordinate structure as a whole. Section 6 provides a conclusion and notes some open questions.

## 2 Agreement in HPSG

Agreement phenomena have received considerable attention within HPSG since Pollard and Sag (1994) laid the foundations (see, for example, Kathol, 1999; Moosally, 1999; Wechsler and Zlatić, 2001, 2003; Abeillé, 2004; Yatabe, 2004).

Pollard and Sag (1994, Ch2), distinguished two main kinds of agreement: ‘index-based’ agreement, and ‘syntactic’ agreement.<sup>1</sup> A typical instance of syntactic agreement (or ‘concord’) is agreement for case between a noun and a determiner or attributive adjective. One way of modelling this kind of agreement in HPSG is to assume that nouns, determiners, and attributive adjectives carry a feature CONCORD, containing attributes such as CASE and GENDER. NP-internal agreement is then the result of requiring token identity between the CONCORD feature on nouns, determiners and adjectives. Index agreement is more semantic. The idea is that nominal expressions are associated with indices, which correspond roughly to discourse variables — so, for example, a pronoun and its antecedent will share the same index. Indices are taken to be feature structures, specified for attributes like NUMBER, GENDER, and PERSON, whose values relate to the referential/semantic possibilities of the associated nominal. Agreement for person, number, and gender between a pronoun and its antecedent is then an automatic consequence of co-indexation. Subject-verb agreement can be handled by having verbs select subjects with a certain kind of index — for example, a third person singular verb like *walks* will require that its subject’s INDEX be third person and singular.

This provides an account for a wide range of intricate agreement phenomena, including ‘hybrid nouns’ (Corbett, 1991), which can trigger different kinds of agreement on different targets within the same clause. For example, in Spanish the title *Majestad* (‘Majesty’) is feminine, so it triggers feminine agreement on attributive adjectives and determiners. However, if it refers to a male individual, it triggers masculine agreement on a predicative adjective, and requires masculine anaphora:

- (2) *Su Majestad.1 Suprema esta contento. (Éli.1 ...)*  
Pron.FEM Majesty Supreme.FEM is happy.MASC. (He.MASC ...)  
His Supreme Majesty is happy.

This is easily dealt with in this approach, by allowing CONCORD and INDEX values to differ (cf. Kathol, 1999; Wechsler and Zlatić, 2003). As used in an example like

---

<sup>1</sup>Pollard and Sag (1994) also discuss a third kind of agreement, ‘pragmatic’ agreement, which we ignore here. Pragmatic agreement is exemplified by honorific agreement in Korean. The idea is that certain kinds of marking convey background information about social relationships (e.g. between speaker and addressee), and this information must be consistent on expressions which co-occur. Instances of pragmatic agreement failure do not involve violation of grammatical constraints *per se*, so they are infelicitous, rather than strictly ungrammatical.

(2), a partial description of the HEAD value of *Majestad* might be as in (3):

$$(3) \left[ \begin{array}{l} \text{CONCORD} \\ \text{CONTENT | INDEX} \end{array} \left[ \begin{array}{l} \text{PER } 3rd \\ \text{NUM } sg \\ \text{GEN } fem \end{array} \right] \right]$$

That is, it will be CONCORD | GEN *fem*, but (as one would expect, given that its referent is male) INDEX | GEN *masc*. The behaviour of a noun like *Majestad* follows if agreement between a noun and an attributive adjective is concord (syntactic agreement, involving the value of CONCORD) whereas agreement between an NP and a predicative adjective involves the NP's INDEX value.

Though the general approach works well for non-coordinate structures, extending it to coordinate structures raises some interesting problems. In particular, predicting the agreement properties of a coordinate structure from the properties of the individual conjuncts turns out to be non-trivial. In cases where conjuncts differ in some agreement property, two strategies are widely attested crosslinguistically (although not, of course, to the total exclusion of other strategies):

**Syntactic Resolution:** agreement marking on agreement targets is the result of some computation over the properties of (all) the individual conjuncts — e.g. in many languages a coordinate structure will trigger feminine agreement only if all the conjuncts are feminine (e.g. Dalrymple and Kaplan, 2000; Wechsler and Zlatić, 2003);

**Closest Conjunct Agreement:** agreement marking on an agreement target depends on the properties of only one conjunct — the closest one (Corbett, 1991; Moosally, 1998; Sadler, 1999; Moosally, 1999; Sadler, 2003; Yatabe, 2004).

Closest conjunct agreement (CCA, also known as ‘single conjunct’, or ‘partial’ agreement)<sup>2</sup> is quite widespread crosslinguistically, and is found in typologically diverse languages including Romance, Celtic, Semitic and Bantu languages. Most theoretical work to date on these agreement patterns has dealt with closest conjunct predicate-argument agreement (e.g. agreement between a verbal head and its subject and object).

For example, from an HPSG perspective Moosally (1999) proposes an account of single conjunct predicate-argument agreement in Ndebele. Her treatment takes this to be a case of index-agreement, and involves a relation between the INDEX feature of the (coordinate-structure) sign and the INDEX features of the CONJ-DTRS. Moosally's CCA constraint is essentially as in (4):

<sup>2</sup>Strictly speaking, CCA, ‘single conjunct’ and ‘partial’ agreement are different concepts — for example, single conjunct agreement should also cover cases of *furthest* conjunct agreement. However, in fact, most cases of single conjunct agreement are cases of CCA.

$$(4) \left[ \begin{array}{l} \text{SYNSEM} | \text{INDEX} \quad \boxed{1} \\ \text{CONJ-DTRS} \quad \left\langle \dots, \left[ \text{INDEX} \quad \boxed{1} \right] \right\rangle \end{array} \right]$$

This constraint requires the INDEX value of the coordinate structure to be token-identical with that of the final conjunct daughter: agreement between a verbal head and a nominal coordinate structure (subject or object) then proceeds in the normal way. While this seems satisfactory for the Ndebele which Moosally discusses, it is inappropriate in very many languages with closest conjunct agreement, in which some agreement processes can be seen to target the features of a single conjunct, but where there is good evidence that the INDEX of the coordinate structure is resolved. For example, in Welsh, predicate-argument agreement is controlled by the closest conjunct, but other agreement processes access resolved features. Thus, in (5), the predicate *dw* ('be') is first person singular, agreeing with the closest conjunct in the subject *i a Gwenllian*, but the pronominal clitic *ein* is plural, reflecting the resolved number value of the coordinate structure subject, which is overall plural (cf. it denotes a plurality).

- (5) *Dw i a Gwenllian heb gael ein talu.*  
 be.1SG I.1SG and Gwenllian.3SG without get Cl.1PL pay  
 'Gwenllian and I have not been paid' Sadler (2003, (12))

Similarly, in Section 3 we will see cases inside Portuguese NPs where a single coordinate structure controls different agreement properties on different targets.

Yatabe (2004) provides an account of CCA in the context of a more general treatment of unlike categories, in particular, what he calls 'each conjunct' agreement (e.g. the situation where a predicate can occur with a coordinate structure only if it can occur with each of the conjuncts separately).<sup>3</sup> The basic idea is that coordinate structures bear a (*head*) feature ARG<sub>S</sub>, whose value is a list made up of the conjuncts *head* values. Rather than being 're-ified' as actual feature values, agreement properties (and other properties involved in argument selection) are accessed 'as needed' by various relations.

The case Yatabe considers is that of the verb *to be* as it occurs with *there*. Assuming that English verbs never agree directly with their complements, the agreement pattern one sees in examples like *There is/\*are a dog in the garden* vs *There \*is/are dogs in the garden* can be handled by assuming that this use of *be* requires its subject to agree in number with its first complement. Simplifying somewhat, Yatabe's constraint to this effect could be stated as in (6), which states that the NUM value of the subject (*there*) must be the value of the relation *num\_value* applied to the head value of the first complement.

<sup>3</sup>As regards agreement, Yatabe's focus is on predicate-argument agreement, rather than the NP internal concord processes that are our concern here, but the approach could no doubt be extended.

$$(6) \left[ \begin{array}{l} \text{SUBJ} \quad \langle \langle [\text{CAT} | \text{HEAD} | \text{AGR} \quad \text{num\_value}(\boxed{1})] \rangle \rangle \\ \text{COMPS} \quad \langle \langle [\text{HEAD} \quad \boxed{1}], \dots \rangle \rangle \end{array} \right]$$

In the case where the complement is a coordinate structure (*There were two women and a man in the garden*), this would presumably give *there* the number value of the whole coordinate structure *two women and a man* (i.e. ‘resolved’ agreement). To deal with ‘first conjunct agreement’ (i.e. CCA), for cases like *There was a man and two women in the garden*, Yatabe replaces  $\text{num\_value}(\boxed{1})$  in (6) with  $\text{num\_value}(\text{first}(\boxed{1}))$ , where  $\text{first}(\boxed{1})$  is defined so as to return the *head* value of the first conjunct in the case of a coordinate structure (i.e. the first element of ARGS in  $\boxed{1}$ ), and otherwise  $\boxed{1}$  itself. Yatabe does not discuss the sort of data we will present in Section 3, but there is no reason to suppose that additional relations could not be formulated to handle it.

One striking feature of Yatabe’s approach is that, unlike Moosally’s, it does not associate a single agreement value, or set of values, with a coordinate structure. Rather, this use of relations to access agreement properties opens the possibility that different processes might involve different relations, and so simultaneously access different properties. Indeed, it should even be possible for a single relation to operate ‘non-deterministically’ — so that even under one agreement process, a single agreement controller might trigger different agreement on different agreement targets. As will appear, some flexibility of this kind seems to be necessary, but this degree of flexibility may be excessive. Our approach is at once more limited in scope (we deal only with one aspect of coordination — the behaviour of number and gender properties), and more conservative: the formalization we propose in Section 5 will use normal feature percolation principles to associate definite agreement values with coordinate structures; flexibility will be achieved by storing separately information about coordinate structures and (some) individual conjuncts.

### 3 Agreement and Coordination in Portuguese NPs

In non-coordinate structures, Portuguese determiners and adjectives show a simple pattern of concord in number and gender with the nouns they modify:

- (7) *a parede colorida/\*colorido*  
the.FSG wall.FSG coloured.FSG/\*coloured.MSG
- (8) *o teto colorido/\*colorida*  
the.MSG ceiling.MSG coloured.MSG/\*coloured.FSG
- (9) *o teto colorido/\*coloridos*  
the.MSG ceiling.MSG coloured.MSG/\*coloured.MPL



- (10) *a parede colorida/\*coloridas*  
 the.FSG wall.FSG coloured.FSG/\*coloured.FPL

Coordinate structures on the other hand present a much wider range of agreement patterns: since coordinated nouns often jointly control agreement on determiners, adjectives and other dependents within the NP. In fact, as will appear, mixed gender coordinate structures can trigger different agreement patterns on different targets.

We will begin with a discussion of postnominal dependents (APs), and then turn to prenominal determiners and adjectives.

### 3.1 Postnominal APs

Postnominal APs appear to show three distinct patterns of agreement.

Firstly, as regards gender, there is the standard resolution pattern, familiar from many two gender systems, of resolution to masculine if any of the conjuncts is masculine, and to feminine only if all conjuncts are feminine. These examples also illustrate a widely attested pattern of resolution for number, whereby a collection of singular conjuncts yields a plural coordinate structure if the coordinate structure as a whole denotes a plurality.<sup>4</sup>

- (11) *o homem e a mulher modernos*  
 the.MSG man.MSG and the.FSG woman.FSG modern.MPL  
 ‘the modern man and woman’

- (12) *o teto e a parede coloridos*  
 the.MSG ceiling.MSG and the.FSG wall.FSG coloured.MPL  
 ‘the coloured ceiling and wall’

However postnominal APs can also show a second strategy, in which the adjective agrees with the closest (i.e. final) noun in the preceding coordinate phrase:

- (13) *estudos e profissão monástica*  
 studies.MSG and profession.FSG monastic.FSG  
 ‘monastic studies and profession’

- (14) *no povo e gente hebreia*  
 on the.MSG population.MSG and people.FSG hebrew.FSG  
 ‘on the hebrew people’ (de Almeida Torres, 1981)

Notice that in these examples the postnominal AP scopes over the whole coordinate phrase, not just the final noun (this is clear for (14), even out of context). Thus, these appear to be genuine cases of CCA, where the adjectives modify an entire coordinate structure, but only agree with one of the conjuncts (the closest).

<sup>4</sup>Compare examples like *my friend and colleague Mr. Smith* where a coordinate structure denotes a single entity rather than a plurality; cf. also the discussion around examples (26) and (25), below.

Given that a language permits both resolution and CCA for the same agreement process (here concord between N and postnominal AP), one might wonder whether the two strategies can be used simultaneously for different features. The following examples seem to illustrate exactly this, the third pattern that we find for postnominal APs: CCA for gender and resolution for number:

- (15) *todo o constrangimento e a dor sofridas*  
 all.MSG the.MSG embarrassment.MSG and the.FSG pain.FSG suffered.FPL  
 ‘all the embarrassment and pain suffered’
- (16) *o drama e a loucura vividas*  
 the.MSG drama.MSG and the.FSG madness.FSG lived/felt.FPL  
 ‘the drama and the madness experienced’
- (17) *o aprendizado e a experiência vividas*  
 the.MSG learning.MSG and the.FSG experience.FSG lived/felt.FPL  
 ‘the accumulated learning and experience’
- (18) *o romantismo e a morbidez profundas da alma alemã*  
 the.MSG romanticism.MSG and the.FSG morbidity.FSG deep.FPL of the  
 soul German  
 ‘the profound romanticism and morbidity of the German soul’
- (19) *uma relação entre sobrecarga do organismo e envelhecimento e morte prematuras*  
 a relation between overload of the organism and aging.MSG  
 and death.FSG premature.FPL  
 ‘A relation between overload of the organism and premature aging and death’

There is little literature to date on agreement strategies beyond simple resolution for Portuguese coordinate structures. One detailed descriptive grammar of Portuguese (de Almeida Torres, 1981) provides some discussion and exemplification of CCA within Portuguese NPs but does not mention this mixed pattern. In Section 4 we will present data from a corpus study which indicate that these ‘non-standard’ strategies are relatively common.<sup>5</sup>

### 3.2 Prenominal Modifiers

The interpretation of what goes on prenominally is somewhat less straightforward. Consider first examples such as the following:

---

<sup>5</sup>We should point out that some Portuguese speakers have serious reservations about at least some of these ‘mixed strategy’ examples (despite the fact that they are attested rather than constructed), and it is of course possible that some of them simply represent mistakes. However, our corpus study suggests the strategy is not uncommon (it appears in 90 instances in our sample, perhaps as many as 5% of relevant cases). Clearly, the matter deserves more study.

- (20) *suas próprias reações ou julgamentos*  
 his.FPL own.FPL reactions.FPL or judgements.MPL  
 ‘his own reactions or judgements’
- (21) *as assustadoras colinas e morros de argila do Parque Nacional*  
 the.FPL frightening.FPL mounds.FPL and hills.MPL of clay of the  
 National Park  
 ‘the frightening mounds and clay hills of the National Park’
- (22) *diversas secções ou subgrupos*  
 diverse.FPL sections.FPL or subgroups.MPL  
 ‘various sectors or subgroups’

Notice that these examples all involve coordinations of feminine and masculine nouns, in that order, and in each case the agreement features of the prenominal elements match those of the initial conjuncts. In fact, a gender mismatch between the first conjunct and the prenominal material appears to lead to ungrammaticality, as in (23). These data appear to indicate that gender resolution is not permitted prenominally, and CCA is the only possible strategy, at least for gender.

- (23) *\*suas próprias julgamentos ou reações*  
 \*his.FPL own.FPL judgements.MPL or reactions.FPL  
 ‘his own reactions or judgements’

However, in these examples all the conjoined nouns are plural, so they cannot be used to see whether CCA is also being used for number, or whether there is a mixture of CCA in gender with resolved agreement for number. Investigating this requires coordinations involving singular conjuncts. Unfortunately, further issues arise with singular conjuncts, which complicate matters.

On the one hand, there appear to be some clear cases of number resolution in prenominal modifiers, as can be seen from examples where there is a difference in number between prenominal modifiers and first conjunct:

- (24) *Os prováveis diretor e ator principal são Gus Van Sant e Johnny Deep, respectivamente*  
 the.MPL probable.PL director.MSG and actor.MSG principal.MSG are Gus  
 Van Sant and Johnny Deep respectively  
 ‘the likely director and main actor are, respectively, Gus Van Sant and Johnny Deep’<sup>6</sup>

To see whether CCA for number is also possible requires examples where a singular determiner precedes a coordinate structure denoting a plurality. King and Dalrymple (2004) suggest that this is impossible. They claim that the singular determiner *o/a* (‘the’) cannot modify conjoined singular nouns which referring to

<sup>6</sup>*prováveis* (‘probable’) is plural, but not marked for gender (like many other adjectives in Portuguese).

more than one individual. They contrast (25) with (26), which is acceptable, but receives a interpretation such that it refers to a single individual:

(25) \**o cachorro e gato*  
 the.MSG dog.MSG and cat.MSG  
 ‘the dog and cat’ King and Dalrymple (2004, 91)

(26) *o presidente e diretor da Air France*  
 the.MSG president.MSG and director.MSG of Air France  
 ‘the president and director of Air France’ King and Dalrymple (2004, 92)

One interpretation of this, which would be consistent with (24), would be that the determiner-noun agreement involves resolved number, closely tied to the semantics (a singular determiner is only possible with a coordinate structure which denotes a singular entity).

However, further work is required to determine whether this restriction is completely robust. For example (27), an attested example, is acceptable to the author of the present paper who is a native speaker of Portuguese (Villavicencio, who speaks Brazilian Portuguese), and the (constructed) examples (28) and (29) are judged acceptable by at least some native speakers. In each case there is a singular determiner scoping over a coordination of singular nouns referring to more than one individual (notice that in (28) and (29) the verbs are plural). On the face of it, these examples cannot involve resolved number agreement, and must involve CCA for number.

(27) *a correcta gestão e preservação*  
 the.FSG correct.FSG management.FSG and conservation.FSG  
 ‘the correct management and conservation’

(28) *o presidente e amigo comeram juntos*  
 the.MSG president.MSG and friend.MSG ate.3PL together  
 ‘the president and (his) friend ate together’

(29) *o chefe e vice-chefe estavam na reunião*  
 the.MSG chief.MSG and vice-chief.MSG attended.3PL the meeting  
 ‘the chief and vice-chief attended the meeting’

In summary, for prenominal dependents, gender agreement with the closest conjunct is always required. As for number agreement, there appear to be cases of resolved agreement. On the other hand, there is some evidence for the existence of cases of singular determiners scoping over coordinated singular nouns, which are interpreted as denoting pluralities. If so, these are cases which exhibit CCA in number. However, we will not try to settle this matter here.

### 3.3 Combining Prenominal and Postnominal Modifiers

Given that CCA is available for both pre- and post-nominal dependents, one might wonder if a coordination of (say) a masculine and a feminine nominal might be

able to trigger *different* agreement on pre- and post-head dependents. Examples like the following seem to show this is possible. In the following, *corações e mentes* triggers masculine agreement on the determiner, and feminine agreement on the postnominal adjective *brasileiras*:

- (30) *Esta canção anima os corações e mentes brasileiras.*  
This song animate the.MPL hearts.MPL and minds.FPL Brazilian.FPL

The significance of this it is not possible to define a a single feature or set of features to contain the ‘syntactic’ agreement properties of a coordinate structure (in the manner of most ‘standard’ approaches). Rather, a coordinate structure must make available several different collections of syntactic agreement features at the same time.

### 3.4 Summary

In this section we have presented evidence that suggests Portuguese uses a mixture of strategies for NP internal agreement. Prenominally, we have suggested that gender agreement involves CCA, but that the range of strategies involved in number agreement is less clear. Postnominally, we have suggested there may be three strategies:

1. resolution for number and gender;
2. CCA for number and gender;
3. a ‘mixed’ strategy: CCA for gender and resolution for number.

We have also noted that it seems possible for different strategies to be used for pre- and post-head dependents simultaneously.

Schematically, we might represent these alternatives for postnominal agreement as in (31)-(33).<sup>7</sup>

## 4 Data from a Corpus Study

One clear result of the preceding discussion would seem to be that Portuguese possesses a rather rich variety of agreement strategies in relation to coordinate structures. As part of our on-going investigation into this, a corpus study was carried out to estimate the approximate frequency of different agreement strategies. The initial results of this study relate to coordinate NPs modified by postnominal adjectives. Here we will report the results of an investigation which concentrated on postnominal *plural* adjectives, and was primarily intended to investigate the occurrence of gender agreement controlled by the closest conjunct.

We obtained occurrences of coordinated NPs followed by plural adjectives by posing Google queries of the following general format:

---

<sup>7</sup>Notice that the representation of prenominal agreement relations is the same in each. The use of dotted lines reflects our uncertainty about the proper account prenominal number agreement.

(31) Resolved number and gender:

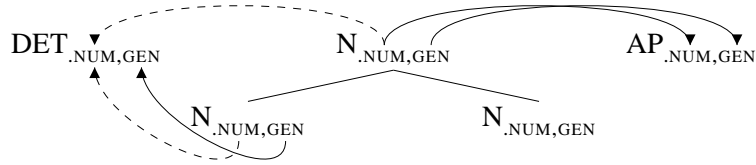

(32) CCA for number and gender:

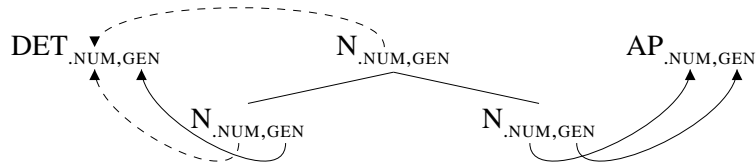

(33) CCA for gender, resolved number:

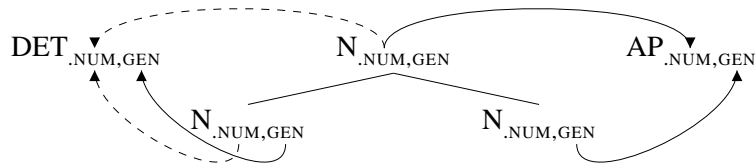

(34) "<ART> \* e <ART> \* <ADJ>"

Here ART stands for instances of the Portuguese (definite and indefinite) articles, ADJ stands for instances of Portuguese adjectives, and e is the Portuguese conjunction ('and'). The adjectives were extracted from the 1,528,590 entry NILC Lexicon.<sup>8</sup> As we were interested primarily in the correlation between the gender of each of the NPs and the gender of the adjective, only adjectives that overtly reflect gender distinctions were used (9,915 masculine and 9,811 feminine adjectives). The results were manually inspected to remove noise — in cases of putative CCA this entailed removing all cases in which, in the judgement of the Portuguese native speaker, the adjective should be interpreted as scoping only over the closest noun.

The results found are displayed in Tables 1 and 2, where 'Frequency' indicates the number of hits returned by Google for the searches, and 'NP1', 'NP2' and 'Adj' refer to the gender of the first conjunct, second conjunct, and adjective, respectively. Table 1 relates to coordinations of singular NPs, Table 2 relates to coordinations of singular NPs. In both cases the adjectives are all plural, however.

Several observations are worth making here. First, notice that row (d), which reports on 'masculine+feminine' coordinate structures triggering feminine agreement on a following adjective, unambiguously involves resolution for gender. As

<sup>8</sup>See <http://www.nilc.icmc.usp.br/nilc/index.html>.

	Frequency	NP1	NP2	Adj	
(a)	0	f	m	f	(resolve to f)
(b)	489	f	m	m	(cca/resolve to m)
(c)	460	m	f	f	(cca)
(d)	2317	m	f	m	(resolve to m)
total	3266				

Table 1: Frequency of Masc vs Fem Adjectives Modifying Mixed Gender Coordinate NPs (Plural).

	Frequency	NP1	NP2	Adj	
(a)	0	f	m	f	(resolve to f)
(b)	137	f	m	m	(cca/resolve to m)
(c)	90	m	f	f	(cca)
(d)	1737	m	f	m	(resolve to m)
total	1964				

Table 2: Frequency of Masc vs Fem Adjectives Modifying Mixed Gender Coordinate NPs (Singular).

one might expect, this pattern is very frequent. The agreement pattern reported in row (b) involves cases where the final conjunct is masculine, and could be instance of either gender resolution or closest conjunct gender agreement, since either would result in masculine agreement on the adjective.

On the other hand, row (c) represents cases of the ‘masculine+feminine’ coordinate structure triggering feminine agreement: these are instances of what we take to be CCA in Section 3. One striking result of this study is that this relatively little discussed pattern is actually not very infrequent. Notice that rows (c) and (d) correspond to those coordinate structures with final feminine conjuncts, that is, the cases in which the existence of CCA of gender could be unambiguously distinguished from other strategies. Thus, one relevant comparison is the ration of cases in (c) (apparent cases of CCA), compared to cases in (c)+(d) (that is, the total number of cases where we would be able to detect CCA if it occurred). We observe the CCA strategy in 460/2777 cases (16.56%) for plural NPs and 90/1827 (4.9%) cases for singular NPs, giving an overall frequency of some 550/4604 cases (11.9%). That is, even on the narrowest interpretation, that is, without considering additional coordinate structures with masculine final conjuncts (where CCA for gender cannot be unambiguously detected), the CCA for gender strategy is widespread, occurring in better than one in ten cases.

Second, notice that in each table, row (a) represents cases where a ‘feminine+masculine’ coordinate structure triggers feminine agreement — that is, what could only be cases of resolution to feminine. The fact that this is zero provides strong evidence that cases of feminine gender agreement in the presence of some masculine conjuncts as it occurs elsewhere should not be interpreted as the result

of a particular *resolution* strategy. This “unexpected” feminine gender agreement occurs *only* when the final conjunct is feminine. The zero score in (a) combined with the non-zero score in (c) is strongly suggestive that we have been correct in treating this pattern as a case of CCA.

The raw figures also display a strong and interesting bias for masculine conjuncts to precede feminine conjuncts (feminine conjuncts precede in only 626/5230 cases). This is likely to be a reflection a prescriptive bias in favour of this ordering of conjuncts.

Finally, recall that though we have reported numbers of singular and plural NPs separately, in both cases the post-nominal adjectives are plural. Thus, in Table 1, which reports numbers from plural NPs with plural adjectives, row (c) could be interpreted as showing CCA for both number and gender, or alternatively as showing the ‘mixed’ strategy of CCA for gender and resolution for number. However, the corresponding row in Table 2 is not open to this interpretation, the cases represented there involve singular NPs, with a plural adjective, so they can *only* be interpreted as involving a mixed strategy of CCA for gender and resolution for number. In our sample, then, this strategy is used 90 times, that is, in just under 5% of all cases involving singular NPs.

## 5 HPSG Analysis

To account for the cases of agreement described above, we propose an analysis that stores agreement information about the leftmost and rightmost conjuncts in two new agreement related features (i.e. in addition to CONCORD and INDEX features): LAGR for the leftmost conjunct, and RAGR, for the rightmost conjunct; CONCORD will be used to contain ‘resolved’ agreement information.

Like CONCORD, LAGR and RAGR are head features, defined on all sorts where CONCORD is defined (for concreteness, we assume this is at least the *head* values of nouns, determiners and adjectives), and ‘normally’ (e.g. in headed constructions) all three features share values. Thus, for example lexical nouns satisfy the constraint in (35). Since the features in question are *head* features, this identity carries over to N’ and NP:

$$(35) \textit{noun} \wedge \textit{lexical} \rightarrow \left[ \begin{array}{l} \text{SS} \mid \text{LOC} \mid \text{CAT} \mid \text{HEAD} \quad \left[ \begin{array}{l} \text{LAGR} \quad \boxed{\mathbb{1}} \\ \text{RAGR} \quad \boxed{\mathbb{1}} \\ \text{CONCORD} \quad \boxed{\mathbb{1}} \end{array} \right] \end{array} \right]$$

As will appear, the idea is that determiners and prenominal adjectives agree with nouns via LAGR (at least for gender), while postnominal adjectives agree with nouns via RAGR. Since for non-coordinate structures these features have the same value, this does not produce any observable effect.

However, in non-headed constructions, in particular, in coordinate structures, the identity between these values breaks down. Instead, the value of LAGR comes



from the LAGR of the leftmost daughter, and the value of RAGR from the RAGR of the rightmost daughter, while the CONCORD value reflects the resolved agreement features of the coordinate structure. To begin with, coordinate phrases which are defined for LAGR and RAGR (e.g. nominal-coordinated-phrases, *ncph*) satisfy the following constraint:

$$(36) \quad \left[ \begin{array}{l} \text{SS | LOC | CAT | HEAD} \quad \left[ \begin{array}{l} \text{LAGR} \quad \boxed{1} \\ \text{RAGR} \quad \boxed{2} \end{array} \right] \\ \text{CONJ-DTRS} \quad \left\langle \left[ \dots \text{HEAD | LAGR} \quad \boxed{1} \right], \dots, \left[ \dots \text{HEAD | RAGR} \quad \boxed{2} \right] \right\rangle \end{array} \right]_{ncph}$$

In words: the value of LAGR on a nominal coordinate phrase comes from the LAGR of the first/leftmost daughter of the phrase, RAGR comes from the RAGR of the last/rightmost daughter.

The value of CONCORD on the mother reflects resolved GENDER and NUMBER values computed from the values on the conjunct daughters. As regards NUMBER, we assume (in the absence of contradictory data) that resolution is simply a matter of semantics: (i) the value of INDEX | NUM on a nominal (coordinate or not) is plural whenever the nominal denotes a plurality; and (ii) the value of CONCORD just reflects this. As regards (ii), this means that all *head* values (including those on coordinate structures) satisfy (37):

$$(37) \quad \left[ \begin{array}{l} \text{CONTENT | INDEX | NUM} \quad \boxed{1} \\ \text{CONCORD | NUM} \quad \boxed{1} \end{array} \right]_{head}$$

In words, as regards NUMBER, CONCORD and INDEX are always identical.<sup>9</sup>

Resolution for GENDER is slightly more complex. To deal with it, we introduce two subtypes of nominal-coordinate-phrase (which is itself a subtype of coordinate phrase): one for coordinate phrases that resolve to masculine, and one for those that resolve to feminine.

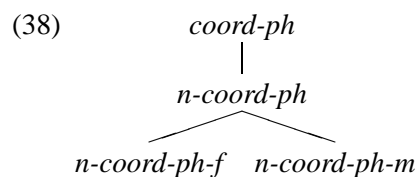

The relevant constraints on these sorts are as follows:

---

<sup>9</sup>As stated, this is a ‘hard’ constraint. It predicts that one should not find divergences of INDEX | NUMBER and CONCORD | NUMBER analogous to the divergence of gender observed with nouns like *Majestad* ‘Majesty’, mentioned in Section 2. That is, there should not be cases nouns denoting pluralities which trigger singular agreement, or *vice versa*. This is incorrect. For example, Wechsler and Zlatić (2003) discuss a class of collective nouns in Serbo-Croat (the ‘*deca*-type’) which trigger singular agreement inside NP. The constraint should be only a default. However, nothing else in the analysis hangs on this.

$$(39) \textit{n-coord-ph-f} \rightarrow \left[ \begin{array}{l} \text{SS | LOC | CAT | HEAD | CONCORD | GEND } \boxed{3} \\ \text{CONJ-DTRS } \left\langle \left[ \text{SS | LOC | HEAD | CONCORD | GEND } \boxed{3} \textit{fem} \right]^* \right\rangle \end{array} \right]$$

$$(40) \textit{n-coord-ph-m} \rightarrow \left[ \begin{array}{l} \text{SS | LOC | CAT | HEAD | CONCORD | GEND } \boxed{3} \\ \text{CONJ-DTRS } \left\langle \cdot *, \left[ \text{SS | LOC | HEAD | CONCORD | GEND } \boxed{3} \textit{masc} \right], \cdot * \right\rangle \end{array} \right]$$

In words, (39) says that a coordinate structure is feminine just in case all its daughters are feminine — intuitively, if its conjunct daughters list is of the form “fem\*”, a list of zero or more feminines; (40) says that a coordinate structure is masculine if it contains a single masculine daughter, that is, if it consists of a masculine daughter preceded and followed by zero or more other daughters — if it is “. \* , masc , . \*”, so to speak. These constraints are stated using regular expressions over conjunct daughters, which seems natural, but they could clearly be stated in many other ways, e.g. using list membership predicates.

The following will exemplify these constraints working together.<sup>10</sup>

(41) ... *o* *aprendizado* *e* *a* *experiência* (*vividas*) ...  
 ... the.MSG learning.MSG and the.FSG experience.FSG (lived.FPL) ...

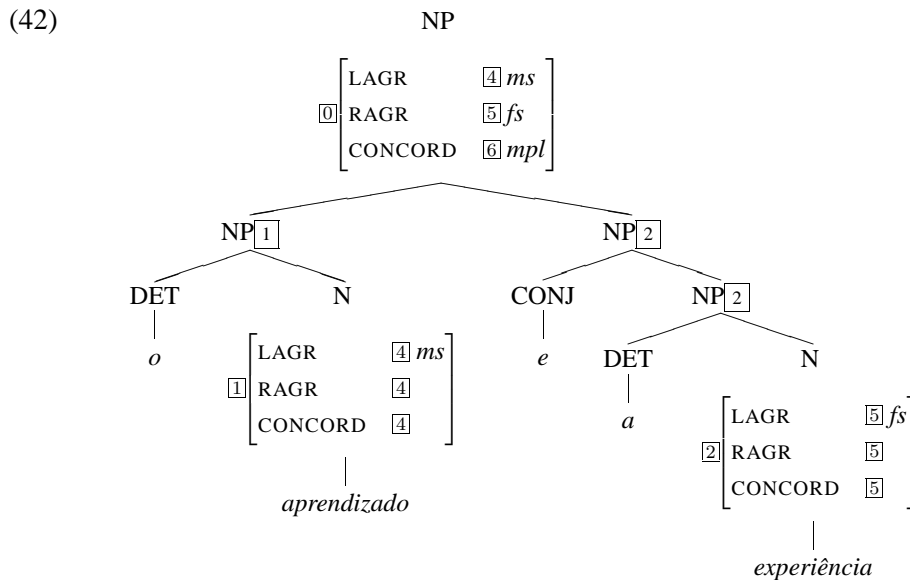

The values of LAGR, RAGR, and CONCORD are the same on each lexical noun (cf. constraint (35)); because these are *head* features, these values percolate to the NPs. The value of LAGR on the coordinate structure is  $\boxed{4}ms$  (i.e. masculine,

<sup>10</sup>We have assumed that the conjunct *e* ('and') forms a constituent with the final conjunct. Nothing hangs on this.

singular) — the same as the leftmost conjunct daughter, as required by (36). Similarly, the value of RAGR is  $\boxed{5}$ fs because that is the value of RAGR on the rightmost daughter. The value of CONCORD is *mpl: plural* because the coordinate structure denotes a plurality, *masc* because one of the conjunct daughters is masculine — cf. the structure satisfies (40), and does not satisfy (39).

Having described the propagation of agreement features in coordinate structures, we now turn to the matter of agreement with determiners and attributive adjectives. In section 3 we suggested the following patterns exist:

- Posthead:
  - CCA for NUMBER and GENDER;
  - resolution for NUMBER and GENDER;
  - resolution for NUMBER, CCA for GENDER.
- Prehead (Determiners and Prenominal Adjectives)
  - CCA (at least for GENDER).

As standardly assumed in HPSG, attributive adjectives, like other adjuncts, have (as part of their HEAD specification) a MOD feature which expresses constraints on the sort of object the adjective can modify. Agreement between attributive adjectives and nouns can be captured by stating constraints on the relation between the value of agreement features within this MOD value, and values on the adjective itself. If we take the general conditions on adjectival modifiers to be along the lines of (43a), we can capture the different agreement patterns if we require attributive adjectives to satisfy one of the additional constraints in the disjunction in (43b).

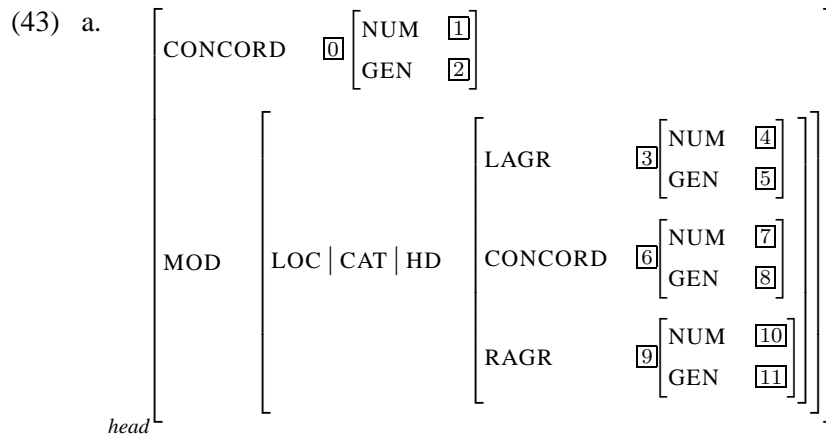

b.  $\boxed{0}=\boxed{6} \vee \boxed{0}=\boxed{9} \vee (\boxed{1}=\boxed{7} \wedge \boxed{2}=\boxed{11}) \vee \boxed{2}=\boxed{5}$

Let us consider these conditions in turn.

1.  $\boxed{0}=\boxed{6}$  identifies the adjective's CONCORD with the CONCORD value of the nominal it modifies. This is appropriate for an adjective under a resolution strategy (for both NUMBER and GENDER) — an adjective such as *modernos* in (44):

(44) *o homem e a mulher modernos*  
 [ the.MSG man.MSG and the.FSG woman.FSG ] modern.MPL  
 ‘the modern man and woman’

2.  $\boxed{0}=\boxed{9}$  identifies the adjective’s CONCORD with the RAGR of the nominal it modifies. This is appropriate for a post-head modifier under a CCA strategy (for both NUMBER and GENDER):

(45) *estudos e profissão monástica*  
 [ studies.MSG and profession.FSG ] monastic.FSG  
 ‘monastic studies and profession’

3.  $(\boxed{1}=\boxed{7} \wedge \boxed{2}=\boxed{11})$  identifies the adjective’s NUMBER value with the nominal’s CONCORD | NUMBER value (i.e the resolved NUMBER), and the adjective’s GENDER with the GENDER of the nominal’s RAGR. This is appropriate for the ‘mixed’ resolution/CCA strategy with post-head dependents:

(46) *o constrangimento e a dor sofridas*  
 [ the.MSG embarrassment.MSG and the.FSG pain.FSG ] suffered.FPL  
 ‘all the embarrassment and pain suffered’

4.  $\boxed{2}=\boxed{5}$  identifies the adjective’s CONCORD | GENDER with the LAGR | GENDER of the nominal it modifies. This is appropriate for pre-head modifiers under a CCA strategy for gender:<sup>11</sup>

(47) *suas próprias reações ou julgamentos*  
 his.FPL own.FPL [ reactions.FPL or judgements.MPL ]  
 ‘his own reactions or judgements’

This formulation evades the issue of number agreement for prenominal adjuncts — in section 3 we left open the question of whether they show resolution or CCA (or indeed both) for number. If they turn out to show CCA for number, then we should replace this equation with  $\boxed{0}=\boxed{3}$ ; resolved number can be stated as  $\boxed{1}=\boxed{4}$ .

We can now be slightly more precise. Supposing we have some way of picking out pre- and post-head adjectives (here we suppose there is a type distinction, but nothing hangs on this), we can say:

- (48) a. *post-head-attrib-adj* →  
 (43a)  $\wedge (\boxed{0}=\boxed{6} \vee \boxed{0}=\boxed{9} \vee (\boxed{1}=\boxed{7} \wedge \boxed{2}=\boxed{11}))$   
 b. *pre-head-attrib-adj* →  
 (43a)  $\wedge (\boxed{2}=\boxed{5} \vee \dots)$

In words, (48a) states that postnominal adjuncts can either (i) share have the resolved (i.e. CONCORD) value of the nominal, or (ii) its RAGR, or (iii) take GENDER from RAGR | GENDER, and NUMBER from the CONCORD | NUMBER of the

<sup>11</sup>We have highlighted *próprias* (‘own’) in (47), but of course *suas* (‘his/her’) shows the same agreement.

nominal (i.e. CCA for gender with resolved number). (48b) states that pre-head adjectives take their gender from the LAGR | GENDER of the noun (i.e. CCA for gender); ‘...’ can be filled in with whatever conditions turn out to be appropriate for prenominal number agreement. Together (48a) and (48b) amount to a straightforward statement of the descriptive generalizations we have seen in the preceding discussion.

We have not so far discussed determiners in this section. But this is straightforward: it is standardly assumed that determiners carry a SPEC feature, which constrains the kind of nominal the determiner can combine with. The appropriate constraint for determiners can be obtained by replacing MOD by SPEC in (43a).<sup>12</sup>

Notice that though we have exemplified these constraints with coordinate nominals, they apply equally, and without modification, to cases with non-coordinate nominals — it is just that with non-coordinate nominals LAGR, RAGR, and CONCORD are all identical. It is one of the attractions of this approach that it handles agreement in cases involving non-coordinate structures with the same apparatus as cases involving coordinate structures, without any extra complication of the grammar.

## 6 Conclusion

This paper has presented the results of an investigation of agreement processes involving NP/noun coordinations in Portuguese. We have provided a detailed description of some aspects of the phenomena, some of which appear to have been previously neglected, and given some of the results of a relatively large scale corpus study. Here the main results appear to be that what were thought to be relatively rare or non-existent agreement patterns are attested, and in some cases fairly widespread. We have suggested a way in which the phenomena can be described, expressed in the formalism of HPSG. The suggestion is that coordinate structures make available three kinds of ‘syntactic’ agreement related information: agreement properties from the leftmost conjunct; agreement properties from the rightmost conjunct; and ‘resolved’ agreement properties. The HPSG formalization of this analysis involves the introduction of two novel features (LAGR and RAGR, distinct from CONCORD), and a number of principles governing the way these features are projected.

The paper represents on-going work, which is part of a larger project on agreement processes, and it leaves a number of question open. We will highlight three.

First, and most obviously, we have made no commitment about the way in which number agreement works for prenominals. This clearly requires further exploration. One interesting question involves interaction with the semantics of de-

---

<sup>12</sup>Van Eynde (2003) argues that adjectives and determiners should not be distinguished in the way they select the nominals they modify, in which case the same constraint(s) would be able to deal with both.

terminers — for example, our existing data suggests that CCA for number is much more readily acceptable with indefinites than with definites.

Second, though we have identified different strategies, we have not addressed the question of what factors favour the choice of one strategy over another. Our preliminary data suggest that, postnominally, animate nouns overwhelmingly favour a resolution strategy, while the majority of CCA cases involve inanimate nouns.

Finally, we have concentrated entirely on NP-internal agreement processes, but other agreement processes appear to show CCA effects, leading one to wonder about the ‘syntactic persistence’ of features like LAGR and RAGR outside the NP, and their availability for other agreement processes. Consider the following example, which appears to show ‘predicate-argument CCA’:

- (49) *o travestismo e a copulação ritual são*  
the.MSG transvestism.MSG and the.FSG copulation.FSG ritual be.PL  
*realizadas para expressar ...*  
realized.FPL to express ...  
‘the transvestism and the ritual copulation are realized to express ...’

Notice that here the passive form *realizadas* (‘be realized’) is feminine singular, like the final conjunct of the subject (*copulação ritual* ‘ritual copulation’), though the subject itself denotes a plurality, and contains a masculine noun (giving it a resolved value of masculine plural).

## References

- Abeillé, Anne. 2004. A lexicalist and construction-based approach to coordinations. In Stefan Müller (ed.), *Proceedings of the HPSG04 Conference*, CSLI Publications, Katholieke Universiteit Leuven.
- Corbett, Greville G. 1991. *Gender*. Cambridge, UK: Cambridge University Press.
- Dalrymple, Mary and Kaplan, Ron. 2000. Feature indeterminacy and feature resolution in description-based syntax. *Language* 76(4).
- de Almeida Torres, Artur. 1981. *Moderna gramática expositiva da Língua Portuguesa*. Sao Paulo: Martins Fontes.
- Kathol, Andreas. 1999. Agreement and the Syntax-Morphology Interface in HPSG. In Robert Levine and Georgia Green (eds.), *Studies in Contemporary Phrase Structure Grammar*, pages 209–260, Cambridge and New York: Cambridge University Press.
- King, Tracy Holloway and Dalrymple, Mary. 2004. Determiner Agreement and Noun Conjunction. *Journal of Linguistics* 40, 69–104.

- Moosally, Michelle. 1998. *Noun Phrase Coordination: Ndebele Agreement Patterns and Cross-Linguistic Variation*. Ph. D.thesis, University of Texas at Austin, Austin, Texas.
- Moosally, Michelle J. 1999. Subject and object coordination in Ndebele: and HPSG analysis. In Sonya Bird, Andrew Carnie, Jason D. Haugen and Peter Norquest (eds.), *Proceedings of the WCCFL 18 Conference*, Cascadilla Press, Somerville, MA.
- Pollard, Carl J. and Sag, Ivan A. 1994. *Head-Driven Phrase Structure Grammar*. Chicago: University of Chicago Press.
- Sadler, Louisa. 1999. Non-Distributive Features in Welsh Coordination. In Miriam Butt and Tracy Holloway King (eds.), *Proceedings of LFG 1999*, Stanford, CA: CSLI Publications.
- Sadler, Louisa. 2003. Coordination and Asymmetric Agreement in Welsh. In Miriam Butt and Tracy Holloway King (eds.), *Nominals: Inside and Out*, pages 85–118, Stanford, CA: CSLI.
- Van Eynde, Frank. 2003. On the Notion ‘Determiner’. In Stefan Müller (ed.), *Proceedings of the HPSG-2003 Conference, Michigan State University, East Lansing*, pages 391–396, Stanford: CSLI Publications.
- Wechsler, Stephen and Zlatić, Larisa. 2001. A Theory of Agreement and its application to Serbo-Croatian. *Language* pages 391–423.
- Wechsler, Stephen and Zlatić, Larisa. 2003. *The Many Faces of Agreement*. Stanford, CA: CSLI Publications.
- Yatabe, Shûichi. 2004. A Comprehensive Theory of Coordination of Unlikes. In Stefan Müller (ed.), *Proceedings of the HPSG04 Conference*, pages 335–355, CSLI Publications, Katholieke Universiteit Leuven.

**Part II**

**Contributions to the Workshop**



# Georgian reflexives in subject function in special contexts

Nino Amiridze 

Utrecht University

Proceedings of the 12th International Conference on  
Head-Driven Phrase Structure Grammar

Department of Informatics, University of Lisbon

Stefan Müller (Editor)

2005

Stanford, CA: CSLI Publications

pages 449–466

Amiridze, Nino. 2005. Georgian reflexives in subject function in special contexts. In Stefan Müller (ed.), *Proceedings of the 12th International Conference on Head-Driven Phrase Structure Grammar, Department of Informatics, University of Lisbon*, 449–466. Stanford, CA: CSLI Publications. DOI: 10.21248/hpsg.2005.26.



## Abstract

Georgian is a language allowing reflexives to be marked by ergative. The subject use of the Georgian reflexive phrase was first documented with causative verbs by Asatiani (1982). The later works such as (Amiridze and Everaert, 2000), (Amiridze, 2003), (Amiridze, 2004) discuss the use with object-experiencer verbs and transitive verbs on non-agentive reading. The present paper offers the first hand data on subject uses of the Georgian reflexive phrase with transitive verbs on their agentive reading in special contexts (such as a twin context, Madame Tussaud context, etc.) which are problematic for the Binding Theory of Chomsky (1981) as well as for the Reflexivity Theory of Reinhart and Reuland (1993). The data could be accounted for within the approach developed in (Reuland, 2001). However, the subject uses of the Georgian reciprocal *ertmanet-* leave the issue of subject anaphors open.

## 1 Introduction

The paper deals with the subject occurrences of the Georgian reflexive phrase exemplified in 1 and 2. In both examples the reflexive phrase *tavis-ma tav-ma* is marked by ergative and it triggers the Set A agreement suffix *-a* which is the agreement marker for subject arguments in the Aorist Indicative. The phrase is the subject argument of the verb forms *da-∅-marx-a* (1) and *ga-∅-u-γim-a* (2).

- (1) [tavis-ma tav-ma] da-∅-marx-a  
self's-ERG<sup>1</sup> self-ERG PV-3<sub>NOM</sub>.SG-bury-3<sub>ERG</sub>.SG.AOR.INDIC  
mixa.  
Mixa.NOM  
Lit.: Himself.ERG buried Mixa.NOM
- a. "Some property of Mixa ruined his life/career."  
b. "Mixa's savings made it possible to pay for the expenses related to his funeral."

---

<sup>†</sup>This research was supported by the Language in Use project of the Utrecht Institute of Linguistics OTS. I am grateful to Martin Everaert, Alice C. Harris and Eric Reuland for the insightful comments on an earlier version of this work. Special thanks go to Kevin Tuite for suggesting to consider subject uses of Georgian reciprocals as well. All errors are mine.

<sup>1</sup>Abbreviations: 3=3rd person; A=Set A agreement marker; ABS=absolute; ACC=accusative; ADV=adverbial; AOR=aorist; AUX=auxiliary; B=Set B agreement marker; CL=clitic; CLASS=class; DAT=dative; DET=determiner; EMPH=emphatic; ERG=ergative; EV=epenthetic vowel; FOC=focus; GEN=genitive; HAB=habitual; INDIC=indicative; INST=instrumental; M=masculine; NOM=nominative; NP=noun phrase; OBL=oblique; PART=particle; PL=plural; PRES=present; PRV=pre-radical vowel; PV=preverb; R=R(eferential); REC=reciprocal; REFL=reflexive; SE=type of anaphor; SELF=type of anaphor; SG=singular; SUBJ=subjunctive.

The indices show the case of the argument triggering the particular agreement marker. For instance, 3<sub>NOM</sub>.SG=3rd person singular Set B agreement marker triggered by the NOM argument;

- (2) [tavis-ma tav-ma] ga-∅-u-γim-a  
 self's-ERG self-ERG PV-3<sub>B<sub>DAT</sub>.SG-PRV-smile-3<sub>A<sub>ERG</sub>.SG.AOR.INDIC</sub>  
 gogo-s sark-i-dan.  
 girl-DAT mirror-INST-from  
 Lit.: Herself smiled to the girl from the mirror.  
 “The reflection of the girl<sub>i</sub> smiled to her<sub>i</sub> from the mirror.”</sub>

Note that in 1 and 2 the relation between the referents of the reflexive phrase and its postcedent is not of a full but rather of a partial identity. In 1 the reflexive phrase refers to an aspect/property or the referent of the postcedent while in 2 it refers to an image/representation of the referent of the postcedent.

The subject uses of the Georgian reflexive phrase are problematic for various theories dealing with anaphoric dependencies. In this paper I will review the facts already reported in the literature as well as bring some new data. Section 2 gives some basic facts about the Georgian reflexive phrase which seems to obey the binding principles (Chomsky, 1981); Section 3 will, however, focus on the non-anaphoric behavior of the reflexive phrase which is able to surface as a subject argument of verbs; Section 4 argues whether the relation between the subject uses of the reflexive phrase and their postcedents is that of binding; Section 5 examines whether the form of the anaphor can influence its interpretation. For the similar Greek facts a solution has been proposed by Anagnostopoulou and Everaert (1999) within the Reflexivity Theory of Reinhart and Reuland (1993). However, the Georgian reciprocal *ertmanet-*, also being able to act as a subject argument of verbs, makes the application of the solution to Georgian data problematic. Section 6 examines a hypothesis on the importance of the verb classes proposed by Amiridze (2004). Although there is a clear cut distinction between the subject-experiencer verbs versus object-experiencer verbs, the former disallowing while the latter allowing the reflexive phrase as a subject argument, it is not necessary for a verb to be an object-experiencer verb to be able to take a reflexive phrase as a subject, as was previously proposed by Amiridze (2004). The new facts presented in Section 7 illustrate subject uses of reflexives with typical transitive verbs in special contexts. Especially relevant to those facts seems to be the Reuland (2001)'s analysis of complex anaphors as a relevant function of the antecedent. However, again the Georgian reciprocal *ertmanet-* unable to be analyzed as a complex anaphor but being able to appear as a subject argument leaves the issue of subject anaphors open for further investigation.

## 2 Georgian Reflexive Phrase Obeying Binding Principles

Georgian has a complex anaphoric phrase with the grammaticalized body-part *tav-* “head” as its head and a possessive pronoun as its determiner. The literal translation

---

<sup>3</sup><sub>A<sub>ERG</sub>.SG</sub>=3rd person singular Set A agreement marker triggered by the ERG argument (Example 1).

of the whole expression is “one’s head”. However, it no more means a body-part in reflexive constructions; see (Shanidze, 1973), (Harris, 1981). The reflexive phrase has to be bound in a local domain necessarily by a c-commanding antecedent and can never be used as a long-distance anaphor (3) or in logophoric contexts (4).

- (3) *ilia<sub>i</sub> pikrobs, rom gia-s<sub>j</sub> sjera, kaxa-s<sub>k</sub> surs,*  
*Ilia.NOM he.thinks that Gia-DAT he.believes Kakha-DAT he.wants*  
*bakar-is<sub>l</sub> zma-m<sub>m</sub> akos tavis-i tav-i<sub>\*i/\*j/\*k/\*l/m</sub>.*  
*Bakar-GEN brother-ERG he.praises.SUBJ self’s-NOM self-NOM*  
 “*Ilia<sub>i</sub> thinks that Gia<sub>j</sub> believes [that] Kakha<sub>k</sub> wants [that] Bakar<sub>l</sub>’s brother<sub>m</sub>*  
*praises himself<sub>\*i/\*j/\*k/\*l/m</sub>.”*
- (4) *\*šen-i tav-is msgavs-i xalx-is-tvis diktaṭor-s*  
*your.SG-NOM self-GEN alike-NOM people-GEN-for dictator-DAT*  
*qoveltvis moeṭebneba ert-i saṭan-i.*  
*always it.can.be.searched.by.him/her one-NOM prison.cell-NOM*  
 “*For people like yourself the dictator always has a prison cell.*”

The Georgian reflexive phrase requires a c-commanding antecedent (3). Irrespective of what is the order of the arguments in a sentence, it is only the direct object argument of a 2-argument verb which can be realized as a reflexive (cf. the examples 5a vs. 5b and 6b vs. 6a).

- (5) a. *ḱac-i<sub>i</sub> akebs [tavis tav-s]<sub>i</sub>.*  
*man-NOM he.praises.him self’s self-DAT*  
 “*The man praises himself.*”  
 b. *[tavis tav-s]<sub>i</sub> akebs ḱac-i<sub>i</sub>.*  
*self’s self-DAT he.praises.him man-NOM*  
 “*The man praises HIMSELF.*”
- (6) a. *\*[tavis-i tav-i]<sub>i</sub> akebs ḱac-s<sub>i</sub>.*  
*self’s-NOM self-NOM he.praises.him man-DAT*  
 b. *\*ḱac-s<sub>i</sub> akebs [tavis-i tav-i]<sub>i</sub>.*  
*man-DAT he.praises.him self’s-NOM self-NOM*

The importance of c-command is clear also from the 3-argument structures where an indirect object cannot be bound by a direct object irrespective of what is the order of these arguments (cf. 7 vs. 8):

- (7) *giorgi-m<sub>i</sub> [tavis tav-s]<sub>i/\*j</sub> bakar-i<sub>j</sub> aṛuṭera.*  
*Giorgi-ERG self’s self-DAT Bakar-NOM he.described.him.to.him*  
 “*Giorgi described Bakar to himself.*”
- (8) *giorgi-m<sub>i</sub> bakar-i<sub>j</sub> [tavis tav-s]<sub>i/\*j</sub> aṛuṭera.*  
*Giorgi-ERG Bakar-NOM self’s self-DAT he.described.him.to.him*  
 “*Giorgi described Bakar to HIMSELF.*”

Both in 2- and 3-argument structures the antecedent must c-command the anaphor, and neither case morphology (being dependent on the tense, aspect, mood, verb class and volitionality) nor word order affects this.

### 3 Georgian Reflexive Phrase Violating Binding Principles

However, the reflexive phrase may also perform an exceptional behavior—it can be marked by ERG case marker and function as a subject argument.<sup>2</sup> Asatiani’s original examples of ergative-marked reflexive phrases involve causative verbs where the subject argument is given as a reflexive phrase (9). According to Amiridze and Everaert (2000) and Amiridze (2004), also transitive verbs can take the reflexive phrase marked by ergative as an argument but on a non-agentive reading (10). The same phenomenon with the so-called object experiencer verbs allowing their subject argument to be a reflexive (11) is discussed in (Amiridze, 2003).

- (9) (Asatiani, 1982, p. 86)

tavis-ma tav-ma gaak̄etebina nino-s es.  
self’s-ERG self-ERG she.made.her.do.it nino-DAT this.NOM

“(Something in) Nino<sub>i</sub>’s personality made her<sub>i</sub> do this.”

- (10) (Amiridze, 2004, p. 437)

tavis-i tav-i ačamebs k̄ac-s.  
self’s-NOM self-NOM he.is.torturing.him man-DAT

Lit.: Himself is torturing the man.

“His own property(/properties) make(s) the man suffer.”

- (11) (Amiridze, 2003)

[tavis-ma<sub>i</sub> tav-ma<sub>j</sub>]<sub>j</sub> gaaoca [k̄ac-i]<sub>i</sub>.  
self’s-ERG self-ERG he.surprised.him man-NOM

“The man got surprised because of something related to himself.”

From the Binding Theory perspective (Chomsky, 1981), such sentences as those in the examples 9, 10 and 11 are problematic because there the reflexive phrases do not have a c-commanding antecedent. Cross-linguistically there are languages

<sup>2</sup>It should be noted that subject arguments can be not only ergative-marked. Verbs of different verb classes have different alignment in different Tense-Aspect-Modality (TAM) Series (see, for instance, (Anderson, 1984), (Aronson, 1994), (Boeder, 1989), (Hewitt, 1995), (Kvatchadze, 1996), (Shanidze, 1973) among many others). For instance, transitive verbs have the subject argument marked by ERG in TAM Series II, by NOM in TAM Series I and by DAT in TAM Series III. Thus, the examples of subject reflexives (or subject reciprocals) are not only those marked by ERG (cf. 9, 10, 11) but also those marked by NOM (cf. 26a) or DAT.

which have anaphors without a c-commanding antecedent, qualified as logophors. However, the absence of a c-commanding antecedent does not make the reflexive phrase *tavis- tav-* in the examples 9, 10 or 11 a logophor with an antecedent in the possible previous discourse. In fact the only NP (*nino-s* in 9, *ḱac-s* in 10 or *ḱac-i* in 11) on which the interpretation of the reflexive phrase depends is a co-argument and, in fact, is in the same local domain as the reflexive. Since the reflexive phrases in subject position in the examples 9, 10 and 11 are referentially dependent on a co-argument NP, they are anaphoric elements rather than pronominals or R-expressions. The case-marking and the agreement pattern they trigger as well as their referential behavior only indicates that they are anaphoric elements acting as a subject argument.

#### 4 Can It Be Called Binding?

In order to make sure the relation between the ergative-marked subject reflexive phrase and its nominative postcedent in the examples 9 and 11, or between the nominative-marked subject reflexive phrase and its dative postcedent in 10, is a binding not just a coreference let us check subject anaphors with a quantificational postcedent.

As known, a pronominal can be dependent on the interpretation of a quantificational expression if there is a binding relation between them. For instance, the pronominal *he* in Example 12a cannot get the value of the quantificational expression *everyone* because there is no binding relation between them. However, the pronominal *he* can get the value of the quantificational expression when there is a binding relation between the two as in Example 12b:

(12) (Reuland and Everaert, 2001)

- a. \*Everyone<sub>i</sub> had been worrying himself stiff. He<sub>i</sub> was relieved.
- b. Everyone<sub>i</sub> who had been worrying himself stiff said that he<sub>i</sub> was relieved.

If in Georgian the interpretation of the reflexive phrase in subject position is dependent on the interpretation of the postcedent quantificational expression, we could argue that there is a binding relation between the anaphoric phrase and the quantificational expression. Thus, we could argue that there is a binding relation between the subject anaphor and its postcedent. Therefore, in general, subject anaphors in Georgian could be claimed to bind their postcedents and not just be coreferential with them.

Below I bring some examples of the reflexive phrase as a subject argument with a quantificational postcedent in 13, 14, 15. Each of these examples has an ergative marked reflexive phrase *tavis-ma tav-ma* as a subject argument. The interpretation of the reflexive phrase *tavis-ma tav-ma* “himself/herself” is dependent on the interpretation of the postcedent *qvela-∅* “everybody”, showing a relation of variable binding:

- (13) cxovreba-ši ertxel mainc tavis-ma tav-ma qvela  
 life-in once at.least self's-ERG self-ERG everybody.NOM  
 šeižleba daaprtxos.  
 it.is.possible (s)he/it.scares.SUBJ.him/her  
 Lit.: In.the.life once at.least himself/herself everybody it.is.possible  
 (s)he/it.scares.SUBJ.him/her.  
 “At least once in the life everybody can get scared of himself/herself.”
- (14) tquil-ad daabralebt zemo-dan zeçola-s, uzraob-is  
 lie-ADV you.PL.will.blame.it above-from press-DAT Stagnation-GEN  
 çl-eb-ši mainc, tavis-ma tav-ma ubižga  
 year-PL-in at.least self's-ERG self-ERG (s)he/it.pushed.him/her  
 qvela-s, šesuliqo partia-ši.  
 everybody-DAT him/her.to.be.entered party-in  
 Lit.: Wrongly you.PL.will.blame.it from.above press. Of.Stagnation in.years  
 at.least self's self it.pushed.him/her everybody to.join party.  
 “You.PL will wrongly blame the press from above, at least in the years of  
 Stagnation everybody was pushed by himself/herself to enter the party.”<sup>3</sup>
- (15) gadamçqvet moment-ši tavis-ma tav-ma qvela  
 decisive moment-in self's-ERG self-ERG everybody.NOM  
 šeižleba daapikros.  
 it.is.possible (s)he/it.makes.SUBJ.him/her.start.think  
 Lit.: Decisive moment.in himself/herself everybody it.is.possible  
 (s)he/it.makes.SUBJ.him/her.start.think.  
 “In a decisive moment a property/aspect of one's own can make everybody  
 start thinking.”

That the reflexive phrase is the subject argument of the verb forms in the above given examples 13, 14 and 15 can be checked by a substitution test correspondingly in the examples 16, 17 and 18:

- (16) cxovreba-ši ertxel mainc umçeob-is grznoba-m qvela  
 life-in once at.least helplessness-GEN feeling-ERG everybody.NOM  
 šeižleba daaprtxos.  
 it.is.possible (s)he/it.scares.SUBJ.him/her  
 Lit.: In.the.life once at.least of.helplessness feeling everybody it.is.possible  
 (s)he/it.scares.SUBJ.him/her.  
 “At least once in the life the feeling of helplessness can scare everybody.”

<sup>3</sup>What is meant by Example 14 is the following: in the former Soviet Union in the years of Stagnation (1970's) people used to join the already corrupt communist party more to use the membership for their own carrier, rather than for sharing the principles of the party.

- (17) *t̄q̄uil-ad daabralebt zemo-dan zeçola-s, uzraob-is*  
*lie-ADV you.PL.will.blame.it above-from press-DAT Stagnation-GEN*  
*çl-eb-ši mainc, uket moçqob-is survil-ma*  
*year-PL-in at.least better making.oneself.comfortable-GEN will-ERG*  
*ubizga qvela-s, šesuliqo partia-ši.*  
 (s)he/it.pushed.him/her everybody-DAT him/her.to.be.entered party-in  
 Lit.: Wrongly you.PL.will.blame.it from.above press. Of.Stagnation in.years  
 at.least better of.making.oneself.comfortable will it.pushed.him/her every-  
 body to.join party.

“You.PL will wrongly blame the press from above, at least in the years of Stagnation the will to make oneself comfortable pushed everybody to enter the party.”

- (18) *gadamçqveṭ moment-ši tavis-ma tviseb-eb-ma qvela*  
*decisive moment-in self’s-ERG quality-PL-ERG everybody.NOM*  
*šeižleba daapikros.*  
*it.is.possible (s)he/it.makes.SUBJ.him/her.start.think*  
 Lit.: Decisive moment.in self’s qualities everybody it.is.possible  
 (s)he/it.makes.SUBJ.him/her.start.think.

“In a decisive moment one’s own qualities can make everybody start thinking.”

Thus, the reflexive phrase in subject position has to be co-valued with an argument in the VP not only when the argument is a referential expression (as in 9, 10 and 11) but also when it is quantificational (as in 13, 14 and 15). Therefore, the cases with quantificational postcedents in 13, 14 and 15 illustrate variable binding, not just coreference, between the subject anaphor and its postcedent.

## 5 Is the Form of the Anaphor Responsible for Its Interpretation?

Like Georgian, there are some other languages too allowing reflexives to occupy a subject position under certain conditions. For instance, Everaert (2001) observes that the Georgian reflexive phrase *tavis- tav-* is structurally very similar to the Greek anaphor *o eaftos tu* (as described in (Iatridou, 1988) and (Anagnostopoulou and Everaert, 1999)) which is also able to appear as a subject (19, 20):

- (19) (Anagnostopoulou and Everaert, 1999)

[O eaftos<sub>j</sub> tu<sub>i</sub>]<sub>j</sub> ton provlimatizi [ton Petro]<sub>i</sub>.  
 The self his CL.ACC puzzles the Peter.ACC

“Himself puzzles Peter.”



(20) (Anagnostopoulou, 1999)

Tin Maria tin provlimatizi/enoxli/anisihi o eaftos tis.  
The Maria.ACC CL.ACC puzzles/bothers/worries the self her

“Maria is puzzled/bothered/worried with/at/by herself.”

The same applies to the Basque anaphor which has a similar structure and which also may serve as a subject in certain cases (21, 22):

(21) Basque, X. Artiagoitia, personal communication, 2001

[neure<sub>i</sub> buru-a-k<sub>j</sub>]<sub>j</sub> hilko nau (ni<sub>i</sub>).  
my head-DET-ERG it.kills.me me.has.it I

Lit.: Myself kills me.

“Something like my personality, the things I do and worry about... that is going to kill me.”

(22) Basque, from I. Laka’s Basque Grammar Page

Egunotan, neure buru-a-k kezkatzen nau (ni).  
day.DET.in my head-DET-ERG worry.HAB me.has.it I

“These days, my(own)self worries me.”

Whether it is Greek (19, 20), Basque (21) or Georgian (11), only the possessor within the reflexive NP has an agreement relation with the postcedent. It is claimed in (Everaert, 2001) and (Everaert, 2003) that precisely because of such structure of the anaphor Georgian allows a locally bound “subject” anaphor. In 11 the predicate is both reflexive and reflexive-marked satisfying binding conditions A and B of the Reflexivity Theory (Reinhart and Reuland, 1993); and because of its internal structure (the two co-indexed elements *tavis-* and *ḱac-* in 11 do not form an A-chain) the reflexive is able to escape Chain Formation violation.

The A-chain cannot be formed also because the reflexive phrases in these languages qualify as a [+R, +SELF] anaphor. Being fully specified for phi-features (and, thus, being [+R]), these anaphors are unable to form an A chain with the antecedent because according to Reinhart and Reuland (1993)’s chain condition the formation of A chains with two [+R] links is not allowed.

However, as argued in (Amiridze, 2003) and (Amiridze, 2004), if only the structure of an anaphor matters (enabling to escape the Chain Formation) then the anaphor has to be grammatical in subject position in Georgian, Greek or Basque with any verb but it is not (see 23 for Georgian, 24 for Greek and 25 for Basque).

(23) Georgian, from (Amiridze, 2004, p. 437)

\*tavis-i tav-i açamebs ḱac-s.  
self’s-NOM self-NOM he.is.torturing.him man-DAT

Himself is torturing the man. (Agentive reading)

(24) Greek, from (Anagnostopoulou, 1999)

\*Tin Maria den tin thavmazi/aghapai o eaftos tis.  
The Maria.ACC not CL.ACC admires/likes the self her

Herself doesn't admire/like Mary.

(25) Basque, from (Artiagoitia, 2003, p. 622)

\*Bere buru-a-k Mirande hil zuen.  
his head-DET-ERG Mirande kill AUX

Himself killed Mirande.

Also, the subject uses of the Georgian reciprocal *ertmanet-* show that the *aspect/property of reading* has nothing to do with the form of the anaphor. The reciprocal when appearing in subject position only has the *aspect/property of reading* (cf. 26a) but it neither forms a possessive construction nor is derived from any body-part (27).

- (26) a. ertmanet-i amxiarulebt bavšv-eb-s.  
REC-NOM it.makes.them.cheerful child-PL-DAT  
“Something in each other makes the children cheerful.” (i.e., their behavior, the way they look, etc.) (Non-agentive reading)
- b. bavšv-eb-i ertmanet-s amxiaruleben.  
child-PL-NOM REC-DAT they.make.them.cheerful  
“The children make each other cheerful.” (i.e., by performing, telling, etc.) (Agentive reading)

- (27) ertmanet- < ert+man+ert-  
one+ERG+one-  
“each other”

Thus, the *aspect/property of reading* of the reflexive phrase in the subject position is not related to the structure, otherwise the reciprocals would also be of a possessive form but they are not (27).

## 6 Do Verb Classes Play a Role?

As argued by Amiridze (2004), since the formally different reflexive phrase and the reciprocal *ertmanet-* when put in a subject position of a certain class of verbs both get interpreted alike, the similar interpretation has to be related to the verb class rather than to the form of any of the anaphors.

Observe that the anaphors are grammatical exclusively on the object experiencer reading of the originally transitive verbs but not on the agentive one (cf. the examples 10 vs. 23 for Georgian and 25 vs. 21 for Basque). Also, notice that none of the subject experiencer verbs are able to take the reflexive phrase as a subject argument (see 28a for Georgian, 24 for Greek and 29 for Basque). According to the data, Amiridze (2004) concludes that the subject anaphors are unable to refer to either an agent or an experiencer.

(28) (Amiridze, 2003)

- a. \*tavis tav-s uqvars ivane.  
 self's self-DAT he.loves.him Ivane.NOM  
 Himself loves Ivane.
- b. ivane-s uqvars tavis-i tav-i.  
 Ivane-DAT he.loves.him self's-NOM self-NOM  
 "Ivane loves himself."

(29) Basque, I. Laka, personal communication, 2001

\*Bere buru-a-k Miren maite du.  
 her head-DET-ERG Miren.ABS love has

Herself loves Miren.

It has been argued by Amiridze (2004) to relate the interpretation of the anaphors which they get in the subject position of the verbs under the object experiencer reading to the thematic properties of the verbs under the very reading. Namely, it has been argued that although the form and the anaphoric properties of the reflexive phrase and the reciprocal *ertmanet-* differ, they get the same kind of interpretation because the verb reading can only be associated with the subject argument of the type of cause rather than of the agent. In other words, the anaphors get interpreted not fully identical to the postcedent but as an aspect/property of it because the verbs taking them as a subject argument can only have a cause but not an agent as a subject.

However, there remain several questions. First of all, if the reason of having subject anaphors is in the thematic properties of verbs, then why subject anaphors with object experiencer verbs and transitive verbs on a non-agentive reading are disallowed in so many languages, even in those which have a formally similar reflexives? For instance, although Dargwa (30a) and Bagwalal (31a) allow subject occurrences of the reflexive phrase of an inalienable type, similar to the reflexive phrases of Georgian, Greek and Basque, they does not get interpreted as an aspect/property of the postcedent. Rather in Dargwa and Bagwalal the use is, in fact, intended to correct the expectation of the hearer (cf. 30a vs. 30b, 31a vs. 31b):

(30) Dargwa, (Kibrik, 1997, p. 300)

- a. *musa caratajir cin-na cin-ni c'aIq'il*  
 Musa-NOM than.others REFL-GEN REFL-ERG more  
*gap'irq'aca-w.*  
 praise.PRES-CLASS1  
 “Musa praises himself more than others (praise him).”
- b. *musa-l caratajir cin-na ca-w c'aIq'il*  
 Musa-ERG than.others REFL-GEN REFL-NOM-CLASS1 more  
*gap'irq'aca-w.*  
 praise.PRES-CLASS1  
 “Musa praises himself more than (he praises) others.”

(31) Bagwalal, (Ljutikova, 1999, p. 176)

- a. *in-çu-r-da ima w=eSiSi.*  
 REFL-OBL.M-ERG-EMPH father M=praise  
 Lit.: Himself.ERG praised father.ABS.  
 Context: No one praised the father.
- b. *ima-çu-r e=w-da w=eSiSi.*  
 father-OBL.M-ERG REFL=M-EMPH M=praise  
 Lit.: Father.ERG praised himself.ABS.  
 Context: The father did not praise anyone.

The next question arises if we consider not just the group of examples of subject anaphors with transitive verbs on a non-agentive reading but also those examples where there is no change in the thematic properties of transitive verbs and still the subject anaphors are allowed. Such examples are those in 9, 32 which use a verb form referring to a transitive action carried out by a subject affecting a theme. Although the subject argument refers exclusively to a cause rather than to an agent, the object argument is still a theme affected by the subject.

(32) (Amiridze and Everaert, 2000)

*tavis-ma tav-ma ixsna prezident-i.*  
 self's-ERG self-ERG (s)he.saved.him/her president-NOM

“It was his/her own positive personal properties, and/or his/her achievements, etc., that saved the president.”

Thus, it is not the semantics and thematic properties of the verb readings which constrain the interpretation of the anaphors in subject position. Subject anaphors in Georgian are available both on the non-agentive and the agentive readings of transitive verbs. Thus, their interpretation as an aspect/property of the postcedent is not conditioned by the verb semantics.

## 7 Special Contexts

The examples below also involve transitive verbs on their agentive reading and allow the subject reflexive phrase to be interpreted as an image/representation of the postcedent. These uses also turn out to be problematic if we want to relate the availability of the subject anaphors with the thematic properties of verbs allowing them.

These are the cases where the referent of the reflexive is not an aspect/property of the referent of its postcedent but a representation such as a TV image (33), a recorded voice (34), a close associate or someone closely resembling, for instance, a twin sibling (35). These are contexts with identity splits, or those reflecting dream/unreal worlds, associations. In these special, representational, contexts the transitive verbs taking an ergative reflexive phrase as an argument do have an agentive reading.

### (33) TV-image context

televizor-is ekran-i-dan [tavis-ma tav-ma]  
 TV-GEN screen-INST-from self's-ERG self-ERG  
 damozγvra parti-is lider-i.  
 (s)he.instructed.him/her party-GEN leader-NOM

Lit.: From the TV screen himself.ERG instructed party leader.NOM.

The context: The leader of the party was watching his own speech on the TV and was instructed by himself as an ordinary TV viewer would have been instructed by a party leader.

### (34) Voice recording context

xširad ucnaur-i gržnoba mičndeba, roca [čem-i-ve  
 often strange-NOM feeling.NOM it.appears.to.me when my-NOM-FOC  
 tav-i] meubneba, ris šemdeg ra unda gavaḳeto.  
 self-NOM (s)he.tells.me what.GEN after what should I.do.SUBJ

[“Sometimes I dial my home number and leave a list of instructions for myself on the voice mail in order to listen to them when returned back home and remind myself what still has to be done for the next day.] I often get a strange feeling when [I hear my own voice and realize that it is] myself [who] tells me what has to be done and in which order.”

### (35) Twin context

mašin ḳi martla vipikre, rom mesizmreboda, rogor  
 then PART really I.thought that I.was.dreaming.about.it how  
 ḳocnida [tavis-i tav-i] natia-s.  
 she.was.kissing.her self's-NOM self-NOM Natia-DAT

[An amazed viewer: “I came out and got amazed. Natia has turned into two persons. They stood and talked to each other. Finally they also kissed each other.] It was only then when I really thought that I was dreaming how Natia was being kissed by her(own)self.”

In the TV image context in 33 the referent of the postcedent, the full NP *part̄i-is lider-i*, refers to a certain individual while the ergative marked subject reflexive phrase refers only to one part of his/her personality. This example can also be viewed as representational—the person affected by his/her own TV-image. However, irrespective of how the referent of the postcedent is qualified—as affected by one of the aspects of his/her personality or by his/her TV image—it gets affected as an ordinary patient (cf. 33 vs. 36):

- (36) *prezident-ma damoḡvra part̄i-is lider-i.*  
 preident-ERG (s)he.instructed.him/her party-GEN leader-NOM  
 “The president instructed the party leader.”

Example 34 illustrates a context in which a recorded voice of a person helps him/her to recall the schedule for the next day. In this particular example a voice recording is a representation of that person affecting him/her just as an ordinary agent affects an addressee (cf. 34 vs. 37):

- (37) [*čem-i-ve xelkveit-i meubneba...*]  
 my-NOM-FOC subordinate-NOM (s)he.tells.me  
 “My own subordinate tells me...”

Example 35 illustrates a twin context where the referent of the reflexive phrase is not an aspect or image of the referent of the postcedent as it is in 33, 34 but it is a completely different personality closely resembling the referent of the postcedent. In 35 the reflexive phrase refers to the twin of the referent of the postcedent NP *natia-s*. It is as human and as agentive as the referent of the full NP *deda* in 38:

- (38) *deda ḡocnida natia-s.*  
 mother.NOM she.was.kissing.her Natia-dat  
 “The mother was kissing Natia.”

In these contexts the Georgian reflexive phrases refer to an image or a close associate which is not necessarily [-human]/[-animate] at all but can perform agentive behavior and act as an agent. In 33 and 34 the TV image of the party leader and the voice recording are in no way agentive. However, the referent of the postcedent gets affected by the images as an ordinary patient (cf. 33 vs. 36) or as an ordinary addressee (34 vs. 37). As for the twin context in Example 35, not only the referent of the postcedent gets affected as an ordinary patient (35 vs. 38) but also the referent of the reflexive phrase—the twin—performs an agentive behavior. One might call these cases non-anaphoric. However, as Jackendoff (1992) shows,

reflexive pronouns may in general be interpreted as referring to a representation of their antecedents and not only strictly identical to them.

Similar contexts like Mme. Tussaud's and Münchhausen's are discussed for Dutch in (Reuland, 2001). In both cases the complex anaphor *zichzelf* is interpreted as a representation of the antecedent (39b, 40b) while the simplex *zelf* as identical to it (39a, 40a). Both in 39b and 40b the SELF anaphor *zichzelf* expresses a relation between the antecedent and its function that bears a systematic resemblance to the antecedent, but can be distinguished from it.

(39) (Reuland, 2001, p. 483), Madame Tussaud context: Marie is famous and walked into Madame Tussaud's. She looked in a mirror and...

- a. ze zag zich in een griezelige hoek staan.  
she saw SE in a creepy corner stand  
"she saw herself standing in a creepy corner."
- b. ze zag zichzelf in een griezelige hoek staan.  
she saw herself in a creepy corner stand  
"she saw her statue standing in a creepy corner."

(40) Münchhausen context, (Reuland, 2001, p. 483)

- a. De baron trok zich uit het moeras.  
the baron pulled SE out of the swamp  
"The baron pulled himself out of the swamp." (by grabbing a branch of a tree hanging over him)
- b. De baron trok zichzelf uit het moeras.  
the baron pulled himself out of the swamp  
"The baron pulled himself out of the swamp." (by his hair)

Since the complex reflexive *zichzelf* is able to refer to objects which stand proxy to the antecedent and not be strictly identical to it, while the simplex *zich* cannot do so, Reuland (2001) interprets complex anaphors as a relevant function of the antecedent. For instance, the Frisian complex anaphor in 41a is interpreted as a function (41b) which maps the antecedent onto an object standing proxy for the antecedent.

(41) a. From (Reuland, 2001, p. 480)

Willem hatet himsels.  
"Willem hates himself."

b. Willem  $\lambda x$  (x hates f(x))

According to Reuland (2001), it is no accident that cross-linguistically the equivalent of *his head/soul/body/bone/eye/etc.* is a possible anaphor, and the equivalent of *his table* is not. Body-parts are inalienable nouns which in many languages can stand to refer to a person or objects which stand proxy to that person.

Therefore, it is possible to consider the semantics of body-part nouns to be responsible for interpreting them as a relevant function of the antecedent in reflexive constructions. The subject uses of the reflexive phrase in Georgian (headed by a body-part *tav-* “head”) which refer to an image of the postcedent (33, 34, 35) are a nice illustration of a complex reflexive to be interpreted as a function of the postcedent.

However, it is then again problematic to explain why the reciprocal *ertmanet-* in subject position (26a) gets the same interpretation as a reflexive phrase in subject position would have got (see, for instance, 10). The reciprocal in 26a is interpreted as an aspect/property of the referent of its postcedent but has no structure of inalienable anaphors (27).

## 8 Conclusion

The paper discusses the Georgian reflexive phrase as a subject argument of verbs in special contexts. Such contexts include a TV or mirror image, voice recording and twin contexts which illustrate the referent of the anaphor interpreted as an image/representation of the postcedent. The facts, although problematic both for the Binding Theory (Chomsky, 1981) and the Reflexivity Theory (Reinhart and Reuland, 1993), could in principle be accounted for by the analysis of complex anaphors as a relevant function of the antecedent, proposed in (Reuland, 2001). However, the Georgian reciprocal *ertmanet-*, being unable to get the same treatment as the Georgian reflexive phrase but, at the same time, being able to appear as a subject argument of verbs, makes the application of the analysis offered by Reuland (2001) to the Georgian data problematic.

## References

- Amiridze, Nino. 2003. The anaphor agreement effect and Georgian anaphors. In C. Beyssade, O. Bonami, P. Cabredo Hofherr and F. Corblin (eds.), *Empirical Issues in Formal Syntax and Semantics 4*, pages 99–114, Paris: Presses de l’Université de Paris-Sorbonne.
- Amiridze, Nino. 2004. On the *Aspect of Reading of Georgian Anaphors in Subject Position*. In J.-Y. Kim, Y. A. Lander and B. H. Partee (eds.), *Possessives and Beyond: Semantics and Syntax (University of Massachusetts Working Papers in Linguistics 29)*, pages 427–439, Amherst, MA: GLSA Publications.
- Amiridze, Nino and Everaert, Martin. 2000. On subject anaphora in Georgian, paper presented at the 10th Caucasian Colloquium, Munich, August 2-5, 2000.
- Anagnostopoulou, Elena. 1999. On experiencers. In A. Alexiadou, G. C. Horrocks and M. Stavrou (eds.), *Studies in Greek Syntax*, pages 67–93, Dordrecht: Kluwer.



- Anagnostopoulou, Elena and Everaert, Martin. 1999. Towards a more complete typology of anaphoric expressions. *Linguistic Inquiry* 30, 97–119.
- Anderson, Stephen R. 1984. On representations in morphology. Case, agreement and inversion in Georgian. *Natural Language and Linguistic Theory* 2(2), 157–218.
- Aronson, Howard I. 1994. Paradigmatic and Syntagmatic Subject in Georgian. In H. I. Aronson (ed.), *Non-Slavic Languages of the USSR. Papers from the Fourth Conference*, pages 13–33, Columbus Ohio: Slavica Publishers Inc.
- Artiagoitia, Xabier. 2003. Reciprocal and Reflexive Constructions. In J. I. Hualde and J. O. de Urbina (eds.), *A grammar of Basque*, pages 607–632, Berlin: Mouton de Gruyter.
- Asatiani, Rusudan. 1982. *martivi çinadadebis tipologiuri analizi* [Typological Analysis of Simple Sentence]. Tbilisi: Mecniereba, (in Georgian).
- Boeder, Winfried. 1989. Verbal person marking, noun phrases and word order in Georgian. In L. Marácz and P. Muysken (eds.), *Configurationality*, pages 159–184, Dordrecht: Foris.
- Chomsky, Noam. 1981. *Lectures on Government and Binding*. Dordrecht: Foris.
- Everaert, Martin. 2001. Paradigmatic restrictions on anaphors. In K. Meegerdooimian and L. A. Bar-el (eds.), *WCCFL 20 Proceedings*, pages 178–191, Somerville: Cascadilla Press.
- Everaert, Martin. 2003. Reflexivanaphern und Reflexivdomänen. In L. Gunkel, G. Müller and G. Zifonun (eds.), *Arbeiten zur Reflexivierung*, pages 1–23, Tübingen: Max Niemeyer Verlag.
- Harris, Alice C. 1981. *Georgian Syntax*. Cambridge: Cambridge University Press.
- Hewitt, George. 1995. *Georgian: A structural Reference Grammar*, volume 2 of *London Oriental and African Language Library*. Amsterdam and Philadelphia: John Benjamins.
- Iatridou, Sabine. 1988. Clitics, anaphors and a problem of coindexation. *Linguistic Inquiry* 19, 698–703.
- Jackendoff, Ray. 1992. Mme. Tussaud meets the binding theory. *Natural Language and Linguistic Theory* 10, 1–31.
- Kibrik, Aleksandr E. 1997. Beyond subject and object: Toward a comprehensive relational typology. *Linguistic Typology* 1, 279–346.
- Kvatchadze, Leo. 1996. *tanamedrove kartuli enis sintaksi* [Syntax of Modern Georgian]. Tbilisi: Rubikoni, (in Georgian).

- Ljutikova, Ekaterina. 1999. Bez Podležaščix i Dopolnenij: Refleksivizacija v Bagvalinskom Jazyke [Without subjects and objects: Reflexivization in Bagwalal]. In E. V. Rakhilina and Y. G. Testelec (eds.), *Tipologija i Teorija Jazyka*, Moscow: Jazyki Russkoj Kul'tury, (in Russian).
- Reinhart, Tanya and Reuland, Eric. 1993. Reflexivity. *Linguistic Inquiry* 24, 657–720.
- Reuland, Eric. 2001. Primitives of Binding. *Linguistic Inquiry* 32(3), 439–492.
- Reuland, Eric and Everaert, Martin. 2001. Deconstructing Binding. In M. Baltin and Ch. Collins (eds.), *Handbook of Syntactic Theory*, pages 634–670, London: Blackwell.
- Shanidze, Akaki. 1973. *kartuli enis gramaṭikis sapuzvlebi* [*Foundations of Georgian Grammar*]. Tbilisi: Tbilisi University Press, (in Georgian).

# Reflexives: Escaping exemption via domain reshuffling

António Branco 

University of Lisbon

Proceedings of the 12th International Conference on  
Head-Driven Phrase Structure Grammar

Department of Informatics, University of Lisbon

Stefan Müller (Editor)

2005

Stanford, CA: CSLI Publications

pages 467–481

Branco, António. 2005. Reflexives: Escaping exemption via domain reshuffling. In Stefan Müller (ed.), *Proceedings of the 12th International Conference on Head-Driven Phrase Structure Grammar, Department of Informatics, University of Lisbon*, 467–481. Stanford, CA: CSLI Publications. DOI: 10.21248/hpsg.2005.27.



## Abstract

In this paper we argue that at least for some languages, when there are suitable o-commanders of its selectional domain, a reflexive in the bottom of its obliqueness hierarchy escapes exemption via a reshuffling of its local binding domain. The outcome of such reshuffling is that the local domain extends to include o-commanders of the reflexive in the subcategorization domain immediately upstairs, that is in the domain whose head predicator directly subcategorizes the domain headed by the predicator directly subcategorizing the reflexive.

## 1 Introduction

Anaphors depend on other expressions, their antecedents, to be interpreted, and the set of admissible antecedents for a given anaphor has been shown to comply with parameterized cross-language invariants, which are captured in generalizations usually known under the designation of binding principles. These invariants permit to group together anaphors that, in the same contexts of occurrence, have the same set of admissible antecedents, thus inducing a partition of anaphors according to their anaphoric capacity.

### 1.1 Reflexives

Reflexives belong to one of such classes of anaphors. They comply with the generalization captured in binding Principle A, if they are of a short-distance nature — like the English *himself* —, or with binding Principle Z, if they are of a long-distance sort — like the Portuguese *ele próprio*:

- (1) Principle A: A short-distance reflexive is locally o-bound.  
Principle Z: A long-distance reflexive is o-bound.

The definition of Principle A above is an abbreviated rendering of the empirical generalization that admissible antecedents of a short-distance (SD-) reflexive are the expressions that are immediately, or directly, selected by the predicator immediately selecting the reflexive and have a grammatical function that is less oblique than the grammatical function of the reflexive —

where, for instance, Subject is less oblique than Object or Indirect Object, Object is less oblique than Indirect Object, etc.

This verbose rendering of Principle A is obtained when the auxiliary notions used in the definitions above are unfold: A o-binds B abbreviates that A and B are coindexed and A o-commands B. A and B are coindexed is an abbreviation for the fact that the expression that is the anaphor, A resp. B, takes the other, B resp. A, as its antecedent. A o-commands B abbreviates that A is less oblique than B if they are selected by the same predicator, or A o-commands some X that subcategorizes for Z or is a projection of Z. These relations are transitive and are specialized to a "local" version when A and B are immediately, or directly, selected by the same predicator (cf. Pollard and Sag, 1994).

The following example illustrates these constraints at work for SD-reflexives:

- (2) The judge<sub>j</sub> thinks [ that [Kim's<sub>k</sub> lawyer]<sub>l</sub> described himself<sub>\*j/\*k/l/\*w</sub> to the witness<sub>w</sub> ].

The expressions *the judge* and *Kim* do not qualify as admissible antecedents of *himself* as they are not immediately selected by the predicator *described*, that immediately selects the reflexive: *the judge* is not selected by *described*; *Kim* is selected by this predicator but not immediately, given it is part of its Subject, i.e. part of *Kim's lawyer*. And *the witness*, though being immediately selected by *described*, is ruled out from being an admissible antecedent for it because it is more oblique than the reflexive.

The definition of Principle Z, in turn, can be seen as resulting from the definition of Principle A by removing the locality restriction from it. Accordingly, expressions outside the local binding domain of a long-distance (LD-) reflexive, but selected by a predicator that mediately selects the constituent headed by the predicator directly selecting this reflexive are admissible antecedents of it. The critical difference between LD- and SD-reflexives in terms of their anaphoric capacity is captured by the contrast between the examples in (2) and (3). In the example below, from Portuguese, the Subject of the main clause, which is outside the local binding domain of the reflexive *ele próprio*, is also an admissible antecedent for it:

- (3) O juiz<sub>j</sub> pensa [ que [o advogado do Bruno<sub>k</sub>]<sub>l</sub> gosta dele próprio<sub>\*j/\*k/l</sub> ].  
 the judge<sub>j</sub> thinks [ that [ the lawyer of<sub>the</sub> Bruno<sub>k</sub> ]<sub>l</sub> likes of<sub>ELE</sub> PRÓPRIO<sub>\*j/\*k/l</sub> ]  
*The judge<sub>j</sub> thinks that Bruno's<sub>k</sub> lawyer<sub>l</sub> likes him<sub>j</sub>/himself<sub>l</sub>.*

## 1.2 Exemption

In the research on binding principles, in general, and on the anaphoric capacity of reflexives, in particular, an important breakthrough was the realization that, in a well-defined, specific set of occurrences, reflexives may be exempt from following their typical anaphoric binding invariant, as in all their other remaining occurrences, and captured in Principles A and Z. Such notion of exemption is a key contribution of Pollard and Sag (1992, 1994), developed on the basis of data concerning short-distance reflexives, and subsequently shown by Branco and Marrafa (1999) and Branco (2000) to extend also to long-distance reflexives. It can be rendered as follows: LD-reflexives, resp. SD-reflexives, are exempt from their typical anaphoric binding discipline when they occur in the beginning of their o-command hierarchy, resp. of their local o-command hierarchy (for the purpose of ease of reference, let us call such positions o-bottom positions).

The following two examples illustrate reflexives in o-bottom positions and the associated exemption effect:

- (4) a. John<sub>i</sub> was going to get even with Mary. That picture of himself<sub>i</sub> in the paper would really annoy her, as would the other stunts he had planned.
- b. O Bruno<sub>i</sub> estava contente. A foto que ele próprio<sub>i</sub> tirou apareceu na primeira página do jornal.  
the Bruno<sub>i</sub> was happy. The picture that ELE PRÓPRIO<sub>i</sub> took appeared in\_the first page of\_the newspaper  
*Bruno<sub>i</sub> was happy. The picture he<sub>i</sub> took appeared in the newspaper's front page.*

In (4)a. (=Pollard and Sag, 1994:p.270,(94)), the SD-reflexive *himself* is the only argument of *picture*, the (nominal) predicator selecting it, and therefore in an o-bottom position; in (4)b., the LD-reflexive *ele próprio* is also the only argument of *foto*, which heads the Subject of the main clause, and henceforth is also in an o-bottom position. In both cases, the reflexives do not display their typical anaphoric binding discipline, and take antecedents that are ruled out by binding principles in (1).

Besides their specific anaphoric binding discipline captured by the definitions in (1), as part of their intrinsic anaphoric capacity, an overarching interpretability condition is admittedly in force in natural languages requiring the “meaningful” anchoring of reflexives to antecedents. When reflexives are in o-bottom positions, an o-commander is not available to function as antecedent and anchor their interpretation. Hence, the specific binding constraints, viz. Principle A and Z, cannot be satisfied in a “meaningful” way and the general interpretability requirement may supervene them. As a consequence, in cases like (4), displaying so-called exemption, o-bottom

reflexives appear to escape their specific binding regime to comply simply with such general requirement and their interpretability be rescued.

In order to accommodate the possibility of exemption from their typical binding discipline in o-bottom positions, the binding principles for reflexives have thus been more accurately rendered in the following extended definition:

- (5) Principle A: A locally o-commanded short-distance reflexive is locally o-bound.

Principle Z: An o-commanded long-distance reflexive is o-bound.

### 1.3 The issue

Since the notion of exemption was established, an interesting issue that calls for further research is whether o-bottom reflexives, while being exempt from their typical anaphoric discipline, might still display any substantial grammatical regularity with respect to the distribution of their admissible antecedents: In short, whether some other binding invariant might still come into play for reflexives exempt from their core anaphoric capacity, as this is captured by the binding principles above.

A thorough scrutiny of this issue faced certain initial methodological obstacles among which is the fact that the distribution of reflexives in the most studied language, English, is restricted by its non-nominative case marking, which hampers the testing of their anaphoric behavior in exempt sentential Subject positions. Moreover, the data available for exempt reflexives in English picture NPs and nominal predication structures in general seemed, in turn, to indicate that the possible factors impinging on the anaphoric capacity of o-bottom reflexives to be more of a soft, discourse-based character (Zribi-Hertz, 1989; Golde, 1999), than of the hard, grammatical nature of binding principles.

Against this background, my goal in this paper is to explore new data contributing new insights concerning this issue. By fully exploring the account briefly hinted at in Branco (2005), I argue that the data presented and discussed below are better explained as supporting the view that o-bottom reflexives may obey a hard, grammatical anaphoric discipline.

In more concrete terms, my claim is that, at least for some languages, o-bottom reflexives are not exempt but keep being ruled by their corresponding binding principle. This holds provided that a very simple hypothesis is entertained: For such reflexives, in the bottom of their obliqueness hierarchy, the relevant local domain reshuffles to include the o-commanders in the selectional domain immediately upstairs, that is the selectional domain which immediately dominates the selectional domain in whose o-bottom position the reflexive occurs.

In the next Section 2, I present data concerning the Portuguese third person null Subject that help to uncover its anaphoric properties. In opposition to a widespread and unchallenged assumption that takes this null Subject as a pronoun (cf., among many others, Barbosa, 1995, Mateus *et al.*, 2003), my claim is that this null anaphor is actually not a pronoun but rather a reflexive. In particular, and more importantly for the point of the present paper, this null anaphor is an o-bottom reflexive inducing the reshuffling of its local binding domain.

In Section 3, I discuss data concerning an overt SD-reflexive in o-bottom positions from another language, viz. the German reflexive *sich*, and argue that this reflexive also induces local binding domain reshuffling.

Finally, in the last Section 4, I summarize the discussion and claims presented in this paper, and underline relevant research lines opened by the results obtained here.

## 2 Portuguese null subjects

The data to be analyzed in this Section are from Portuguese anaphors occurring in o-bottom positions for the purpose of the anaphoric binding constraints on reflexives. They critically involve the phonetically null third person anaphor occurring in the Subject position of finite sentences.

Null Subjects in Portuguese, and in other so-called pro-drop languages, have been under intensive analysis in the literature. The focus here, however, is not on the discussion of the possible factors licensing their occurrence, but rather on the much less explored research path of thoroughly inspecting their anaphoric capacity and the binding discipline which they comply with.

### 2.1 Apparent non-locality

A null Subject may pick an antecedent outside its local domain, as illustrated in the example below:

- (6) O Bruno<sub>i</sub> pensa [ que Ø<sub>i</sub> será convidado para a festa ].  
 the Bruno<sub>i</sub> thinks [ that Ø<sub>i</sub> will<sub>be</sub> invited to the party ]  
*Bruno<sub>i</sub> thinks that he<sub>i</sub> will be invited to the party.*

In this respect, it displays an anaphoric behavior similar to the behavior of overt pronouns, as can be seen from the comparison between (6) and (7):

- (7) O Bruno<sub>i</sub> pensa [ que ele<sub>i</sub> será convidado para a festa ].  
 the Bruno<sub>i</sub> thinks [ that he<sub>i</sub> will<sub>be</sub> invited to the party ]  
*Bruno<sub>i</sub> thinks that he<sub>i</sub> will be invited to the party.*



This comparison has been iterated in the literature and has been the empirical basis supporting the assumption that null Subjects are pronouns, thus following the corresponding anaphoric binding invariant, collected in binding Principle B:

- (6) Principle B: A pronoun is locally o-free.

Nevertheless, from the perspective of its anaphoric binding capacity, the possibility of picking an antecedent outside its local domain is the only feature that a null Subject apparently share with pronominals. As a matter of fact, when going through the critical criteria to ascertain that an anaphor is a reflexive, all of them are met by this null anaphor in the Subject position.

In what follows, such criteria are going to be positively tested.

## 2.2 Locality regained

First, the null anaphor does obey a locality restriction, though not of the usual kind in core cases of non o-bottom reflexives:

- (9) A Ana<sub>i</sub> pensa [ que a Rita<sub>j</sub> me disse [ que  $\emptyset_{*i/j}$  será convidada para a festa ] ].  
 the Ana<sub>i</sub> thinks [ that the Rita<sub>j</sub> to<sub>me</sub> told [ that  $\emptyset_{*i/j}$  will<sub>be</sub> invited to the party ] ]  
*Ana<sub>i</sub> thinks that Rita<sub>j</sub> told me that she<sub>j</sub> will be invited to the party.*

In (9), *a Rita* can be an antecedent of the null anaphor, but *a Ana* cannot. While *a Rita* is inside the local domain circumscribed by the verb that immediately selects the clause where the null anaphor is, *a Ana* is outside that local domain. The anaphor cannot thus reach beyond the immediately upstairs domain for admissible antecedents, as a pronoun can do, in a construction forming a minimal pair with (9):

- (10) A Ana<sub>i</sub> pensa [ que a Rita<sub>j</sub> me disse [ que ela<sub>i/j</sub> será convidada para a festa ] ].  
 the Ana<sub>i</sub> thinks [ that the Rita<sub>j</sub> to<sub>me</sub> told [ that she<sub>i/j</sub> will<sub>be</sub> invited to the party ] ]  
*Ana<sub>i</sub> thinks that Rita<sub>j</sub> told me that she<sub>i/j</sub> will be invited to the party.*

Such an impossibility of reaching beyond the immediately upstairs domain holds, even more clearly, also in constructions where there is no admissible antecedent intervening between the null anaphor and the expressions outside that upstairs domain:

- (11) A Ana<sub>i</sub> pensa [ que nenhuma revista anunciará [ que ela/\* $\emptyset$ <sub>i</sub> será convidada para a festa ] ].  
 the Ana<sub>i</sub> thinks [ that no magazine will<sub>announce</sub> [ that she/\* $\emptyset$ <sub>i</sub> will<sub>be</sub> invited to the party ] ]  
*Ana<sub>i</sub> thinks that no magazine will announce that she<sub>i</sub> will be invited to the party.*

Contrasts like the one in (9) or (11), indicating that the admissible antecedents of the o-bottom null anaphor are to be found in the local domain immediately upstairs can be multiplied at ease with different syntactic structures.

In (12), the null anaphor is the Subject of the embedded clause in the adverbial clause. It cannot have *o Bruno* as antecedent, which lies outside the local domain immediately upstairs, circumscribed by the predicator heading the adverbial clause:

- (12) O Bruno não vai às festas [ quando a Ana decide [ que ele/\* $\emptyset$ <sub>i</sub> será o convidado de honra ] ].  
 the Bruno not goes to the parties [ when the Ana decides [ that he/\* $\emptyset$ <sub>i</sub> will<sub>be</sub> the guest of honor ] ]  
*Bruno<sub>i</sub> doesn't go to parties when Ana decides that he<sub>i</sub> will be the guest of honor.*

In (13), the null anaphor is in the Subject position of the relative clause (the pied piping of the preposition *de*, subcategorized for by the verb *gostar*, hampers this clause to be alternatively interpreted as a Subject relative as well). It cannot have *a Ana* as antecedent, which lies outside the local (nominal) domain immediately upstairs.

- (13) O Bruno apresentou a Ana<sub>i</sub> [ ao amigo [ de quem ela/\* $\emptyset$ <sub>i</sub> gosta ] ].  
 the Bruno introduced the Ana<sub>i</sub> [ to<sub>the</sub> friend [ of who she/\* $\emptyset$ <sub>i</sub> likes ] ]  
*Bruno introduced Ana<sub>i</sub> to the friend who she<sub>i</sub> likes.*

### 2.3 Recess opacity

Second, like what happens to overt reflexives, recesses in the geometry of grammatical representation are opaque to the anaphoric capacity of the null anaphors.

As the example above shows, *o Bruno* is not an admissible antecedent of *si próprio* as an expression cannot not o-command the overt reflexive to qualify as its antecedent:

- (14) [ O advogado do Bruno<sub>i</sub> ]<sub>j</sub> apresentou-se a si próprio<sub>\*i/j</sub> .  
 [ the lawyer of<sub>the</sub> Bruno<sub>i</sub> ]<sub>j</sub> introduced-SE to SI PRÓPRIO<sub>\*i/j</sub> .  
*Bruno's<sub>i</sub> lawyer<sub>j</sub> introduced himself<sub>j</sub>.*

This pattern is also observed in constructions with null Subjects, even if the antecedent candidate is inside of arguments in the domain immediately upstairs:

- (15) \* [ A namorada do Bruno<sub>i</sub> ] disse que Ø<sub>i</sub> será convidado para a festa.  
 [ the girlfriend of<sub>the</sub> Bruno<sub>i</sub> ] said that Ø<sub>i</sub> will<sub>be</sub> invited to the party  
*Bruno<sub>i</sub>'s girlfriend said that he<sub>\*i</sub> will be invited to the party.*

## 2.4 Directionality

Third, given their admissible antecedents cannot not o-command them, an overt reflexives follows also a directionality constraint. This is exemplified below, where the Direct Object can be an antecedent of the more oblique Indirect Object reflexive, as exemplified in (a.), but not vice-versa, as exemplified in (b.):

- (16) a. O Bruno descreveu a Ana<sub>i</sub> a si própria<sub>i</sub>.  
 the Bruno described the Ana<sub>i</sub> to SI PRÓPRIA<sub>i</sub>  
*Bruno described Ana<sub>i</sub> to herself<sub>i</sub>.*  
 b. O Bruno descreveu(-se a) si própria<sub>\*i</sub> à Ana<sub>i</sub>.  
 the Bruno described(-SE to) SI PRÓPRIA<sub>\*i</sub> to<sub>the</sub> Ana<sub>i</sub>  
*Bruno described herself<sub>\*i</sub> to Ana<sub>i</sub>.*

Likewise, admissible antecedents cannot not o-command it.

In the example below, the Direct Object complement *a Ana* is less oblique than the Oblique complement introduced by the preposition *de*, the embedded clause containing the null anaphor, and a fortiori an o-commander of this anaphor itself. The anaphoric relation is possible here:

- (17) O Bruno informou a Ana<sub>i</sub> de [ que  $\emptyset$ <sub>i</sub> será convidada para a festa ].  
 the Bruno informed the Ana<sub>i</sub> of [ that  $\emptyset$ <sub>i</sub> will\_be invited to the party ]  
*Bruno informed Ana<sub>i</sub> that she<sub>i</sub> will be invited to the party.*

However, in the example below, the Oblique complement *a Ana* is o-commanded by the Direct Object complement, which is the embedded clause containing the null anaphor, and *a fortiori* is not an o-commander of this anaphor. The anaphoric relation, in turn, is not possible here:

- (18) O Bruno combinou com a Ana<sub>i</sub> que ela/\* $\emptyset$ <sub>i</sub> vai telefonar-lhe antes da festa.  
 the Bruno planned with the Ana<sub>i</sub> that she/\* $\emptyset$ <sub>i</sub> goes to\_call-him before of\_the party  
*Bruno planned with Ana<sub>i</sub> for her<sub>i</sub> to call him before the party.*

## 2.5 Split antecedents

Fourth, Portuguese long-distance reflexives tend to be slightly less resistant to split antecedents than their cousin short-distance reflexives. Compare (19)(a). to (16) above:

- (19) a. \* O Bruno<sub>i</sub> descreveu a Ana<sub>j</sub> a si próprios<sub>i+j</sub>.  
 the Bruno described the Ana to SI PRÓPRIOS<sub>i+j</sub>  
*Bruno<sub>i</sub> described Ana<sub>j</sub> to themselves<sub>i+j</sub>.*  
 b. ? O Bruno<sub>i</sub> descreveu a Ana<sub>j</sub> a eles próprios<sub>i+j</sub>.  
 the Bruno<sub>i</sub> described the Ana<sub>j</sub> to ELES PRÓPRIOS<sub>i+j</sub>  
*Bruno<sub>i</sub> described Ana<sub>j</sub> to themselves<sub>i+j</sub>.*

In what concerns split antecedents, the null anaphor seems to go along more with long-distance reflexives than with short-distance ones:

- (20) ? O Bruno<sub>i</sub> informou a Ana<sub>j</sub> de que  $\emptyset$ <sub>i+j</sub> serão convidados para a festa.  
 the Bruno<sub>i</sub> informed the Ana<sub>j</sub> of that  $\emptyset$ <sub>i+j</sub> will\_be invited to the party  
*Bruno informed Ana<sub>i</sub> that they<sub>i+j</sub> will be invited to the party.*

## 2.6 Extra-sentential anaphora

Fifth, a pronoun admits deictic usage (represented with the index  $x$  in the example below) and anaphoric resolution to antecedents outside its sentence, but a reflexive does not:

- (21) O Bruno<sub>i</sub> estava contente. A Ana disse que ela gosta de \*si próprio/dele<sub>i/x</sub>.  
the Bruno<sub>i</sub> was happy. the Ana said that she likes of \*SI PRÓPRIO/of\_him<sub>i/x</sub>.  
*Bruno<sub>i</sub> was happy. Ana said she likes him<sub>i/x</sub>.*

The null anaphor patterns with the reflexives in this respect:

- (22) O Bruno<sub>i</sub> estava contente. A Ana decidiu que  $\emptyset$ \*i/\*x será o próximo convidado de honra.  
the Bruno<sub>i</sub> was happy. the Ana decided that  $\emptyset$ \*i/\*x will be the next guest of honor.  
*Bruno<sub>i</sub> was happy. Ana decide he<sub>i/x</sub> will be the next guest of honor.*

## 2.7 Exemption

Finally, like overt reflexives, the null anaphor may be exempt from its typical binding discipline.

The example below illustrate the exempt behavior of the LD-reflexive *ele próprio*. When in o-bottom position, it can entertain cross-sentential anaphoric links:<sup>1</sup>

- (23) A: Como é que o Bruno<sub>i</sub> resolveu o problema?  
B: Ele próprio<sub>i</sub> foi falar com o director.  
A: *How did Bruno<sub>i</sub> solve the problem?*  
B: *He<sub>i</sub> talked with the manager.*

The exempt behavior of the null anaphor is observed when local domain reshuffling is not available, that is when no upstairs selectional domain exists

---

<sup>1</sup> Note that the Portuguese SD-reflexive *si próprio* does not occur in nominative positions, so it cannot be checked in the contexts relevant for the point discussed in this section.

and the null anaphor is in absolute o-bottom position. In such cases, the null anaphor may accept extra-sentential antecedents:

- (24) A: O que é que o Bruno<sub>i</sub> fez ontem?  
B: Ø<sub>i</sub> Foi ao cinema.  
A: *What did Bruno<sub>i</sub> do yesterday?*  
B: *He<sub>i</sub> went to the movies.*

This construction should be contrasted with the data in (22), where the null anaphor is not in absolute o-bottom position and exemption is therefore not an option.

## 2.8 Analysis

The empirical evidence worked out above can be straightforwardly explained if one simply assumes that: On the one hand, the Portuguese null anaphor is a reflexive (which, due to reasons possibly orthogonal to its anaphoric capacity, occurs in Subject position); and in the other hand, given it occurs in Subject positions, i.e. in o-bottom positions of local obliqueness hierarchies, if it is not in the matrix clause, its local domain is reshuffled to include the o-commanders in the selectional domain upstairs that immediately dominates the selection domain where it directly occurs.

Therefore, in order to account for the data below, we just need to minimally expand our set of theoretical constructs with the addition of the following very simple hypothesis: the reshuffling of local binding domains for o-bottom reflexives is possible (and it is possibly a parameterizable feature across languages).

All the data below can then be straightforwardly understood by simply:

- (i) classifying the Portuguese null anaphor as a reflexive;
- (ii) assuming that Portuguese allows local domain reshuffling.

## 3 German o-bottom reflexives

In order to reinforce its empirical strength, this analysis calls to be further explored into several directions. The most critical ones are certainly concerned with how it possibly extends to:

- (i) other languages;
- (ii) reflexives of a more "usual" kind: overt reflexives that may occur in non Subject positions as well.

Data indicating that local domain reshuffling is possible in other languages, from other language family, with overt reflexives in non Subject

position, can be obtained with examples involving the German short-distance reflexive *sich*.

First, when in an o-bottom position (which however is not a clausal Subject position), admissible antecedents for *sich* can be found only in the immediately upstairs local domain (Tibor Kiss, p.c.):

- (25) Gernot<sub>i</sub> dachte, [ dass Hans<sub>j</sub> dem Ulrich [ ein Bild von sich<sub>\*i/j</sub> ] überreichte ].  
Gernot<sub>i</sub> thought that [ Hans<sub>j</sub> the Ulrich [ a picture of SICH<sub>\*i/j</sub> ] gave  
*Gernot<sub>i</sub> thought that Hans<sub>j</sub> gave Ulrich a picture of himself<sub>j</sub>.*

Second, even in a reshuffled local domain, directionality of anaphoric binding for reflexives is complied with, as a non o-commander in the domain immediately upstairs is not an admissible antecedent (Kiss (2001):(8)a):

- (26) Ich überreichte dem Ulrich<sub>i</sub> ein Buch über sich<sub>\*i</sub>.  
I gave the Ulrich a book about SICH<sub>\*i</sub>  
*I gave a book about himself<sub>\*i</sub> to Ulrich<sub>i</sub>.*

Third, even in a reshuffled local domain, recesses in grammatical geometry are opaque to the anaphoric capacity of *sich*, as a nominal inside of an o-commanding nominal is not an admissible antecedent for it (Manfred Sailer, p.c.):

- (27) Jan dachte, dass [ die Mutter von Hans<sub>i</sub> ] dem Carl [ ein Bild von sich<sub>\*i</sub> ] überreichte.  
Jan thought that [ the mother of Hans<sub>i</sub> ] the Carl [ a picture of SICH<sub>i</sub> ] gave ]  
*Jan thought that Hans'<sub>i</sub> mother gave Ulrich a picture of himself<sub>\*i</sub>.*

Accordingly, the above data on the German reflexive *sich* fall into place with just the simple hypothesis that the German permits local binding domain reshuffling when reflexives occur in o-bottom positions of embedded predication domains.

In our view, this is an improvement with respect to the account proposed in Kiss (2001), as it dispenses with an extra notion of o-binding (e.g. minimal o-binding), with a revised version of Principle A — which turns out to break the symmetry with Principle B and to be somewhat sloppy —, and above all with the setting of parameter values in a complex parameter space (2x3) for which almost all combinations of values are supported by very sparse data in the literature or are not empirically attested at all.

## 4 Conclusions and outlook

A major result contributed by this paper is that the local binding domain of reflexives can be reshuffled.

The data worked out in the present paper support the claim that, at least in Portuguese and German, though in o-bottom positions, when a reshuffling of their local domains is possible, reflexives turn out not to be exempt from their typical anaphoric binding discipline, as this is captured in the definition of binding Principles A and Z. In such circumstances, the reflexives escape exemption via a reshuffling of their local domain.

The outcome of such reshuffling is that, for a reflexive in the bottom of the obliqueness hierarchy induced by the predicator directly subcategorizing it, its local binding domain reshuffles to include its o-commanders in the subcategorization domain immediately upstairs (if such upstairs domain exists, of course). The subcategorization domain immediately upstairs is the domain whose head predicator directly subcategorizes the domain headed by the predicator directly subcategorizing the reflexive, and the upstairs o-commanders entering the reshuffled local domain of the reflexive are the arguments in the upstairs domain that are less oblique than the domain where the reflexive immediately occurs.

Another important result contributed by the present paper concerns the anaphoric capacity of Portuguese third person null Subjects in finite clauses. In the literature, the pervasive and ever unchallenged view is that, with respect to binding classes of anaphors, this anaphor is to be classified as a null pronoun. In this paper, we showed that this view is not supported by the scrutiny of the anaphoric capacity of this null expression. Not only its anaphoric behavior does not pattern with the anaphoric behavior of pronouns, as instead it satisfies all the tests that can be made in order to check its reflexive nature. The Portuguese third person null Subject in finite clauses was thus shown to be a reflexive.

As the data supporting the result that Portuguese null Subjects are reflexives may turn out to be replicated with respect to null Subjects also in other languages, it may be a future key contribution to eventually show that the long studied null anaphor, typically licensed by strong verbal morphology and also known as little pro in some grammar frameworks, is not a pronoun after all, but rather a reflexive.

## Acknowledgments

I am very grateful to Tibor Kiss and Manfred Sailer for their help with the German data. I am the sole responsible for remaining errors.



## References

- Barbosa, 1995, *Null Subjects*. Ph.D. dissertation. MIT, Cambridge, Mass.
- Branco, 2005, "Anaphoric Constraints and Dualities in the Semantics of Nominals", *Journal of Logic, Language and Information*, **14**, 149-171.
- Branco, 2000, *Reference Processing and its Universal Constraints*, Lisbon: Edições Colibri.
- Branco and Marrafa, 1999, "Long-distance Reflexives and the Binding Square of Opposition", In Weibelhuth, Koenig and Kathol (eds.), *Lexical and Constructional Aspects of Linguistic Explanation*, Stanford: CSLI Publications, 163-177.
- Golde, 1999, *Binding Theory and Beyond*, PhD dissertation, Ohio: The Ohio State University.
- Kiss, 2001, "Anaphora and Exemptness. A comparative treatment of anaphoric binding in German and English. In Flickinger and Kathol, (eds.), *The Proceedings of the 7th International Conference on Head-Driven Phrase Structure Grammar*. Stanford: CSLI Publications, 182-197.
- Mateus, Brito, Duarte, Faria, Frota, Matos, Oliveira, Vigário and Villalva, 2003, *Gramática da Língua Portuguesa*, Lisbon, Caminho.
- Pollard and Sag, 1992, "Anaphors in English and the Scope of Binding Theory", *Linguistic Inquiry*, **23**, 261-303.
- Pollard and Sag, 1994, *Head-Driven Phrase Structure Grammar*, Stanford: CSLI Publications.
- Zribi-Hertz, 1989, "Anaphor Binding and Narrative Point of View: English Reflexive Pronouns in Sentence and Discourse", *Language*, **65**, 695-727.

# Phases and binding of reflexives and pronouns in English

Réjean Canac-Marquis

Simon Fraser University

Proceedings of the 12th International Conference on  
Head-Driven Phrase Structure Grammar

Department of Informatics, University of Lisbon

Stefan Müller (Editor)

2005

Stanford, CA: CSLI Publications

pages 482–502

Canac-Marquis, Réjean. 2005. Phases and binding of reflexives and pronouns in English. In Stefan Müller (ed.), *Proceedings of the 12th International Conference on Head-Driven Phrase Structure Grammar, Department of Informatics, University of Lisbon*, 482–502. Stanford, CA: CSLI Publications. DOI: 10.21248/hpsg.2005.28.



## Abstract<sup>†</sup>

This paper proposes a distinct approach to local binding effects for reflexives and pronominals in English whereby the nature of local binding domains is a by-product of the incremental interpretation of syntactic derivations (Uriageraka 1999, Chomsky 2000, 2001), emphasizing the role of the Conceptual /Intentional interface and the computational system (i.e. bare output conditions) in shaping general principles of grammars. A significant development of the Minimalist framework is the proposal that derivations operate through *phases* or multiple spell outs, which allows to reduce the strict cyclicity of derivations, and related locality effects of movement, to interface (bare output) conditions and economy conditions. In this paper I propose that incremental interpretation can further capture local binding domains effects of conditions A and B of Chomsky's (1981, 1986) Binding Theory. Basically, local binding domains are shown to correspond to "accessible phase domains". Our proposal hence contrasts with standard analyses (e.g. Reinhart and Reuland 1993, Pollard and Sag 1992) that define co-argumenthood as the core factor from which binding conditions are developed. Our proposal also provides a new perspective on the core contrasts between A-chain and A-bar chain w.r.t. binding and scope reconstruction effects and argues that checking of the uninterpretable feature Case is what defines potential phase domains.

### 1. Case and Phase

For Chomsky (2001, 2001), a phase is a syntactic object defined as a domain for cyclic interpretation. While Chomsky identifies vP and CP as phases, other categories have been identified as phases in the literature: DPs (Adger 2003); ApplP (McGinnis 2004); M-Domains and N-domains for morphology (DiSciullo 2003). A core proposal of this paper is that uninterpretable feature checking, Case in particular, defines a phase domain and makes DPs, AgrPs (or AspectP or ApplP), PPs and TPs potential phases. The reason why Case plays such a central role actually follows naturally from basic assumptions of the Minimalist Program. As an uninterpretable feature, Case must delete before spell out to avoid a derivation from crashing. Case-checking points

---

<sup>†</sup> I wish to thank my colleagues in the *Interface* project for their comments at the early stage of this paper, in particular: Anne-Maria Di Sciullo, Rosemary Déchaine, Yves Roberge, Virginia Hill and Manuel Espanol Echevaria. I also thanks comments from the audience at the CLA meeting at UWO, the IPSI conference in Pescara (Italy) and the HPSG/Binding Workshop in Lisbon. Research Funding for this paper was partly provided by the MCRI SSHRC grant #412-2003-1003 *Interface Asymmetries and Cognitive Treatments* directed by Anne-Maria Di Sciullo (UQAM); VP-Research and FASS Dean's office, Simon Fraser University.

must therefore correspond to the earliest phase spell out points that a derivation must reach. In particular for DPs, their case checking position in a derivation is the earliest point at which they can enter LF through spell out. This would effectively make case-checking categories, such as AgrP, TP, ApplP and PPs potential categorical phases and potential entry points of DPs at LF. If this is one the right track, we should hope to find evidence that DPs are not semantically active prior to those entry points and in turn, that they crucially are semantically active at those very points.

As it turns out, there is interesting evidence supporting that prediction. It is widely recognized that A-chains and A-bar Chains display a number of asymmetries or mirroring properties w.r.t. binding and scope reconstruction effects. In addition, the relative boundaries of argument A-chains and A-bar chains is precisely defined by Case: Case is always at the head of an argument A-chain and at the tail of an argument A-bar Chain, i.e. Case defines the upper and lower boundaries of argument A-chains and A-bar Chains, respectively. These two generalizations are no coincidence under our analysis. As we argue directly, those asymmetries indicate that DPs are semantically inert before the case checking point, while being active at and arguably, not beyond that same entry point. As such, they directly support our proposal that Case-checking defines potential phase categories and sets the transitional boundaries of A-chains and A-bar Chains, i.e. the minimal point at which a DP transits to LF and becomes semantically active.

## 1.2 Case Phase and Mirroring Properties of Chains

Let us now consider those mirroring properties in details, in light of our analysis. The mirroring properties are summarized in (1) for A-chains and (2) for A-bar chains.

### (1) A-chains

- a. Feed A-Binding:  
John<sub>i</sub> seems to himself [e<sub>i</sub> to be happy]
- b. No Binding Reconstruction (Chomsky 1995:210)  
[That John<sub>i</sub> was asleep]<sub>j</sub> seems to him<sub>i</sub> [e<sub>j</sub> to be correct]
- c. No Scope reconstruction (Lasnik 2003: 134)  
[no one]<sub>i</sub> is certain e<sub>i</sub> to solve the problem  
# it is certain that no one solved the problem
- d. No WCO effect:  
Who<sub>i</sub> seems to his<sub>i</sub> mother [ e<sub>i</sub> to be intelligent]

(2) **A-bar chains**

- a. Do not feed A-Binding:  
\*Who<sub>i</sub> does [each other<sub>i</sub>'s supporters] like e<sub>i</sub>
- b. Binding Reconstruction  
\*[Which portrait of John<sub>i</sub>]j does he<sub>i</sub> prefer e<sub>i</sub>
- c. Scope Reconstruction:  
This man, some picture of whom everyone knows
- d. WCO effect:  
?\*Who<sub>i</sub> does [his<sub>i</sub> supporters] like e<sub>i</sub>

These properties have been much discussed in the literature, and some more recently in Chomsky (1995) and Lasnik (2003), but no single explanation seems able to capture the striking mirroring behavior that A-chains and A-bar chains have w.r.t. various binding and scope reconstruction phenomena. Hence (1a) and (2a) contrast directly in that only the head of an A-chain can feed A-binding. Under our proposal, the DP becomes active at the head of the A-chain where Case is checked, and not before. In addition, it seems that this entry point is actually fixed insofar as A-binding is concerned: the (maximal) C-commanding scope of a DP for A-binding is defined by its entry point at LF. This indeed captures why A-bar chains do not feed A-binding.

(1b) and (2b) also contrasts but w.r.t. reconstruction effects: Only A-bar chains seem to force reconstruction, triggering a Condition C effect in (2b), but not in 2(a). This contrast is also observed for condition A, as in (3a) versus (3b) below.<sup>1</sup>

- (3) a. \*himself<sub>i</sub> seems to him<sub>i</sub> to t<sub>i</sub> be intelligent
- b. [Which picture of himself] does Mary think John likes t<sub>i</sub>

Condition A (binding of anaphor *himself*) cannot be saved by reconstructing the A-chain in (3a), but apparently can in (3b) with the A-bar

---

<sup>1</sup> Examples like (3a) were treated as condition B violations in Belletti and Rizzi's (1988) analysis of Condition A as an "anywhere" condition. However, examples such as (i) below, which is at worse marginal, raises considerable doubts as to the correctness of such analysis. Imagine a context where John is watching a pre-recorded TV quiz show in which he was the participant:

(i) ?John<sub>i</sub> expected himself<sub>i</sub> to seem to him<sub>i</sub> t<sub>i</sub> to be more intelligent

chain. Under our proposal, these contrasts indicate that reconstruction is only possible up to the entry point of DP at LF, i.e. at the tail of an A-Bar chain. The absence of reconstruction within A-chains follows directly as traces of A-chains are below the entry point and thus, inactive at LF.

Another type of example that could be interpreted as A-chain reconstruction was originally pointed out by Belletti and Rizzi's (1988) analysis of psych-verbs, such as (4).

- (4) a. [Each other<sub>j</sub>'s supporters]<sub>i</sub> frightened the candidates<sub>j</sub> t<sub>i</sub>  
 b. [Each other<sub>j</sub>'s supporters]<sub>i</sub> seem to the candidates<sub>j</sub> t<sub>i</sub> to be unscrupulous.

However Lasnik (2003) seriously questions the grammaticality of such examples and discusses numerous other similar ones that are clearly ungrammatical, such as (5).

- (5) a. \*[Each other<sub>j</sub>'s supporters] supported the candidates<sub>j</sub>  
 b. \*[Each other<sub>j</sub>'s supporters] asked the candidates<sub>j</sub> to be more supportive.

Yet, assuming such cases are grammatical, an alternative analysis of (4) is available in terms of "online" binding à la Lebeau (1988), which does not require reconstruction per se. Basically, *each other* is bound prior to A-movement (see section 2.3, examples (32)-(35) for more details).

Back to the contrasts in (1) and (2), the contrast between (1c) (from Lasnik 2003: 134) and (2c) now involves scope reconstruction. While (2c) clearly allows a narrow scope reading after reconstruction, Lasnik points out that (1c) doesn't allow the interpretation that would result from reconstructing the quantifier in the initial position of the A-chain. The same conclusion was reached in (Chomsky 1995:327) based on the following contrasts.

- (6) a. (It seems that) everyone is not there yet  
 b. I expected everyone not to be there yet  
 c. Everyone<sub>i</sub> seems t<sub>i</sub> not to be there yet

As Chomsky comments: "Negation can have wide scope over the quantifier in (a), and it seems in (b), but not in (c)...reconstruction in the A-chain does not take place, or so it occurs".

Again, the mirroring properties of A-Bar chain and A-chain w.r.t. scope reconstruction is naturally captured under our proposal. The absence of

scope reconstruction with A-chain is explained along the same line as binding reconstruction: The targeted reconstruction DP position does not exist at LF as it would be below the minimal entry point defined by case checking.

Finally, consider the contrast between (1d) and (2d) involving WCO effect. Most configurational approaches to WCO (e.g. Bijection Principle, Co-bound Variable condition, etc.) assume that some structural condition only applies to Operator-variable constructions, at the exclusion of A-chains. This can perhaps be justified if traces of A-chains are not variables (thus escaping any condition on co-bound “variables”), however, this in turn excludes a purely contextual definition of variables (to prevent traces of A-chains as locally A-bar bound variables) and requires an intrinsic definition of variables that is related to Case, which is not without problems for, e.g. PRO as a variable. Even so, it remains a stipulation that a configurational constraint on co-binding would only apply to co-bound variable traces, and not include traces of A-movement: Formally speaking, both are mere copies in minimalist terms. Under our proposal, under the absence of WCO with A-chains now follows directly from the fact there is no WCO configuration created by A-movement, i.e. traces of A-chains are not accessible at LF, thus no violation can surface.

In sum, our prediction that a DP is semantically inactive prior to its case-checking and transfer to LF is supported by the mirroring properties of A-chains and bar-chains w.r.t. binding, scope, reconstruction and WCO effects. Under our proposal, Case features must delete prior to spell out and therefore, Case checking positions define the minimal phase spell out/entry points of DPs at LF. As a by-product, this entry point also defines the transition point between argument A-chains and A-bar Chains. For instance, it fixes the c-commanding scope of a DP for binding (i.e. Binding occurs at LF) as well as its lowest reconstruction position. We will therefore adopt the following working hypothesis.

- (7) **Case Phase** (first version)  
Case feature checking (through spec-head) allows phase spell out and defines potential phasal categories.

As a consequence of (7), syntactic categories where case-checking occurs should all be potential phases: DPs (Adger 2003), ApplP (McGinnis 2004) and I now propose, AgrPs, TPs and PPs. Whether Case is the only uninterpretable feature responsible for determining potential phase categories remains an open question in this paper. Notice further that AgroP really is an extended projection of  $v$  and is therefore basically corresponding to the  $vP$

phase of Chomsky (2001). The crucial difference being that Case is the defining notion for that phase.

In the next section, an analysis of Local Binding Domain for reflexives and pronouns in English is developed based on the assumption that Case defines phasal categories and that phase categories, in turn, are the domains over which local binding is defined.

## **2. Case Phases and Binding Conditions A/B**

Generative grammar has recorded some attempts at unifying local domains for binding and movement, starting as early as Bouchard (1981) and Aoun's Generalized Binding Theory (1982). While subsequent accounts have not pursued that direction (Chomsky 1986, Reinhart and Reuland (R&R) 1993, among others), there is a legitimate appeal to this possibility from a theoretical standpoint. If indeed phases are the source of locality and strict cyclicity of movement, then finding that other local properties of grammar are exploiting the same fundamental architectural design would provide significant support for the notion and the nature of phases. In turn, it would make the system much more efficient and economical, as seemingly independent grammatical phenomena would emerge from a unique formal source.

In this second section, I develop an analysis of the nature of local binding domains for reflexives and pronouns in English based on the proposal in (7) which I refer to as Case Phase. Under this analysis, local binding domains essentially reflect the accessibility of antecedents within a phase at the C/I Interface. Such a conception of local binding domains is in line with the view that phase derivation can be justified as an economy or efficiency condition imposed by the Interfaces (bare output conditions) as phasal derivation reduces the search space and reduces backtracking and look ahead (DiSciullo 2003). Hence the use of a reflexive, instead of a pronoun, is a way for a grammar to eliminate some potential anaphoric ambiguity as early as possible, i.e. within each phase spell out. More precisely, DPs are semantically inert before being spelled out at the C/I interface and a reflexive (by opposition to a pronominal) is viewed as an element morphologically marked to be bound immediately as it enters the C/I interface, i.e. the use of a reflexive indicates that a bound anaphor has been spelled out in the same "accessible phase(s)", as its antecedent. As a result, "local binding domains" would correspond to "accessible phase domains".

### **2.1 Phase Assumptions**

To consider how such analysis would apply, let us first consider some basic assumptions about phase theory. A phase is essentially an XP category,



while the *edge* and *domain* of a phase respectively correspond to the specifier and head-complement of such an XP. Following Chomsky (2001), grammatical operations can span over at most two phases, as defined in the Impenetrability Condition in (8).

(8) Phases Impenetrability Condition (Chomsky 2001)

The domain H is not accessible to operations at ZP; only H and its edges are accessible to such operations.

[ZP Z ... [HP  $\alpha$  [ H YP]]]

According to (8), a relation within “accessible phases” can span at most two phases, provided that one of the element stands at the *edge* of the lower phase (thereby escaping it). For instance, if  $\alpha$  is at the edge of a phase HP, it is accessible to any element in the next phase up, namely ZP.

I propose that Binding Conditions A and B can be stated as (9a,b):<sup>2</sup>

- (9) a. Condition A  
 A reflexive anaphor must be bound in its accessible phases
- b. Condition B  
 A pronoun must be free in its accessible phases

## 2.2 Binding in Sentential Phases

Applied to binding relations, the local binding domain of reflexives would correspond to that “window” of accessible phases at spell out. A basic example is shown in (10) for a transitive predicate.

- (10) Legend:            (            = phase  
                              ~~John~~       = trace/copy  
                              John         = spelled out point

[[TP[John<sub>i</sub>]]([AgroP<sub>h</sub>himself<sub>i</sub>[<sub>VP</sub>John<sub>i</sub> likes himself<sub>i</sub> ]]]

TP and AgroP are the Case phases in this structure (I am assuming, following Chomsky 1995 and Lasnik 2003 that accusative case is checked in spec of AgroP, i.e. covert movement applies on the mapping to C/I). *John* becomes “semantically active” only at TP phase, i.e. after nominative Case is

---

<sup>2</sup> The question of logophoric use of reflexives within the current proposal is treated in section 2.3

checked on T. *himself* in Spec of AgroP is also active and has *John* in Spec TP as antecedent. As *himself* sits at the edge of phase AgroP, *John* is contained and accessible in the next phase, TP. In sum two “accessible phases”, as defined by PIC, would correspond to the Binding domain of reflexive and the non-binding domain of pronouns in English.

The analysis extends directly to (11) ECM constructions if we assume, following Lasnik’s (2003), that the subject of the infinitival clause raises to AgroP of the exceptional case-marking verb for case-checking.<sup>3</sup>

(11) ECM and Small clauses: parallel to transitive verbs

- a. John<sub>i</sub> believes himself<sub>i</sub> to have won  
 ([TP[John<sub>i</sub>] ([AgroP himself<sub>i</sub> [vP ~~John~~ believes [TP himself<sub>i</sub> to have won]])])
- b. Lucie<sub>i</sub> heard herself<sub>i</sub> praise Max  
 [TPLucie ([AgroP herself<sub>i</sub> [VP heard[<sub>SC</sub> ([AgrMax [VP herself<sub>i</sub> praise ~~Max~~]]]])])]

The analysis is also correct in cases where the reflexive is located in the object position of the small clause with an intervening disjoint subject (examples taken from Reinhart and Reuland 1993). In (12), the reflexive cannot be bound by the main subject, but it can be so by the subject of the small clause in (13).

(12) (R&R:688)

- Lucie<sub>i</sub> heard [Max praise her<sub>i</sub>/\*herself<sub>i</sub>]  
 [TPLucie ([AgroP Max<sub>i</sub> [VP heard[<sub>SC</sub> ([Agr<sub>o</sub> herself<sub>i</sub> [VP ~~Max~~ praise herself<sub>i</sub> ]]])])]

(13) (R&R:688)

- Lucie heard [Max<sub>i</sub> praise \*him<sub>i</sub>/himself<sub>i</sub>]

---

<sup>3</sup> Note that this prediction distinguishes our analysis from those based on the notion of co-argumenthood to predict the distribution of obligatory reflexives, such as Reinhart&Reuland (R&R, 1993) and Pollard&Sag (1992). For R&R, cases like ECM and small clauses as in (12)-(13) force their analysis into proposing that the notion of “co-argument” includes either Theta-marking or Case-marking, and crucially, only the former notion must apply to their Condition B. This seems a spurious generalization to us and it remains problematic for cases like (16) “John wanted for himself to be happy”.

[<sub>TP</sub>Lucie ([<sub>AgroP</sub> Max<sub>i</sub> [<sub>VP</sub> heard[<sub>SC</sub> ([<sub>Agro</sub> himself<sub>i</sub> [<sub>VP</sub> ~~Max~~ praise himself<sub>i</sub> ]]]]])]

Hence in (12), the small clause subject Max raises to get its Case checked and thereby triggers an AgroP phase. Even after raising to the spec of the lower AgroP (for case-checking) and escaping it, herself stands in the domain of the higher AgroP phase and must therefore be bound within it, but its intended antecedent Lucie is located higher in the TP phase. In (13) however, the reflexive is properly bound within the higher AgroP phase, i.e. is bound by the small clause subject Max.

The analysis also extends to the subtle discrepancies noted by Reuland and Reinhart between argument PPs in (14) and adjunct PPs in (15), where the complementary distribution between pronouns and reflexives seems to collapse.

(14) Argument PPs (R&R:661)

- a. *Max* speaks with *himself*/*\*him*
- b. *Lucy*'s joke about *herself*/*\*her*

(15) Predicate and adjunct PPs (R&R:664)

- a. *Max* saw a gun near *himself*/*him*
- b. *Lucy* counted five tourists in the room apart *herself*/*her*

These examples first raise the question of the status of PP as a potential phase category. As P marks Case, PPs could arguably define a phase domain according to our proposal in (7). However, a general assumption about PP is that it does not involve structural Case-checking under spec-head agreement but rather, inherent Case marking, i.e. case related to theta role assignment. One might therefore question whether inherent Case, insofar as it is related to theta-role assignment, is an uninterpretable feature. If there is an inherent case feature, it is also very plausible that it is canceled in situ upon merging, i.e. upon theta role assignment.

For our analysis' standpoint, if the "in situ" cancellation of Case in PPs triggered a strong phase, it would imply that a DP within a PP could never be a reflexive, clearly an undesirable conclusion. Let us explore this plausible assumption further and assume that the configuration in (23) is one where only a *weak* phase is defined, by virtue of the lack of movement for Case checking. More formally, let us revise (7) as (7').<sup>4</sup>

---

<sup>4</sup> Notice that extending (7') to another uninterpretable feature such as [Wh] would make CP a strong phase as well in context of Wh-movement. Yet another way of making CP a

(7') **Case Phase** (final version)

Case feature checking through movement defines potential strong phasal categories.

Under these revised assumptions, let us first consider the analysis of examples involving argument PPs. Argument PPs have their theta-role assigned by the verb and must arguably be merged and spelled out along with the verb for interpretation. That assumption yields the correct results: Argument PPs will always require a reflexive if bound by a co-argument, either a subject in (16) or an object in (17) (= R&R:636).

(16) Max<sub>i</sub> speaks with himself<sub>i</sub>

([TP[Max<sub>i</sub>] [<sub>v</sub>P Max<sub>i</sub> speaks [<sub>pp</sub>with himself<sub>i</sub>] ]])

(17) Lucie explained Max<sub>i</sub> to himself<sub>i</sub>/\*him<sub>i</sub>

([TP[Lucie] ([AgrPMax<sub>i</sub> [AgrP [<sub>v</sub>P~~Lucie~~ explained [Max<sub>i</sub>] [<sub>pp</sub> to himself<sub>i</sub>/\*him<sub>i</sub>] ]])])])

In contrast, adjunct PPs are not dependent on the verb for theta role assignment of their DP complement, which opens the possibility that they may or not spell out in the same phase as the verb. In the spirit of Lebeaux (1988) and Uriagareka (1999; within a multiple spell-out framework), PP adjuncts are merged independently of the main predicate/argument structure, through generalized transformations. This predicts that two structures are possible for adjunct PPs, depending on whether a PP is merged at the edge or in the domain of an AgroP phase.<sup>5</sup> If PP merges at AgroP's edge, it escapes the AgroP phase for the purpose of PIC. In such case, a reflexive is required as shown in (18). If however PP spells out in AgroP's domain (e.g. in the VP), the reflexive is out and the pronoun is in, as in (19).

(18) ([TP[John<sub>i</sub>] [AgrP<sub>a</sub> gun [AgrP [<sub>v</sub>P~~John<sub>i</sub>~~ saw a ~~gun~~] [<sub>pp</sub> near himself<sub>i</sub>] ]])])

(19) ([TP[John<sub>i</sub>] ([AgrP<sub>a</sub> gun [AgrP [<sub>v</sub>P~~John<sub>i</sub>~~ saw a ~~gun~~] [<sub>pp</sub> near him<sub>i</sub>] ]])])])

---

strong phase is actually Case, assuming that CP is case-marked. See Canac-Marquis (in progress) for an analysis along those lines.

<sup>5</sup> I keep assuming here that AgroP is actually an extended projection of *v* and therefore, the PP still modifies the *v*P as required by the interpretation.

The analysis therefore implies that there is no collapsing of the complementary distribution of reflexives and pronouns in those examples but rather, two distinct derivations are possible by virtue of the adjunct status of the PP, each derivation requiring a different type of anaphor.

This analysis of PPs further makes the prediction that if an antecedent is in the same phase despite the adjunct PP merging to AgroP, a reflexive is required. And indeed, such is the case when the antecedent is an object argument as in (20) (R&R:668).

- (20) John rolls the carpet<sub>i</sub> over \*it<sub>i</sub>/itself<sub>i</sub> (cf. Max rolled the carpet over him/himself)
- a. ([<sub>TP</sub>[John] ([<sub>AgroP</sub>the carpet<sub>i</sub> [<sub>AgroP</sub> [<sub>vP</sub>John rolls ~~the carpet~~ [<sub>PP</sub>over itself<sub>i</sub>] ]]]])
- b. ([<sub>TP</sub>[John] [<sub>AgroP</sub>the carpet<sub>i</sub> [<sub>AgroP</sub> [<sub>vP</sub>John rolls ~~the carpet~~] [<sub>PP</sub>over itself<sub>i</sub>] ]]])

(20a) is the derivation with the PP in the domain of the AgroP phase, and it is bound by the direct object, requiring a reflexive. In (20b), the PP is merged at the edge of the AgroP phase that it thereby escapes, but the direct object also remains in the same AgroP phase and a reflexive is still required.

The latter analysis of co-bound arguments seems to clash, however, with PPs in double object constructions. First note that the analysis of the dative shift example in (21) where the reflexive in the indirect PP is bound by the direct object, can be treated similarly to (20).

- (21) I presented Max<sub>i</sub> to himself<sub>i</sub>/\*him<sub>i</sub> (Larson 1988 ex (5))
- ([<sub>TP</sub>[I] ([<sub>AgroP</sub>Max<sub>i</sub> [<sub>AgroP</sub> [<sub>vP</sub>I explained [<sub>Max<sub>i</sub>] [<sub>PP</sub>to himself<sub>i</sub>/\*him<sub>i</sub>] ]]])</sub>

However, in the case where the reflexive in the PP is bound by the subject, we would expect the reflexive to be excluded and the pronoun mandatory, as the reflexive is embedded in the AgroP domain defined by the direct object. Yet, the distribution is exactly the opposite, as shown in (22).

- (22) Lucie<sub>i</sub> sent shoes to herself<sub>i</sub> /\*her<sub>i</sub>
- ([<sub>TP</sub>[Lucie<sub>i</sub>] ([<sub>AgroP</sub> shoes [<sub>AgroP</sub> [<sub>vP</sub> Lucie sent [shoes<sub>i</sub>] [<sub>PP</sub>to herself<sub>i</sub>/\*her<sub>i</sub>]...]

From the perspective of our analysis, the behavior of the reflexive in (22) directly contrasts with ECM (11) and small clause (12-13) in which the main subject because of the intervening AgroP phase cannot bind a reflexive. Clearly, some crucial factor must distinguish these constructions from the double object one. An indeed, a closer look at the double object analysis of Larson (1988) offers an interesting possibility when re-considered under minimalist assumptions. This is illustrated in (23).

(23) VP shell analysis (Larson 1988, Chomsky 1995, among others)

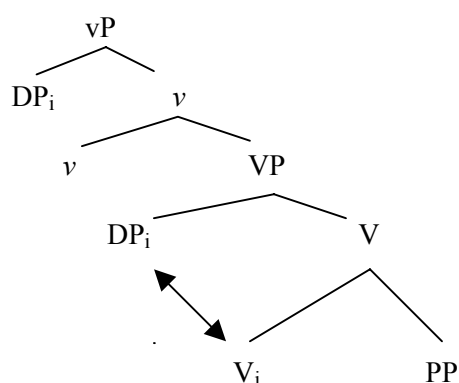

According to the original VP shell analysis of Larson, the direct object is generated in the specifier of V. Though Larson proposed that V raises further in *v* for Case-checking, another plausible analysis is that the spec-head agreement configuration is already achieved at merger and DP need not raise for Case-checking (notice that V itself would still need to raise independently, arguably for predication of the external argument). In minimalist terms, this is arguably the most economical option. The result would in fact render this type of case checking configuration similar to inherent Case of PPs insofar as no movement is required to check Case, i.e. Case would be checked upon merger and theta role assignment. In fact, our proposal in (7') already specifies that such must be the case. Hence (22) can be reanalyzed as (24).

(24) Lucie<sub>i</sub> sent shoes to herself<sub>i</sub> /\*her<sub>i</sub>  
 ([<sub>TP</sub>[Lucie<sub>i</sub>] [ [<sub>VP</sub> Lucie<sub>i</sub> sent [shoes]]<sub>PPto</sub> herself<sub>i</sub>/\*her<sub>i</sub>] ])

Notice that there is no AgroP phase anymore, as Case is assigned/canceled at merger *in situ* and by assumption, only a weak phase is created. The indirect PP object therefore lies in the main TP phase and if bound by the subject, must be a reflexive.

One more case involving a preposition falls naturally under our analysis, namely the reflexive subjects of *for*-clause:

- (25) John<sub>i</sub> wanted for himself<sub>i</sub> to be happy  
 ([<sub>TP</sub>[John<sub>i</sub>] [<sub>VP</sub>John<sub>i</sub> wanted] [<sub>CP</sub> for [<sub>TP</sub> himself<sub>i</sub>/\*him<sub>i</sub> to be happy]  
 ]])

According to standard analyses, *for* is a prepositional complementizer assigning structural case to the subject of the infinitive (Kayne 1981, Chomsky 1981). Since *for* is prepositional and does not trigger spec-head agreement, CP only creates a weak phase under (7') and the main TP is therefore the strong phase containing himself and its antecedent, John. The choice of the reflexive over the pronoun follows directly. Note that this type of example is another case distinguishing our analysis from those treating reflexivity as a property of co-arguments, as Reinhart and Reuland (1993).<sup>6</sup> Clearly, the subject of the infinitival is not a co-argument of the main verb, and the case assigner *for* is not the main predicate either. The fact that a reflexive is mandatory in this context strongly suggests that co-argumenthood is not the definitive notion to capture its distribution.

### 2.3 Binding in DP Phases

Let us now consider how the main paradigm of binding in DPs would develop under our analysis. Following Adger (2002), but also Svenonius (2005) and Hiraiwa (2005), DPs are strong phases. In our terms, this assumption follows as DPs are Case-marked and until their case is checked, they cannot be spelled out. Assuming so, DPs therefore create a phasal binding *domain* for our conditions A and B and any reflexive embedded in a DP domain can only be bound by an antecedent within DP. That is generally the case with picture noun phrases with prenominal subjects, as in (24).

- (26) a. Mary<sub>i</sub> likes ( [<sub>DP</sub> John's picture of \*herself<sub>i</sub>/her<sub>i</sub>]  
 b. Mary likes ( [<sub>DP</sub> John<sub>i</sub>'s picture of himself<sub>i</sub>/\*him<sub>i</sub>]

These cases do not pose any peculiar challenge to our analysis. The *of*-PP is a weak phase and the prenominal DP *John* is also a weak phase (and

---

<sup>6</sup> Reuland and Reinhart treat such cases as exceptional, where *himself* would be used as a logophoric reflexive in this context and this, despite the fact that the pronoun is clearly excluded under a subject-bound reading. As R&R mention (1993:712) "We doubt, however, that any theory should be modified to account for such cases". We agree in that, no theory should treat such cases as marginal but rather, they should fall from general assumptions. See our analysis of (16).

in any case, does not include the anaphor), which leaves DP as the first accessible strong phase and binding domain.

Cases where no subject is present, as in (26), could be treated along the lines of Chomsky (1986) proposal that a (controlled) PRO is accessible in those constructions.

(27) Lucie<sub>i</sub> saw a picture of herself<sub>i</sub>/her<sub>i</sub>

([TP[Lucie<sub>i</sub>] ([AgrP ([DP a PRO<sub>i/j</sub> picture [of her<sub>i</sub>/herself<sub>i</sub>]] [vP saw a picture of herself<sub>i</sub> ]

The analysis essentially follows the lines of (26), with PRO as the accessible subject in the DP phase. PRO however can either be controlled by the subject, allowing the reflexive reading, or be arbitrarily controlled, allowing the pronoun to appear as bound by the subject.

Notice that a construction such as (27) is treated quite differently in approaches based on co-argumenthood. For R&R for instance, there is no syntactic PRO in (27), so there is no syntactic co-argument for the reflexive, which thereby escapes their reflexive binding condition. This implies that for R&R, the anaphor in (27) is used logophorically. A somewhat similar analysis in spirit is also found in Pollard and Sag (1992, 1994) and Manning and Sag (1999) where the anaphor in (27) is an “exempt-anaphor” (i.e. exempted from binding conditions) since it does not have a co-argument in its argument structure and may thereby satisfy binding vacuously and be used logophorically. Both of these approaches rely on the assumption that there is a complementary distribution between bound and logophoric uses of reflexives, as defined by syntactic and /or syntactic co-argumenthood. This assumption, however, is not without problems. Example (16) above with the *for* complementizer, as well as case of ECM (11) and small clauses (12)-(13), require treating syntactic and semantic co-arguments as separate notions for Binding purposes. In addition, there are clear cases where co-arguments of a bare predicate escape binding conditions, as pointed out in Zibri-Hertz (1989:719) who cites examples such as (28).

(28) John<sub>i</sub> thinks that Paul<sub>j</sub> hates himSELF<sub>i/j</sub> more than anyone in the world

This type of example indicates that co-argumenthood cannot be considered a *sin-qua-non* condition for reflexive binding. As nicely argued in Gast (2004) a *self*-form seems to be used logoriphically only if it refers to the ‘assigned epistemic validator’ of a discourse segment, rather than if it is not a co-argument of some reflexive-marked predicate. In other words, it seems



that discourse and pragmatic factors validate logophoric uses of reflexives mere “exemption” is not a sufficient condition.

Back to examples (26) and (27), Runner and Kaiser (2005:55) bring up a number of convincing arguments related to ellipsis, collective reading and “only” construction suggesting that the possessor NP in (26) is not an actual argument of the *picture* noun. For instance, Runner and Kaiser point out the contrasts between (29) and (30) w.r.t. the bound variable and strict readings:

(29) John<sub>i</sub> hates himself<sub>i</sub> and so does Fred

(30) John<sub>i</sub> has a picture of himself<sub>i</sub>, and so does Fred.

Whereas (29) only allows for a bound variable reading, (30) allows for both a bound and strict reading. This follows, according to Runner and Kaiser, if in (30) *John* and *himself* are not co-arguments and *himself* is exempted from Binding condition A, allowing the strict/coreferential reading. The crucial examples are then (31) (Runner Sussman and Tnenhaus 2002) and (32) (Runner 2003):

(31) *Jimmy bought JFK's picture of himself for \$500 not realizing he could've bought the museum's for just \$100 in its going out business sale.*

(32) (n.b. quote captured during a live psycholinguistic experiment)

*Pick up Joe. Have Joe touch Ken's picture of himself. Now, have Joe touch Harry's picture of himself.*

These examples involve an overt possessor in the NP and similarly to (30), both a bound variable and co-referential reading are available. Runner and Kaiser logically conclude, based on the parallel with (30) and the contrast with (29), that the possessor is not a co-argument of the picture phrase. If that is correct however, an analysis based on co-argumenthood fails to capture why a condition B is still applying in the same structural environment as (31) and (32), as shown in (33).

(33) Mary likes [<sub>DP</sub> John<sub>i</sub>'s picture of \*him<sub>i</sub>/himself<sub>i</sub>]

If the possessor *John* is not a co-argument of *him* in (33), why are conditions A/B mandatorily applying? Again, the notion of co-argumenthood seems to fall short of capturing the true generalization for the identification of the domains for binding conditions. In contrast, our proposal does not face this type of issue as the argument or co-argument

status of the pronominal possessor is irrelevant: Only its presence, or absence, within the accessible phase of the reflexive makes it a mandatory binder or not in (33). Indeed, the pronoun must be free in its accessible phase DP, which includes the overt pronominal possessors in both examples.

As for the long distance readings in (31) and (32), we must either maintain that these are true cases of logophoric use of *himself* or provide an alternative analyses for it. There are a number of options to explore at this point and I will discuss two.

One option, which relates to other contexts of long distance binding, is to treat cases like (33) as instances of “online binding”. Cases of online binding refer to examples such as (34) for A-movement and (35) for A-bar movement.

- (34) Each others’ supporters frightened the candidate  
 [TP ([AgrP [DPthe candidates]<sub>i</sub>] [AgrP[DPeach other’s]<sub>j</sub> supporters]<sub>j</sub>] [<sub>vP</sub> frightened t<sub>j</sub> t<sub>i</sub> ...]
- (35) John<sub>j</sub> wonders [which pictures of himself]<sub>j</sub><sub>i</sub> Mary likes t<sub>i</sub>
- (36) \*John<sub>i</sub> wonders if Mary likes a picture of himself<sub>i</sub>

Cases like (34) involve psych-predicates which following the original analysis of Beletti and Rizzi (1988), are double object predicates with theme and experiencer internal theta roles. In the spirit of Beletti and Rizzi, but also Lebeau (1988) this type of examples where the reciprocal seems to precede its antecedent can be treated as an instance of binding before raising of the theme argument in subject position, as illustrated in the structure in (34). Under our analysis, this is possible if *each other’s* can be spelled out at the same time as its antecedent: *the candidates*. Notice that the accusative case feature of *the candidates* is case-checked in spec of AgrP, making the latter a phase domain. At that point of the derivation, *supporters* cannot obviously check its nominative Case, however, *each other’s* presumably can in spec of DP. Indeed, *each other’s* bears a genitive case on its sleeve as a morphological mark, and similarly to PPs, can arguably have its case checked *in situ* (in spec of DP). Notice that nothing prevents spelling a subpart of a constituent such as DP. In fact, phase spell out is all about spelling out sub parts of larger constituents.

In sum, we are considering the option that the reciprocal in (34) can spell out in the same phase as its antecedent by virtue of (i) carrying its own genitive/possessive Case, thus creating its own weak phase, and (ii) being an adjunct and thus not requiring to be spelled out in the same phase as a selecting predicate. Now considering cases like (35), which were originally

pointed out in Barss (1986), we can surmise that the anticipated spell out involving A-movement in (34) finds a mirror application for A-bar movement in (35). In (35), the reflexive *himself* behaves not as if it needed to be spelled out by anticipation, but rather, as if it were allowed to be delayed until it reached a higher point in the derivation, through A-bar-movement, until a targeted antecedent would be available. Notice the contrast with (36), which indicates that *himself* cannot be treated as a logophoric or exempt-anaphor in these types of examples. The analysis for (35) is shown in (37).

(37) ([<sub>TP</sub>John<sub>j</sub> wonders ([<sub>CP</sub> [~~which pictures of himself~~]<sub>i</sub>] Mary ([<sub>AgroP</sub> which pictures [<sub>PP</sub> of himself]<sub>i</sub>]) likes [~~which pictures of himself~~]<sub>i</sub>])

The Wh constituent first moves to spec of AgroP in the embedded clause to check accusative case on *which picture*. Notice that even though *which picture* spells out to C/I interface, the phonetic features of *which picture* must carry on as required by pied pipping for Wh-movement.<sup>7</sup> At that point also, the PP *of himself* does not spell out, by virtue of its adjunct status and weak phase. Further movement of the Wh constituent for Wh-feature checking allows the PP to pied pipe its way to spec of CP, at which point it can spell out. Being in the spec of CP, it escapes CP phase, which allows the PP *of himself* to be in the same TP phase as its targeted antecedent, *John*.<sup>8</sup>

We can now go back to the analysis of examples (31) and (32) under these assumptions. An alternative suggested by the latest discussion would exploit once again the weak phase and adjunct status of the PP *of himself*. Very simply, the same way the PP can delay its spell out to account for long distance cases such as (35), let us consider without further assumption that the same option is available in (31) and (32). This yields appropriate results. By delaying its spell out, the PP escapes the DP phase and can reach an antecedent within the main clause, as is the case in (31) and (32). This analysis hence correctly captures the fact that *himself* can choose either the local antecedent in the DP of the more distant one in the main clause. It also captures the asymmetry between an anaphor and a pronoun in the same context. Hence, even if the pronoun escapes the DP phases, the pronominal possessor will still bind it within the same TP phase.

<sup>7</sup> Perhaps this can be viewed similarly to cases of “remnant” movement, in the spirit of Kayne (1995) and related work.

<sup>8</sup> Examples where the main predicate selects double objects DP CP as (i) below would required an analysis of case assignment of the DP similar to double object of type DP PP, as in (22) in the text.

(i) John<sub>i</sub> asked [Mary] [which picture of himself]<sub>i</sub> she preferred.

Further exploration of this first option for (31) and (32) would have to determine whether the same structural contexts with de-verbal predicates such as *destruction* in (38) is expected to yield different results, as the PP would not have an adjunct status and would have to spell out with its predicate, within DP.

(38) Ebenezer<sub>j</sub> saw [John's<sub>i</sub> destruction of himself<sub>?j/i</sub>]

Preliminary native judgments seem inconclusive and further research into this question is warranted. Another prediction of this first analysis of (31) and (32) is that an even longer distance than the “next phase up” should not validate a long distance reading, as in (39) and (40).

(39) John<sub>i</sub> said that Bill<sub>j</sub> saw [Jacob's<sub>k</sub> picture of himself<sub>k/j/?i</sub>]

(40) John<sub>i</sub> said that there was [Jacob's<sub>j</sub> picture of himself<sub>j/?i</sub>] in the post office.

Initial native speaker judgments of these examples seem to indicate that distance is not the distinguishing factor. If that is so, a second option for the analysis of (31) and (32) needs to be explored.

The second option, along the spirit of the “exempt-anaphor” of Pollard and Sag, is to explore the idea that a reflexive can escape a binding condition vacuously if one of the pre-conditions is not fulfilled. Under our approach however, such a pre-condition could not be, as in the Pollard and Sag approach, a factor such as “...the presence of a co-argument in the argument structure...”, since co-argumenthood is not a component of our binding conditions. Rather, “accessibility of an antecedent in a phase” would be. In other words, if binding condition A were to apply *only* if a potential and accessible antecedent resided within the same phase, this would allow condition A to be exempted in case there were no such antecedent. This condition seems plausible to the extent that the absence of any accessible antecedent in a phase containing a reflexive could only be interpreted as an attempt at logophoric reference, not locally bound anaphora. This is also in line with our general assumption that the use of pronouns and anaphors is motivated by economy conditions: There is no potential ambiguity to eliminate if there is no potential antecedent in the phase of the reflexive. Let us therefore reformulate our Condition A in (9) as follows:

(9') Condition A  
A reflexive must be bound in its phase only if there is an antecedent in the phase.

The consequence of (9') for the analysis of (31) and (32) is straightforward. Since the pre-nominal possessor resides outside the *domain* of the DP phase and can be spelled out independently of the domain, *himself* can be spelled out without a potential antecedent in its DP *domain* phase. If that option is chosen, the reflexive escapes (9') and need not be bound in its phase, i.e. it is exempted and can be used logophorically if the discourse conditions are adequate. Condition B as originally stated in (9) need not be reformulated as it requires a pronoun to be free in its “accessible phases”, i.e. in all phases that it could be spelled out in. In (32), the pre-nominal possessor is at the edge of the DP phase, thus in an “accessible phase” for the pronoun in the DP domain: The pronoun must therefore be free in DP.

### Conclusion

This paper extends the theory of derivation by phase (Chomsky 2001), originally proposed for locality and cyclicity effects on movement, to capture local binding domains of pronoun and reflexives in English. First arguing that phases are partitioned on the basis of spec-head checking of uninterpretable features such as Case, I then proposed that the local binding domains for reflexives and pronouns in English are defined in terms of accessible phase domains. The choice of a reflexive (Condition A) over a pronoun (Condition B) is dictated by whether or not the antecedent is located in the same accessible phases at phase spell to the C/I interface. The analysis contrasts with standard analyses whereby co-argumenthood is a core factor in determining the contexts where binding conditions apply.

### References

- Adger, David. 2003 Stress and Phrasal Syntax. *GLOW* abstract.
- Aoun, J. 1982. *The Formal nature of Anaphoric Relations*. MIT Ph.D. Dissertation.
- Barss, Andrew. 1986. *Chains and Anaphoric Dependence: On Reconstruction and its Implications*. Doctoral Dissertation. MIT, Cambridge, Mass.
- Belletti, A. & G. Rizzi. 1988. Psych verbs and Theta Theory. *Linguistic Inquiry* 19: 1-34.
- Canac-Marquis, R. 2004. Bound Pronoun Variables and Incremental Interpretation, in A. Branco, T. McEnery and R. Mitkov (eds) *Proceedings of DAARC 2004*. Lisboa, Portugal: Ediçoes Colibri : 39-54
- Canac-Marquis, R. 2005. “Phases and Local Binding Domains, paper presented CLA annual meeting, University of Western Ontario.

- Chomsky, N. 2000. Minimalism: The Framework. In *Step by step: Essays in Syntax in Honor of Howard Lasnik*, ed. by J. Martin, D. Michael and U. Uriagereka. 89-155. Cambridge, Mass: MIT Press.
- Chomsky, N. 2001. Derivation by Phase. In *Ken Hale: A Life in Language*.ed. by Michael Kenstowicz, 1-52. Cambridge, Mass: MIT Press.
- Di Sciullo, A.M. 2003. Morphological Phases. In Hang-Jin Yoon (ed.) *Generative Grammar in a Broader Perspective*. Proceedings of the 4th GLOW in Asia 2003
- Gast, Volker. 2004. The Interpretation of Logoriphic self-Forms. In A. Branco, T.McEnery and R. Mitkov (eds) *Proceedings of DAARC 2004*. Lisboa, Portugal: Ediçoes Colibri.
- Hiraiwa, K. 2005. *Dimensions of Symmetry in Syntax* MIT Ph.D. Dissertation.
- Kayne, R.1981. On Certain Differences Between French and English, *LI* 12.
- Kayne, R. 1995. *The Antisymmetry of Syntax*. Linguistic inquiry Monopgrap 25. Cambridge, Massachussets: The MIT Press.
- Kaiser, Elsi and Jeffrey Runner, 2005. Binding in Picture Noun Phrases. In *Lisbon Binding Workshop: Invariants in Anaphoric Relations*. Antonio Branco, F. Costa and M Sailer (eds.). Technical Reports: Departamento de informatica, University of Lisbon. <http://www.di.fc.ul.pt/tech-reports>.
- Lasnik, H. 2003. *Minimalist Investigations in LinguisticTheory*. Routledge : London
- Lebeau, D. 1988. Ph. D. Dissertation, University of Massachusetts, Amherst. Published by GLSA.
- Manning, C. and Ivan Sag 1999. Dissociations between Argument Structure and *grammatical relations*. In *G Webelhuth, J.-P. Koenig and A. Kathol (eds.), Lexical and Constructional Aspects of Linguistic Explanation*. Standford: CLSI Publications.
- McGinnis, Martha 2003 Lethal Ambiguity. *LI*, 35, 1:47-97
- Pollard, C. and Ivan A. Sag 1992. Anaphors in English and the Scope of Binding theory. *Linguistic inquiry* 23:261-303.
- Reinhart, T. 1983. *Anaphora and Semantic Interpretation*, University of Chicago Press, Chicago, Illinois.
- Reinhart, T. and E. Reuland. 1993. Reflexivity. *LI* 24,4: 657-721
- .
- Svenonius, P. 2004. On the Edge, in D. Adger, C. de Cat and G. Tsoulas (eds). *Peripheries: Syntactic Edges and their Effects*. Kluwer Academic.
- Uriagereka, J. 1999. Multiple Spell Out, in S.D. Epstein & M Hornstein (eds) *Working Minimalism*. Cambridge, Mass: The MIT Press. pp. 251-283.

# On binding domains

Martin Everaert 

Utrecht University

Proceedings of the 12th International Conference on  
Head-Driven Phrase Structure Grammar

Department of Informatics, University of Lisbon

Stefan Müller (Editor)

2005

Stanford, CA: CSLI Publications

pages 503–518

Everaert, Martin. 2005. On binding domains. In Stefan Müller (ed.), *Proceedings of the 12th International Conference on Head-Driven Phrase Structure Grammar, Department of Informatics, University of Lisbon*, 503–518. Stanford, CA: CSLI Publications. DOI: 10.21248/hpsg.2005.29. 

## Abstract

\*In this paper I want to explore reasons for replacing Binding Theory based on the anaphor-pronoun dichotomy by a Binding Theory allowing more domains restricting/defining anaphoric dependencies. This will, thus, have consequences for the partitioning of anaphoric elements, presupposing more types of ‘anaphors’/‘pronouns’ than standard Binding Theory offers us.

### 1. Introduction

Mainstream generative accounts (Chomsky 1981; Pollard & Sag 1994; Manning & Sag 1999; Bresnan 2002, and Reinhart & Reuland 1993) sketch a very clear, uniform picture of anaphoric dependencies. Binding in the syntactic sense of the word is primarily limited to the predicational domain, formulated as in binding conditions A (cf. 1) and B (cf. 2):<sup>1</sup>

- (1)
  - a. An anaphor is bound in its Governing Category.
  - b. A locally a-commanded short-distance reflexive must be locally a-bound.
  - c. A nuclear (reflexive) pronoun must be bound in the minimal nucleus that contains it.
  
- (2)
  - a. A pronominal is free in its Governing Category.
  - b. A pronoun must be locally a-free.
  - c. A nonnuclear pronoun must be free in the minimal nucleus that contains it

‘Reflexives’ are subject to condition (1), i.e. they are referentially dependent upon a hierarchically superior NP (cf. 3a), and the antecedent must be found within a certain domain (cf. 3b).<sup>2</sup>

---

\* I would like to thank the organizers of the workshop, António Branco and Manfred Sailer, and the editor of this volume, Stefan Müller, for giving me the opportunity to present my work, and their patience. Alexis Dimitriadis, Shakuntala Mahanta, Eric Reuland, Anca Sevcenco, Giorgos Spathas have contributed, in different ways, to this paper, for most without knowing it.

<sup>1</sup> Limiting myself to ‘condition A/B’, following Reinhart (1983).

<sup>2</sup> Anaphoric dependencies are indicated by italics.



- (3) a. \**John's plans failed himself*  
 b. \**John thinks that Mary hates himself*

'Pronominals' obey condition (2), the reverse from (1): whatever the reference of the pronoun may be, it is not able to take a co-argument for an antecedent.

These standard generative binding conditions (cf. Everaert 2003 for a comparison of Binding Theories in several generative frameworks) describe recurrent patterns in the various languages of the world. Examples from Finnish (4a), Sakha (4b, personal communication Nadya Vinokurova), and Spanish (4c) illustrate that, in many languages, reflexives and pronominals are, indeed, in complimentary distribution:

- (4) a. *Pekka näki itsensä/\*hänet*  
 'Pekka saw himself/him'  
 b. *Misha bejetin/\*kinini tapyyr*  
 Misha himself/him loves  
 'Misha loves himself/him'  
 c. *Juan se/\*lo admira*  
 'Juan admires himself/him'

The examples in (5), from Italian, Dutch, Russian, and Icelandic, respectively, show that, in addition, reflexives must be locally bound, while pronominals allow non-local binding:

- (5) a. *Gianni pensava che Maria \*si/lo ammirasse*  
 'Gianni thought that Maria admired him'  
 b. *Jan vroeg mij voor \*zich/hem te werken*  
 Jan asked me for himself/him to work  
 'John asked me to work for him'  
 c. *Vanja думаet čto Maša uvažает \*sebjajego*  
 'Vanja thinks that Maša admires him'  
 d. *Jón veit að María elskar \*sig/hann*  
 John knows that Maria loves-IND himself/ him  
 'John knows that Maria loves him'

In all generative accounts (HPSG, LFG, P&P, etc.) there seems to be general agreement on the following properties being encoded in Binding Theory:

- (6) i. Reflexivization is local.

- ii. A distinction must be drawn between two types of anaphoric element: anaphors (= reflexives and reciprocals) and pronouns.
- iii. Any anaphoric dependency that is non-local is either exceptional, marked or does not fall under Binding Theory proper. In other words, anaphor resolution (as it is used in the literature on discourse) is outside the scope of Binding Theory.

In this paper I will focus on (6ii). However, it will become clear that this is only possible if we also address (6i). In other words, I will discuss:

- (7) i. the notion ‘domain’/‘locality’.
- ii. the partitioning of elements that are sensitive to binding restrictions.

It is important to observe that I will be guided by the principle in (8), which is inspired by a view, formulated in (9), on what syntax might be:

- (8) Binding Theory deals with those nominal expressions that encode their referential properties in the morpho-syntactic vocabulary (feature system) of a specific language.
- (9) “One of the prerequisites for attaining the goals of the Minimalist Program (MP) developed in Chomsky 1995, 2000, to appear, is to draw the boundaries of syntax in a principled way. The MP proposes that the computational system of human language ( $C_{HL}$ ) reflects the combinatorial properties of a purely morpho-syntactic vocabulary.” Reuland (2001: 440)

My starting point is that any grammatical feature that is morpho-syntactically encoded might be, in principle, be relevant for binding. Taking (8) as a fundamental principle will significantly widen the empirical scope of the Binding Theory. It defines it as an interface system, as discussed in Reuland (2001). Although what I propose is compatible with Reuland’s position, the focus is slightly different. Reuland (2001) is focused on the binding principles A and B, both part of syntax, replacing syntactic ‘identity derived by co-indexation’ from ‘identity derived by movement’. I am arguing that there might be reason to extend Binding Theory to discourse.

## **2. Partitioning of anaphoric elements**

Nominals are generally partitioned as follows (Pollard & Sag 1994):

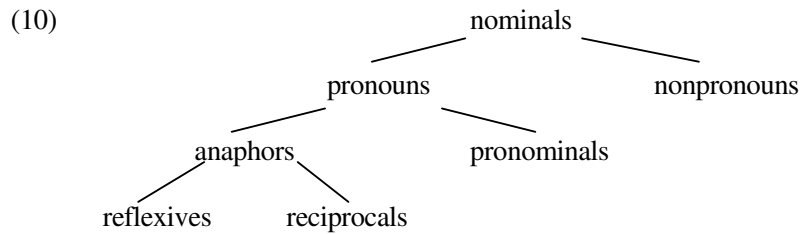

Since we generally accept that reflexives and reciprocals behave the same with respect to binding conditions, (10) is reduced to (10'), with the three binding conditions indicated:

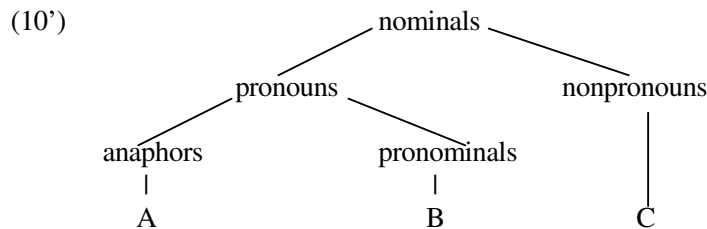

Let us, for the moment, focus on binding condition A (cf. 1). It restricts elements classified as 'anaphors' to be bound locally. And local is defined in several ways:<sup>3</sup>

(11) 'subcat-list', 'arg-structure', 'complete functional complex', 'predicate', etc.

Condition A, however, is not without exceptions. Quite early on it was noted that, cross-linguistically, there were many anaphors with antecedents essentially beyond the regular domain (Thráinsson 1976, Reis 1976, Inoue 1976, Yang 1983, Harbert 1983, and many others since). The examples in (12), Norwegian, Dutch, Japanese and Icelandic, respectively, illustrate this:

- (12) a. *Jon bad oss hjelpe seg*  
 Jon asked us help himself  
 'John asked us to help him'
- b. *Jan laat mij voor zich werken*  
 Jan made me for himself work  
 'John made me work for him'

<sup>3</sup> A very different take on locality is the assumption that anaphora domains and NP-movement domains coincide (Reuland 2001, Hornstein 2001).

- c. *Bill-wa* John-ga *zibun-o* seme-ta to omot-ta  
Bill John himself blamed that thought  
'Bill thought that John blamed him'
- d. *Jón* segir að *Péturi* raki *sig* á hverjum degi  
Johnn says that Peter shave himself at every day  
'John says that Peter shaves him every day'

Following the terminology of Koster & Reuland (1991) we will classify the exceptions to binding condition A in (12a,b) as medium distance binding, and those in (12c,d) as long distance binding. Medium distance is reflexivization that is non-local, but the non-locality is restricted to a reanalysis/small clause domain. The phenomenon of long distance binding, a binding relation between an anaphor and a non co-argument antecedent, is tackled in different ways:

(13) *Long distance binding* is:

- a. reduced to locality, and thus condition A, through LF-movement: Pica (1984), Cole & Sung (1994), a.o.
- b. relegated to non-syntactic binding: Reinhart & Reuland (1991, 1993), Pollard & Sag (1994), Reuland (2001), a.o.
- c. accounted for by introduction of a fourth binding condition, principle Z: cf. (14) for a formulation of the principle

(14) *Principle Z* (Xue et al. 1994, and others; formulation from Branco 2005)  
An o-commanded long-distance reflexive must be o-bound.

It is this fourth binding condition, principle Z, that allows Branco & Marrafa (1997) and Branco (2005) to explore the possibility of deriving the binding conditions from a more general principle of quantification structure. Branco (2005) argues that the empirical generalizations captured in the definition of the four binding principles, conditions A,B,C and principle Z, are “just the effect of the specific quantificational force of the anaphors lexically encoded in their semantic values” (Branco 2005: 166). So, the question whether the four-way partitioning of binding conditions is motivated, and linked to well-motivated partitioning of lexical elements, becomes an important one.

In the way Principles A and Z are formulated a distinction is made between short-distance and long-distance binding. The question, of course, is whether such a distinction is motivated. And if so, could it be that this distinction is derived from other principles of grammar. Many have argued that it could be derived from the morphology of anaphoric elements. Pica (1985) argued that long distance anaphors are heads, short distance anaphors are ‘complex’.

Everaert (1986) argued that the fact that certain anaphors require strict local binding follows from their morpho-syntactic make-up.<sup>4</sup> Alternatively, we could derive the distinction between short distance anaphors and long distance anaphors from a well-defined feature specification. Everaert (1991) argues that short distance anaphors could be seen as +A,-P specified, to be distinguished from +A,+P long distance anaphors. Defining the notions ‘governing category’/ ‘minimal governing category’ relative to the A(naphor)- and P(ronominal)-features, respectively, Everaert derives that <+A,+P> reflexives, bound in some governing category and in their minimal governing category, are necessarily locally bound, while <+A,-P> reflexives, bound in some governing category and not bound in their minimal governing category, are not.

I will assume that, indeed, something like principle Z exists, but that it is, perhaps, the only binding principle in the traditional sense of the word that exists. Following Everaert (1986) I would like to suggest that binding condition A is, a priori, non-local, but limited to the sentence-internal domain.

### 3. Domains

What would be a priori domains relevant for anaphoric dependencies? The first distinction seems to be the distinction between the domain in which syntax is relevant, sentence grammar (cf. 15a,b), and the domain where syntax is only indirectly relevant, discourse (cf. 15c,d). Within sentence grammar we might make a distinction between the domain in which predicate-based grammatical processes like passive apply (cf. 15a) versus the domain in which processes like *wh*-movement apply (cf. 15b). At the discourse level we distinguish discourse (15c) from deixis (cf. 15d), the latter being the more ‘local’ option in discourse.

- (15) For  $y$  = reflexive,  $x$  = antecedent of  $y$ :
- a. (complex) predicate/clause  
 .....[CP/IP ... $x$ ... $y$ ...] .....
  - b. sentence  
 [CP ... $x$ ... [CP ... $y$ ...] .....
  - c. deixis  
 [CP... $y$ ...]  
 ..... $x$ .....
  - d. discourse  
 [CP... $x$ ...] [CP.....] [CP... $y$ ...]

---

<sup>4</sup> Whether or not such generalizations hold true is not at issue here (cf. Everaert 1991).

In the Principles and Parameters theory, Lexical-Functional Grammar, Head-Phrase Structure Grammar, Binding Theory is focused on syntactic binding, limited to the predicational domain. Reflexives encode referential dependencies in the clausal domain, i.e. (15a). In all Binding Theories that I am acquainted with, with the exception of Reflexivity, there is room for debate whether (15b) could still be taken as a possible domain for regular ‘syntactic’ binding. But for all Binding Theories mentioned above, reference outside the sentence, i.e. (15c,d) is forbidden ground for anaphors (cf. Kang 1988 for discussion). For the domain of discourse, we exclusively have elements called pronouns, and the binding conditions have nothing to say about anaphoric dependencies in this domain.

Is there a reason to assume that anaphora are partitioned this way? In other words, is there reason to assume that we need more than the simple anaphor (for 15a) – pronoun (for 15b,c,d) distinction of BT? If we look at what defines an element as an ‘anaphor’ it is not straightforward that the anaphoric dependencies in (15a) and (15b) would be morpho-syntactically encoded differently from those in (15c) and (15d). It is not evident that a definition of anaphors rooted in Chomsky (1986) and Keenan (1988) according to which anaphors are referentially defective NPs predicts that reflexives could, for instance, never be taken as discourse anaphora (15d).<sup>5</sup> Only if reflexive anaphors were necessarily interpreted as bound variables, subject to a c-command/o-command/ syntactic rank restriction, the predicted discourse restrictions on reflexive anaphors would follow naturally from whatever explains the (un)grammaticality of the examples in (16):

- (16) a. *Every ex-husband* feared that *he* would be neglected  
 b. \*Because she hated *every ex-husband*, Mary would certainly tell Zelda why she left *him*  
 c. \**Every ex-husband* feared that I would be neglected. *He* ...

In other words, we generally assume that the preferred domain for a ‘reflexive’ is (15a). There is no a priori reason that this should be the case, but most languages (like Dutch, Spanish, Russian, etc.) mentioned above offer us this as the primary distinction.

In a sense, English is rather atypical, because its reflexive anaphor can be used in all domains. That is, it is often used in more structural configurations than we might consider calling reflexive environments:

---

<sup>5</sup> It has been observed that in various languages reflexives are used as honorifics. See Siewierska (2004: 224-228) for an overview on this particular, deictic, use of reflexives.

- (17) a. Predicate:  
Mary thinks that [*John saw himself*]
- b. Sentence:  
And that was exactly it, *he* thought. [*He* really didn't care too much  
[what happened to *himself*]]
- c. Deixis:  
There were five tourists in the room apart from *myself*
- d. Discourse:  
[Whom *he* [=Philip] was supposed to be fooling, *he* couldn't imagine].  
[Not the twins, surely, because Désirée, in the terrifying way of  
progressive American parents, believed in treating children like adults]  
and [had undoubtedly explained to them the precise nature of her  
relationship with *himself*].

With the fourfold distinction given in (15), we could, in principle, expect a language to make the following partitioning, giving every domain its unique identifiable anaphoric element:

- (18) a. anaphor<sub>1</sub>      for (15a)  
b. anaphor<sub>2</sub>      for (15b)  
c. pronoun<sub>3</sub>      for (15c)  
d. pronoun<sub>4</sub>      for (15d)

As far as I can tell there is no language that straightforwardly offers us this picture - four different forms - but there are many languages that offer a morpho-syntactic partitioning of anaphoric elements that is clearly different from the simple anaphor-pronoun distinction. In the following section I will give a very limited sketch of some of the diversity one may find.

#### 4. Anaphoric elements and their domains

The literature gives us overwhelming evidence that most/all languages seem to have an anaphor<sub>1</sub>-type. To give an example, take the Norwegian reflexive *seg selv*, which contrary to *seg*, can only be bound in its most immediate domain, as is shown by the contrast between (12a), here repeated, and (19):

- (12) a. *Jon bad oss hjelpe seg*  
          'John asked us to help him'
- (19)   \**Jon bad oss hjelpe seg selv*  
          'John asked us to help himself'

Likewise, reciprocals seem to be primarily clause-bound, as has been observed in Yang (1981).<sup>6</sup> This is illustrated for Kannada in (20) (Amritavalli 2000: 67,89):

- (20) a. [shyaama tannannu<sub>i</sub> priitisuttaane anta] raama<sub>i</sub> heeLidanu  
 Shyama self<sub>acc</sub> loves that Rama said  
 ‘Rama said that Shyama loves him (=Rama)’  
 b. \*makkaLu<sub>i</sub> [naanu obbaranna obbaru<sub>i</sub> baide anta] heeLidaru  
 children I one<sub>acc</sub> one<sub>nom</sub> scolded that said  
 ‘The children said that I scolded one another’

But what about the other anaphor/pronoun types that could, potentially, exist? A language like Tamil gives a good illustration of the point I want to make.<sup>7</sup>

#### 4.1 Tamil

Tamil, as described in (Lehmann 1989, Annamalai 2000), has two pronouns referring to 3<sup>rd</sup> person antecedents: *avan* (that one, he; 3<sup>rd</sup> Person, Masculine, Accusative, -Proximate) and *ivan* (this one, he; 3<sup>rd</sup> Person, Masculine, Accusative, +Proximate). In addition Tamil has a pronominal form *taan* (3<sup>rd</sup> Person, -Plural, not specified for gender), which could be taken as the equivalent of English *himself*.

(21-22) illustrate the binding properties of *taan*: *taan* cannot be discourse bound (cf 21), but intra-sentential reference is not restricted to the local domain (cf. 22a,b)

- (21) a. \*kamalaa avan *tann-ai* veru-kkir-aan en-ru ninai-tt-aa|  
 Kamala he self-acc hate-pres-3sm say-vbp think-pst-3sf  
 ‘Kamala thought that he hated him(=Kumaar)’  
 b. \*kumaar kaDekki poonan; ange *tanakku* oNNum piDikkale  
 Kumar shop to go-pst-agr there self to anything like not  
 ‘Kumar went to the shop; he did not like anything there.’  
 (22) a. kamalaa *avan tann-ai* veru-kkir-aan en-ru ninai-tt-aa|  
 Kamala he he-acc hate-pres-3sm say-vbp think-pst-3sf  
 ‘Kamala thought that he hated himself’  
 b. *kamalaa* avan *tann-ai* veru-kkir-aan en-ru ninai-tt-aa|  
 Kamala he she-acc hate-pres-3sm say-vbp think-pst-3sf  
 ‘Kamala thought that he hated her’

<sup>6</sup> Cf. Everaert 2005 for a discussion of this generalization.

<sup>7</sup> A similar partitioning of anaphoric elements and similar distributional facts hold for Malayalam, Bangla, Telugu (cf. Jayaseelan & Haripasad 2001).



In Lehmann (1989) *taan* is described as a 4th person pronoun: “the occurrence of *taan* in a reflexive construction is only one of its occurrences and there is, therefore, no justification to call it a reflexive pronoun [...] just because it can occur in a reflexive construction.” (p.97) In other words, because *taan* is not limited to the smallest domain (21a), but is regularly used in a wider domain (21b), like an anaphor<sub>2</sub> type, Lehmann does not want to call it a reflexive, contrary to Annamalai (2000).

In some cases, however, *taan* seems to behave like a true anaphor<sub>1</sub>-type, necessarily clause bound, as is shown in (23):

- (23) a. kumaar *umaa tanne* tiTTikiTTaaNNu sonnaan  
 Kumar Uma self-acc scold-pst-VR-pst-agr-that say-pst-agr  
 ‘Kumar said that Uma scolded himself’  
 b. \**kumaar* *umaa tanne* tiTTikiTTaaNNu sonnaan  
 Kumar Uma self-acc scold-pst-VR-pst-agr-that say-pst-agr  
 ‘Kumar said that Uma scolded himself’

Note, however, that it is the verbal auxiliary *kiDu* reflexive marking the embedded predicate, resulting in local binding (23a), blocking long-distance binding (cf. 23b).

The pronoun *avan* is the designated element for discourse binding (cf. 24a); local binding is excluded (24b), unless modified by an emphasis marker (24c):

- (24) a. *kumaar* kaDekki poonan; ange *avanukku* oNNum piDikkale  
 Kumar shop to go-pst-agr there he to anything like not  
 ‘Kumar went to the shop; he did not like anything there.’  
 b. \**kumaar avan-ai* veru-kkir-aan  
 Kumar he-Acc hate-pres-3sm  
 Kumar hates himself  
 c. *kumaar avaneyee* verukaan  
 Kumar he-acc-emph hate-prst-agr  
 ‘Kumar<sub>i</sub> hates himself<sub>i</sub>/him<sub>i</sub>’

The differences/similarities between the proximate/obviative pronouns becomes clear in (25-26). (25) shows that both pronouns can be used deictically, but that for sentence internal reference *ivan*, the proximate element, is excluded:

- (25) a. *ivan* en tampi

- (this)-he I(OBL) brother  
 ‘He is my brother’
- b. *avan* en *tampi*  
 (that)-he I(OBL) brother  
 ‘He is my brother’
- (26) a. *kumaar* *va-nt-aal* *naan* *avan-iTam* *collu-v-een*  
 Kumar come-cond I he-loc say-fu-1s  
 ‘If Kumar comes I will tell him’
- b. \**kumaar* *va-nt-aal* *naan* *ivan-iTam* *collu-v-een*  
 Kumar come-cond I he-loc say-fu-1s  
 ‘If Kumar comes I will tell him’

Summarizing we can say that *taan* is an anaphor<sub>2</sub> element that is used for sentence internal reference (cf 15b); *ivan* is a pronoun<sub>3</sub> element, used for deictic contexts only (15d)<sup>8</sup>; *avan* can be used for deixis, discourse binding and sentence internal binding (15b,c,d). Strict local binding (cf 15a) is only realized when the anaphor<sub>2</sub> element *taan* is combined with a verbal reflexive marker, making it a reflexively marked predicate in the sense of Reinhart & Reuland (1993).

#### 4.2 Roumenian and Mupun

There are other languages that, like, Tamil, seem to have a anaphor<sub>2</sub> element, whose distribution is defined as in (15b): the ‘reflexive’ *sine* in Roumenian (Sevcenco 2004) and the ‘logophoric pronoun’ *émi* in Fon (Kinyalolo 1993) and *dî* in Mupun (Frajzyngier 1997).<sup>9</sup> I will limit my brief discussion here to Roumenian and Mupun.

The distribution of the Romanian anaphor *sine* (Sevcenco 2004) shows that it can be bound in both local and long distance contexts, as in (27), which involves the occurrence of *sine* in a clitic doubling structure, and (28), which is ambiguous between the reading in which *Alex* is the antecedent of *sine* and another reading in which *George* is the antecedent:<sup>10</sup>

- (27) Directorul se admiră pe sine.  
 Director-the se REFL CL ACC admires 3SG pe PREP ACC self.  
 ‘The director admires himself’.

<sup>8</sup> All languages seem to morpho-syntactically encode indexicals like *I*, *we*, *you* of the pronoun<sub>4</sub> type.

<sup>9</sup> The fourth person pronouns in Mabaan as described in Andersen (1999) might offer another example.

<sup>10</sup> What is interesting is that Romanian seems to have no ‘logophoricity’ constraints, in the semantic sense. But does have blocking effects.

- (28) George vrea ca Alex să conteze on sine.  
 George wants that COMP SUBJ Alex să SUBJ count on self.  
 ‘George wants that Alex count on Alex/George’.

Logophoric systems are, generally, also defined by the domain given in (15b). The case of Mupun (Frajzyngier 1997) illustrates this:

- (29) a. *wu/wa/mo* sat nə ta *d̃i/d'è/d'ū* d'ee n-jos  
 he/she/they say COMP stop he/she/they stay prep-Jos  
 ‘He/she/they<sub>i</sub> said that he/she/they<sub>i</sub> stopped over in Jos’  
 b. *wu/wa/mo* sat nə ta *wù/wà/wà* d'ee n-jos  
 he/she/they say COMP stop he/she/they stay prep-Jos  
 ‘He/she/they<sub>i</sub> said that he/she/they<sub>j</sub> stopped over in Jos’

In (29a) the logophoric pronouns refer, necessarily, to the matrix subject. If one want to encode sentence external reference a regular pronoun is chose, as illustrated in (29b).

## 5. Conclusion

In the preceding section I have given some evidence for a richer classification of anaphoric elements that the anaphor-pronoun distinction. This is based on the assumption that we should distinguish four types of domains, as sketched in (15). Many languages indeed reflect these domains by morpho-syntactic encoding domain with dedicated anaphoric elements. The consequences for a proper formulation of the Binding theory are substantial. Given the postulation of four domains of anaphoric dependencies, and four anaphoric types, we might also need four binding conditions. However, not in the traditional sense of the word.

Anaphoric dependencies outside the scope of sentence grammar I leave undiscussed here. But, clearly, notions like Source, Self and Pivot, as introduced in Sells (1987) will play a crucial role.

For sentence grammar we, at least, need the equivalent of Principle Z, for instance:

- (30) An anaphor is bound (=c-commanded by a co-indexed element)

This condition applies to any element that is standardly called a reflexive/reciprocal, but it also holds for logophors, or ‘4<sup>th</sup> person’ pronouns. This condition gives no domain restriction other than that the antecedent must be a sentence internal c-commanding NP. The fact that certain anaphors have a

restricted choice of antecedents, a co-argument, is the result of reflexive marking of the predicate of which the anaphor is an argument. Reflexive marking is either overtly visible through verbal morphology, or covertly through incorporation of a reflexive-marker (cf. Reinhart & Reuland 1991, Anagnostopoulou & Everaert 1999), generally morpho-syntactically encoded on the anaphoric element itself. One could take (31) as a binding condition,

(31) A reflexive marked predicate must be reflexive

but this condition is different from (30) in that it not directly refers to the anaphoric element itself.

## References

- Anagnostopoulou, E. and M. Everaert. 1999. Towards a more complete typology of anaphoric expressions. *Linguistic Inquiry* 30.1, 97-118
- Andersen, T. 1999. Anti-logophoricity and indirect mode in Mabaan, *Studies in Language* 23, 499-530.
- Annamalai, E. 2000. Lexical Anaphors and pronouns in Tamil. In *Lexical pronouns and anaphors in selected South Asian languages: a principled typology*, ed. B. Lust, K. Wali, J. Gair and K.V. Subburao. Mouton De Gruyter.
- Branco, António and Palmira Marrafa. 1999. Long-distance Reflexives and the Binding Square of Opposition. In Gert Webelhuth, Jean-Pierre Koenig, and Andreas Kathol, editors, *Lexical and Constructional Aspects of Linguistics Explanation*. CSLI Publications, Stanford, chapter 11, pages 163–177.
- Branco, A. 2005. Anaphoric Constraints and Dualities in the Semantics of Nominals, *Journal of Logic, Language and Information*, 14, 149-171.
- Bresnan, J. 2002. *Lexical-Functional Syntax*. Oxford: Blackwell.
- Chomsky, N. 1981. *Lectures on Government and Binding*. Dordrecht: Foris
- Chomsky, N. 1986. *Knowledge of Language: its nature, origin and use*, New York: Praeger.
- Cole, P., G. Hermon and C.-T. J. Huang. 2001. *Long-distance reflexives*, Syntax and Semantics 33, San Diego, Academic Press.
- Everaert, M. 1986. *The Syntax of Reflexivization*. Foris, Dordrecht.
- Everaert, M. 1991. Contextual Determination of the Anaphor/Pronominal Distinction. In J. Koster and E. Reuland (eds.), *Long-distance Anaphora*. 49-76). Cambridge, UK: Cambridge University Press.

- Everaert, M. 2003. Binding Theories in the Generative Research Tradition, *Research in Language* 1, 33-52.
- Everaert, M. 2005. Long-Distance Reciprocals, ms Utrecht University
- Frajzyngier, Z. 1997. Pronouns and agreement: systems interaction in the coding of reference. *Atomism and binding*. H. Bennis, P. Pica, and J. Rooryck (eds). Dordrecht: Foris, 115-140.
- Harbert, W. 1983. On the Definition of Binding Domains. In *Proceedings of the West-Coast Conference of Formal Linguistics* 2, 102-113.
- Hornstein, N. 2001. *Move! A minimalist theory of construal*. Blackwell, 2001.
- Inoue, K. 1976, Reflexivization: an interpretive approach, In: M. Shibatani (ed.) *Syntax & Semantics* 5, Academic Press, New York.
- Jayaseelan, K.A. & M. Haripasad (2001) Deixis in Pronouns and Noun Phrases, *Linguistic Analysis* 31, 132-149.
- Kang, B.-M. 1988. Unbounded reflexives, *Linguistics & Philosophy* 13, 415-456.
- Keenan, E. 1988. On Semantics and the Binding Theory, In : J. Hawkins (ed.) *Explaining language universals*. Oxford: Blackwell, 105-144.
- Kinyalolo, K. 1993. The logophoric pronoun *émi* in Fon as an LF operator/anaphor. *Proceedings of NELS 23*. Amherst: GSLA, 223-237.
- Koster, J. & E. Reuland (eds) 1991. *Long-distance Anaphora*, Cambridge University Press, Cambridge.
- Lehmann, T. 1989. *A Grammar of Modern Tamil*. Pondicherry: Pondicherry Publications.
- Pica, P. 1985. Subject, Tense and Truth: Towards a Modular Approach to Binding. In J. Guéron, H. G. Obenauer, and J.-Y. Pollock (eds.), *Grammatical Representation*. Foris, Dordrecht, pp. 259-291.
- Pollard, C., and I. Sag. 1994. *Head-Driven Phrase Structure Grammar*. Stanford: CSLI, and Chicago: The University of Chicago Press.
- Reinhart, T. 1983, *Anaphora and Semantic Interpretation*, London & Sydney: Croom Helm.
- Reinhart, Tanya and Eric Reuland. 1991. Anaphors and Logophors: An Argument Structure Perspective. In *Long Distance Anaphora*, ed. Jan Koster and Eric Reuland, 283-321. Cambridge: Cambridge University Press
- Reinhart, T., & E. Reuland. 1993. "Reflexivity". *Linguistic Inquiry* 24.4: 657-720.
- Reis, M. 1976. Reflexivierung in deutsche A.c.I.-konstruktionen, Ein transformations-grammatisches Dilemma, *Papiere zur Linguistik* 9, 5-82.
- Reuland, E. & Everaert, M. 2001. Deconstructing Binding, In: M. Baltin & C. Collins (eds.) *The Handbook of Contemporary Syntactic Linguistics*. Blackwell, 634-670
- Thráinsson, H. 1976. Reflexives and Subjunctives in Icelandic, *Proceedings of NELS* 6, 225-239.

- Sells, Peter. 1987. Aspects of Logophoricity. *Linguistic Inquiry*, 18:445-479.
- Sevcenco, A. 2004. Long Distance Romanian Anaphors and the Blocking Effect, talk presented at *Discourse Anaphora and Anaphora Resolution*, S. Miguel, Azores – September 23-24, 2004
- Siewierska, A. 2004. *Person*. Cambridge, Cambridge University Press.
- Yang, D.-W. (1984). The Extended Binding Theory of Anaphors, *Theoretical Linguistic Research*, 1:195-218

# Implementing Norwegian reflexives in an HPSG grammar

Lars Hellan 

NTNU, Trondheim

Proceedings of the 12th International Conference on  
Head-Driven Phrase Structure Grammar

Department of Informatics, University of Lisbon

Stefan Müller (Editor)

2005

Stanford, CA: CSLI Publications

pages 519–539

Hellan, Lars. 2005. Implementing Norwegian reflexives in an HPSG grammar. In Stefan Müller (ed.), *Proceedings of the 12th International Conference on Head-Driven Phrase Structure Grammar, Department of Informatics, University of Lisbon*, 519–539. Stanford, CA: CSLI Publications. DOI: 10.21248/hpsg.2005.30.



## Abstract

The paper reviews basic patterns of reflexive binding in Norwegian, and explores a possible implementation of them in an HPSG grammar using the LKB platform. Norwegian has two reflexive elements, with distinct constraints and corresponding 'anti-binding' effects; they can cooccur but also occur independently. As over-all strategy for resolving reflexive binding we use one resembling the 'slash' procedure for wh-dependencies. Binding constraints are imposed partly through lexical specification, partly through phrasal combination rules. Challenges are noted residing in the possibility for sentences to contain an unbounded number of reflexives.

## 1 Introduction

Reflexive constructions in the Scandinavian languages obey a number of interacting constraints, involving factors such as linear order, c-command, finite vs. non-finite clausal domains, co-argumenthood, predication (the factor of the anaphor being contained in a phrasal unit predicated of the binder), thematic role hierarchies, and logophoricity. Moreover, the languages have two distinct reflexive elements which can combine, but also occur independently, and which each induces its own distinct 'anti-binding' ("Principle B"-) effects. HPSG being a framework aimed at enabling the integration of many levels of representation in a unified analysis, it is a promising candidate for accommodating the interplay of factors like those mentioned. The present paper explores an account of the phenomena for use in an HPSG grammar implementation using the LKB platform (Copestake 2002). A summary of the main phenomena as instantiated in Norwegian is given in section 2, and section 3 outlines strategies for encoding them in an LKB grammar. As the reflexive patterns are employed pervasively in the language, providing an account of them will have a high priority in a core grammar of Norwegian, and it will be shown that most aspects of the phenomena can be straightforwardly formalized using the strategies chosen. In subsection 3.4, though, we will note some clear challenges to the approach.

## 2 Empirical background

Like the other Scandinavian languages, Norwegian has two monomorphemic words that are inherently reflexive, in Norwegian taking the forms *selv* 'self', and *seg*, with the genitival form *sin*. *Seg* and *sin* are 3<sup>rd</sup> person forms. In 1<sup>st</sup> and 2<sup>nd</sup> person the corresponding forms coincide with their non-reflexive



counterparts, and for clarity of exposition we therefore largely use examples with the 3rd person forms. *Selv* is a constant form. These words may occur by themselves, but may also combine, in 3<sup>rd</sup> person as *seg selv*. The first four items listed in Fig 1 below are the NP type items to be called *reflexives*. For convenience, the words mentioned, when regarded as sub-NP items, may be referred to as *reflexive elements*, each such word representing the '+' variant of a binary feature, as informally indicated:

Fig 1. Four reflexives and one pronominal in Norwegian, as defined through binary features:

<i>Bare seg- reflexive</i>	<i>Possessive reflexive</i>	<i>Seg selv- reflexive</i>	<i>Pron-selv- reflexive</i>	<i>Pronominal</i>
NP	NP	NP	NP	NP
Refl-I +	Refl-I +	Refl-I +	Refl-I -	Refl-I -
Refl-II -	Refl-II -	Refl-II +	Refl-II +	Refl-II -
Poss -	Poss +	Poss -	Poss -	Poss -
<i>seg</i> 'him-/ herself'	<i>sin</i> 'his-/her own'	<i>seg selv</i> 'him-/' herself'	<i>ham selv</i> himself'	<i>ham</i> 'him'

The reflexive elements (i.e., *seg*, *sin* and *selv*) are associated with different conditions for wellformedness. The conditions associated with *selv* are fairly similar to those holding for English *self*, concerning mainly co-argumenthood. The conditions associated with *seg* and *sin* (the elements marked 'Refl-I +' in fig.1) will now be reviewed briefly, following in essence Hellan 1988.

## 2.1 'Short' vs. 'long' distance reflexives

Reflexives consisting solely of the elements *seg/sin* have the possibility of 'long distance' binding, as exemplified in (1): a *sin*-reflexive can be bound 'out of' the genitival position of an NP, and further out of an infinitival VP, as seen in (1b); a bare *seg*-reflexive can be bound out of an infinitival VP, as seen in (1a); neither of these reflexives can be bound across a finite clause boundary, as seen in (1c).

- (1) a. *Jon* ba meg snakke om *seg/ \*seg selv*  
Jon asked me to talk about him

- b. **Jon** ba meg snakke om gramatikken **sin**  
Jon asked me to talk about his grammar
- c. \***Jon** hørte at jeg snakket om **seg**/ gramatikken **sin**  
Jon heard that I talked about himself/his grammar

So-called 'short distance' binding includes at least the cases in (2):

- (2) a. **Jon** omtaler **seg selv**  
Jon talks-about himself
- b. **Jon** vasker **seg**  
Jon washes himself
- c. vi fortalte **Jon** om **ham selv**  
we told Jon about himself
- d. **Jon** fortalte oss om **seg selv**  
Jon told us about himself
- e. **Jon** løp **seg** ut av laget  
Jon ran himself out of the team
- f. **Jon** leser boken **sin**  
Jon reads his book
- g. **Jon** snakker om boken **sin**  
Jon talks about his book

In the cases (a)-(e) we may say that the binding relation obtains between *co-arguments*. In (a)-(c) and (e) this coincides with binder and bindee having a grammatical function related to the same lexical item. In (d), one standardly assumes that although the preposition may be said to have a semantics of its own, this semantics is here used to explicitly highlight one of the roles associated with the verb, so that in a semantic sense, the argument of the preposition is a coargument with the subject of the verb. In (e), such a relation of semantic co-argumenthood is absent, but a syntactic coargument relation holds. Notably, in (b) and (e) only a bare *seg*-anaphor is used, whereas the other cases have a reflexive with *selv*. To a large extent, one can maintain that *selv* is used only when semantic co-argumenthood obtains. The exceptional case is then (b). A generalization covering this case is that verbs expressing actions that are naturally or standardly of a type one performs on oneself, allow for the use of a bare *seg* as bound by a semantic (and syntactic) coargument. (The pattern in (b) also involves verbs whose bare *seg*-object may be obligatory or expletive or both (as in *skamme seg* 'be ashamed') - here semantic co-argumenthood may be seen as altogether absent, accounting for the lack of *selv*.)

In (f) and (g) *sin* is the 'possessor' argument relative to the expressed *possess* relation which has 'the book' as its 'possessed' argument; *sin* is therefore in neither case a coargument of *Jon*, neither syntactically nor semantically. Still

we count it as a 'short distance' anaphor here, as opposed to 'long distance' in (1b).

## 2.2 The Predication Condition on *seg/sin*

Crucial to reflexives composed with the elements *seg/sin* is the following condition:

- (3) Predication Condition on *seg/sin*:  
A reflexive *R* composed with the elements *seg/sin* has to be contained in a phrasal constituent understood as *predicated* of the binder of *R*.

This condition is distinct from a 'subject' condition, in that it licenses a construction like (4a), where the binder is syntactically an object; it is still distinct from a condition of 'any c-commanding item being licensed as binder', since it does not license (4b), where 'his money' is not an expression predicated on 'him':

- (4) a. Vi gjorde ham glad i **seg** selv  
we made him fond of himself  
b. ?\*Vi fratok ham pengene **sine**  
we took his money from him

It may be noted that this notion of 'predication' is not tied to specific thematic roles for the 'subject'; thus, also subjects in passive sentences can satisfy the predication condition, as in (5):

- (5) Jon ble skutt av naboen **sin**  
Jon was shot by his neighbor

The Predication Condition offers an account of the contrast in (6), under the assumption that in (a), *ut av haven sin* ('out of his garden') is in a sense predicated of *Jon*, whereas in (b), *inne i haven sin/hans* ('inside of his garden') is predicated of the kicking event as such, and not of *Jon*.<sup>1</sup>

---

<sup>1</sup>Accepting this point for a movement performed by (what is expressed through) the object of a verb, it will be reasonable to assume that directionals qualifying a subject are also predicated of the mover, and not the event as such. The case thus provides empirical support for the position taken in Beermann and Hellan (2004), following proposals of, e.g., Jackendoff 1990 as opposed to Kracht 2003.

- (6) a. Vi sparket Jon ut av haven **sin**  
 we kicked Jon out of his garden  
 b. Vi sparket Jon inne i haven **\*sin/** hans  
 we kicked Jon inside of his garden

In (a), thus, Jon follows the trajectory expressed by 'out of his garden', and ends up in a state describable as 'Jon be outside of his garden'. Hence *Jon* here fulfills the Predication Condition holding of *sin*, validating the binding constellation in (a), whereas in (b), this condition is violated as far as a binding relation between *Jon* and the PP containing *sin* is concerned.

### 2.3 'Anti-binding' effects

Languages to varying extents grammaticalize a tendency to, for each anaphoric item operative in a certain domain, excluding other potential anaphors from that domain. For English, which only has one reflexive element (*self*), this tendency is observed in what has become encoded as the 'Principle B' of the Chomsky 1981 Binding Theory. For Norwegian, which has the *two* reflexive elements *seg/sin* and *selv*, one would expect this tendency to materialize in two anti-binding effects, one for each reflexive element; and this one can observe: the *selv*-reflexive appears to induce an anti-binding constraint on bare *seg*, to the effect that such a reflexive can not be used within a coargument domain, and *seg/sin* induces a constraint to the effect that within a constellation where the Predication Constraint is satisfied, a reflexive with a *ham* as first element is excluded. These effects are exemplified in (7) and (8), respectively (all examples with a binding interpretation presupposed):

- (7) a. **\*Jon** omtaler *seg*  
 Jon talks-about himself  
 b. **\*vi** fortalte **Jon** om *ham*  
 we told Jon about himself  
 c. **\*Jon** fortalte oss om *seg*  
 Jon told us about himself
- (8) a. **\*Jon** omtaler *ham selv*  
 Jon talks-about himself  
 b. **\*Jon** vasker *ham*  
 Jon washes himself  
 c. **\*Jon** fortalte oss om *ham selv*  
 Jon told us about himself  
 d. **\*Jon** løp *ham* ut av laget  
 Jon ran himself out of the team

- e. \**Jon* leser boken *hans*  
Jon reads his book
- f. \**Jon* snakker om boken *hans*  
Jon talks about his book
- g. \*Vi gjorde *ham* glad i *ham* selv  
we made him fond of himself

For long distance patterns and the construction in (6a), both the *seg/sin* form and the *ham/hans* form are possible:

- (9) a. *Jon* ba meg snakke om *seg/ham*  
Jon asked me to talk about him
- b. *Jon* ba meg snakke om gramatikken *sin/hans*  
Jon asked me to talk about his grammar
- c. Vi sparket *Jon* ut av haven *sin/hans*  
we kicked Jon out of his garden

As far as syntactic determinants go, the alternations in (9) are free, however, a consistent observation throughout the literature is that the reflexive options have a subject-centered point of view expressed, in opposition to the options using a pronominal. With that factor taken into account, one could say that an anti-binding effect is at play here as well: in the 'logophoric' domain, only *seg/sin* can be used. An analogous reasoning can be applied concerning the status of the ungrammaticality of (7a), recalling the grammaticality of (2b), repeated:

- (2b) *Jon* vasker *seg*  
Jon washes himself

As noted above, the pattern in (2b) obtains for activities that are naturally, although not always necessarily, self-directed. Let's call such self-directed two-place relations lexically 'tamed', and the object simply 'tamed': the anti-binding effect observed in (7a), which is one induced by the availability of *selv*, is then one that obtains relative to *non*-tamed second arguments: *selv* is only used with non-tamed objects, and these are therefore also the ones that are 'defended' against other encodings. (For 'tamed' objects, like the *seg* in (2b), the anti-binding effect geared to the predication factor is demonstrated in (8b).)

The phenomena now mentioned constitute the more 'robust' patterns of reflexives in Norwegian, and are those that will be considered in the next section. Among important areas we have not touched on are 'reconstruction' effects related to wh-fronting of constituents containing reflexives, and possible more subtle effects of thematic role dominance, both topics which would naturally have been included in a more extensive overview.

### 3 Implementing the patterns

The LKB formalism is a rather restrictive version of typed feature formalism, disallowing negative constraints, disjunctive constraints and quantificational constraints (i.e., constraints of the form 'for some...' or 'for all...'). Assemblies of items are construed as lists, not sets. Possible loss of expressive power under such a formalism is compensated for by gain in efficiency (cf., e.g., Flickinger (2000)). Among the growing family of LKB based grammars (referred to as 'Matrix grammars') related to the 'HPSG Grammar Matrix' (Bender et al. 2000), is a grammar for Norwegian, *NorSource* (cf. [//www.ling.hf.ntnu.no/forskning/norsource/](http://www.ling.hf.ntnu.no/forskning/norsource/)), which constitutes a background and actual testbed for proposals under discussion, without however being explicitly invoked in the present exposition.

Anaphora has so far only to a small extent been reflected in the LKB grammars available; for some languages, this is in part because reflexivity is arguably a largely pragmatic phenomenon. In Norwegian, as the overview will have shown, reflexives and their anti-binding effects are firmly situated in the core grammar itself, and only marginally related to pragmatics; hence, they should be covered by a Norwegian grammar. As most of the modules present in the Norwegian anaphora system can be found in many other languages as well, the efforts going into this task hopefully may be of relevance also beyond Norwegian.

#### 3.1 Determining the 'locus' for anaphora resolution

Manning and Sag (1998), extending the design of Pollard and Sag (1994), propose ARG-ST as an appropriate construct for imposing binding conditions: this is a list, for each predicate expressed, of those of its arguments that are syntactically realized, ordered according to an 'obliqueness' hierarchy. An anaphor, according to these proposals, is acceptable under two circumstances: if it occurs non-initially on its ARG-ST list, its binder must be an item preceding it on that list; and if initial, its interpretation is free. This account does not seem very relevant for the phenomena we have seen: constructions like (1a,b), repeated as (10a,b), and (2f,g), repeated as (10c,d),

- (10) a. *Jon* ba meg snakke om *seg*  
Jon asked me to talk about him  
b. *Jon* ba meg snakke om gramatikken *sin*  
Jon asked me to talk about his grammar  
c. *Jon* leser boken *sin*  
Jon reads his book

- d. *Jon snakker om boken sin*  
Jon talks about his book

show that grammatically necessary antecedents may appear outside of the local domain represented by a single ARG-ST list; (10c,d) also show that items initial on an ARG-ST list (as a possessor argument perhaps is) are by no means necessarily free in their interpretation.<sup>2</sup>

The general strategy for anaphora resolution to be envisaged here is somewhat traditional relative to an HPSG/GPSG setting (resembling, for instance, the 'slash' strategy for wh-dependencies; it may also be seen as compatible with proposals in Branco 2001): Each anaphor, as encountered by the phrasal combination rules, is 'stored' with its critical information: a reference index, its agreement features, and its feature characterization in terms of the possibilities given in fig. 1. When, in a later (higher) combination rule, a putative binder is encountered, then, given match in agreement features and acceptance of the 'REFL-I/REFL-II' constellation relative to the putative binder, the indices of the putative binder and the reflexive are identified and the 'store' containing the anaphor information is emptied. By technical assumption, no non-emptied store can be present at the final combinatorial stage. We now consider how to implement these conceived moves one by one.

Given strict locality of combinatory rules, to enforce that no *selv*-anaphor can be long distance bound (cf. (1a)), a rule combining a (non-auxiliary) V with a VP will have to impose as a general restriction that any reflexive to be carried up in the 'store' from this point on has to be a non-*selv* reflexive - i.e., one with the feature 'REFL-II -'. I.e., we may envisage a combination rule of the following form:

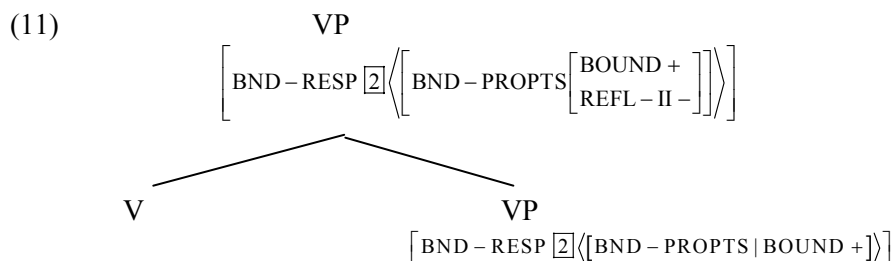

'BND-RESP' here introduces the package of information about the reflexive for which the structure has a 'binding responsibility'; it is stated as a singleton list, to allow expression of the possibility that there be no item under such a responsibility (and also that there be more than one - cf. 3.4 below). 'BOUND +'

<sup>2</sup> Although no mention will be made of ARG-ST or similar devices in what follows, we are not precluding that it may be relevant at some level of analysis, for instance, for incorporation of an account of role dominance (cf. end of section 2).

indicates that the reflexive must be bound. A structure where a *selv*-anaphor has not been bound by the point where the rule (11) applies, will fail unification. Hence, for the rule which technically resolves the anaphor (such as (12) below), it is, in this respect, enough that the structure is wellformed up to that point; for the rule in question, what remains is to identify indices and check for agreement. If we assume, along with Pollard and Sag op.cit., that agreement features are actually part of the referential index, the operation of the 'binding' rule will be essentially as indicated in (12):

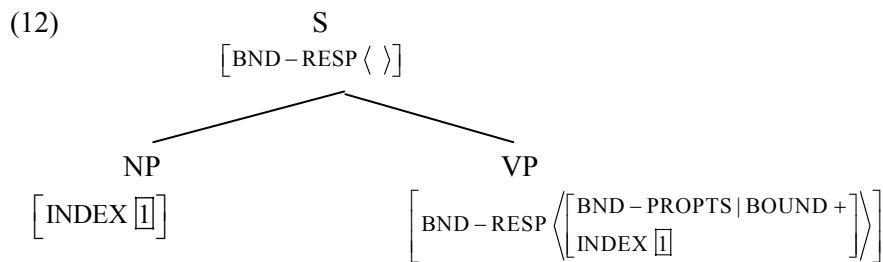

If we assume that bound occurrences of pronominals are marked with the specification 'BOUND +', then (12) will subsume their resolution as well.

For the constellation where an S combines with a finite complementizer, an effect similar to that in (11) obtains, now in addition requiring that REFL-I also be 'minus'. Thereby, no reflexive can be bound across a finite S-boundary.

The above is the gist of a procedure, and the next steps will be to show how it accommodates more of the various properties of Norwegian reflexives mentioned above. To begin with, let us assume the structure has only one reflexive. The first step is to 'mount' this reflexive in the BND-RESP list of that part of the structure which will be propagated up through the combinatorial steps. Let us assume - as is also typically the case - that this part of the structure is a head of which the reflexive acts as a complement. The 'mounting' step can then be portrayed as in (13):

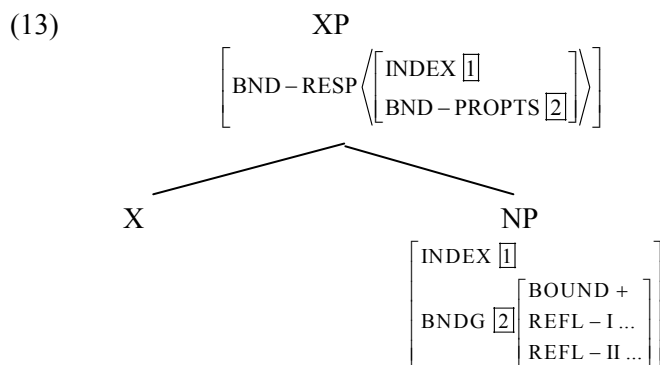



Every NP has a specification with regard to the features introduced inside the BNDG feature, indicating its binding potentials. Every NP also has an INDEX (actually introduced much deeper inside a feature path than we need to expose at this point - see (21) below). The dominating node encapsulates these pieces of information inside its feature BND-RESP.

The sequence (13)-(11)-(12) gives a first rough sketch of how an anaphor can be technically resolved. Relative to this picture, we in the next two sections consider how to implement 'anti-binding' effects for bare *seg*-reflexives and how to impose the Predication Condition and its 'anti'-counterpart. After that, we address how the procedure deals with the presence of more than one reflexive in a given structure, and possibly bound by different antecedents.

### 3.2 Implementing 'anti-binding' effects

Suppose that the anaphor is the bare *seg*; if the NP is 'non-tamed', the rules should license a structure like (14a), but at the same time (14b) should be blocked, both repeated from earlier:

- (14) a. **Jon** ba meg snakke om *seg*  
 Jon asked me to talk about him  
 b. \***Jon** omtaler *seg*  
 Jon talks-about himself

Thus, we now need to account for the anti-binding effect induced by *selv*, to rule out (14b); but we at the same time must enable a successful derivation of (14a). To achieve this, we introduce a device of 'provisional mounting', by which *seg* in (14a), as realizing an NP marked as 'non-tamed', is put on a waiting list for entrance to the dominating node's BND-RESP; (15) indicates how this may be expressed.

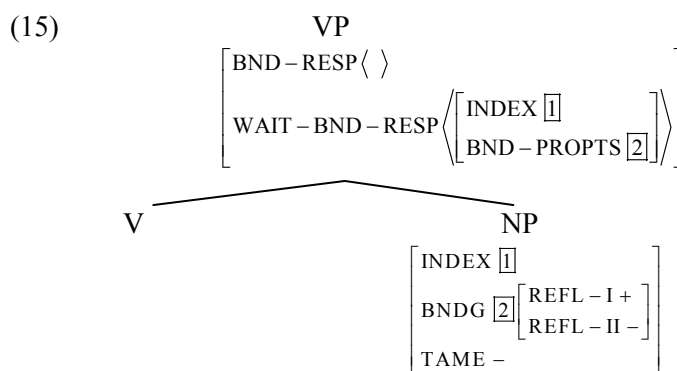

If the VP in (15) is combined with a subject, that subject will not be in a position to bind the reflexive, since (12) induces binding only for items inside BND-RESP. In this way, (14b) is excluded, the anti-binding effect induced by *selv* being enforced.

For cases like *vaske seg*, in contrast, where the verb frame defines the object as 'TAME +', we will assume that the reflexive is put directly on the BND-RESP list, thereby accepting these kinds of bare *seg*.

In the configuration pictured in (11), the reflexive specification can be shifted out of the 'waiting list' and into BND-RESP list. (11) is thus instantiated as (16) (- technically, (16) can be construed as a subtype of (11)). Thereby, (14a) can now be derived, the reflexive now being in the BND-RESP list proper:

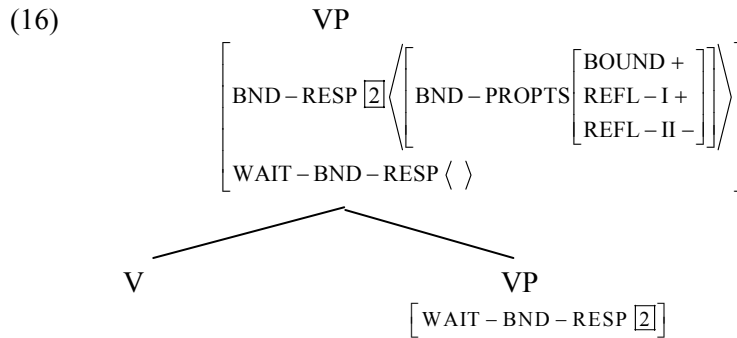

How, then, next, do we impose the anti-binding effect tied to *seg/sin*, excluding anaphors with *ham* from being predication-contained relative to their antecedent? One strategy will be to specify rules like (12), whose domain is one where the Predication Condition relative to a reflexive inside the VP is met, to exclude a pron-reflexive from its scope. It should be noted that a plain pronominal, when being in a distinct finite domain from the binder, can well be bound by a subject - the exclusion effect obtains only when *ham* is part of a reflexive. The refinement of (12) thus could consist of an exclusion of the package '[REFL-I -, REFL-II +]'. However, the exclusion effect comprises also possessive items - in the relevant domain, they must be *sin*, not *hans*, and neither form is '[REFL-II +]'. Hence, a further feature has to be added, vz. 'REFL bool', and the amendment of (12) inducing the anti-binding effect will be as in (17), whereas a possible rule inducing binding of pronominals may have the form of (18):

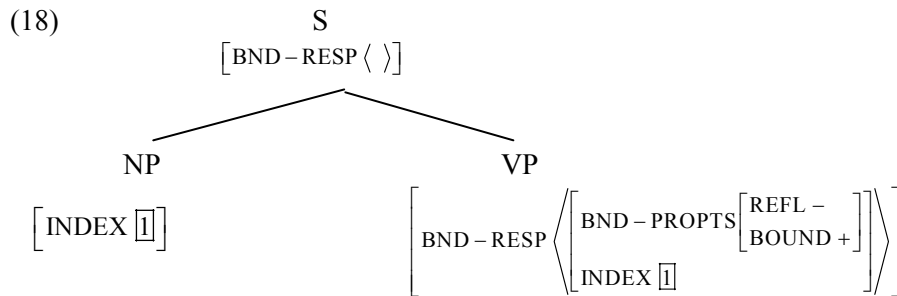
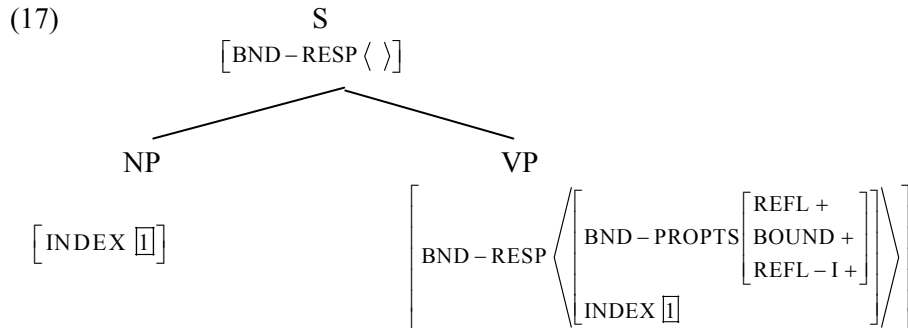

Since, other things being equal, having one unique rule for all binding-by-subject would have been preferable, we have to count this as a possible complexity. Moreover, in the formalism we are using, a rule of subject-VP combination distinct from both (17) and (18) is needed for the case where there is no item in the VP to be bound by the subject - the LKB formalism does not allow conditional rules. So, the 'count' of subject-VP rules stands potentially at three, at the moment.

Pursuing the strategy of (17), we need to identify all constellations where a potential binder combines with a VP or other XP predicated of it. This will include those exemplified (4a) and (6a), repeated in (19a,b), along with further instances in (19), all cases where the binder is syntactically a direct object (and a binding interpretation is understood/probed):

- (19)
- a. Vi gjorde *ham* glad i *seg selv*/ \**ham selv*  
we made him fond of himself
  - b. Vi sparket *Jon* ut av haven *sin*/ \**hans*  
we kicked Jon out of his garden
  - c. Vi hørte *Jon* snakke om pengene *sine*/ \**hans*  
we heard Jon talk about his money
  - d. Vi ba *Jon* snakke om pengene *sine*/ \**hans*  
we asked Jon to talk about his money

Whether or not all of these constellations can be subsumed under one rule, it or they will include a specification like that found for the VP in (17). And the proliferation necessitated for cases where a pronominal is to be bound, and where no item is to be bound, is repeated at this level. Crucially not covered by the rule(s) in question is the constellation in (20a,b), where an indirect object binds into a direct object; here the relevant specification will be as indicated in (20c), where the dotted area will include the binder, although in a way we will not try to make more precise at this point, as it involves technicalities arising from a consistently binary branching view of phrasal structure:

- (20) a. Vi fratok ham pengene **hans/ \*sine**  
 we took his money from him
- b. Vi fratok Jon **ham selv / \*seg selv**  
 we from-took Jon himself  
 'we deprived Jon of himself'
- c.
- $$\begin{array}{c}
 \text{VP} \\
 [ \text{BND} - \text{RESP} \langle \ \rangle ] \\
 \swarrow \quad \searrow \\
 \dots \quad \text{NP} \\
 \left[ \text{BND} - \text{RESP} \left\langle \left[ \text{BND} - \text{PROPTS} \left[ \begin{array}{l} \text{REFL} + \\ \text{BOUND} + \\ \text{REFL} - \text{I} - \end{array} \right] \right] \right\rangle \right]
 \end{array}$$

Summarizing, we have suggested implementing anti-binding effects in essentially two ways: those relating to *selv* are enforced through the mounting rule (15) and the phrasal combination rule (16) (and possible counterparts for configurations we have not looked at here), whereas those relating to the predication condition are enforced through the statement of the binding rules themselves, such as (17), its counterpart for cases like (19), and (20c).

### 3.3 A unified implementation of the Predication Condition?

Ideally, one would like the Predication Condition as stated in (3) to be implementable in one single specification in the grammar. In general, LKB grammars allow generalizations to come out either through type inheritance - a supertype encodes what is common to the subtypes - or through unary rules - a certain specification sits in the input to one or more unary rules each producing

different structures/types/rules, but all preserving the input specification in question. In the present context, this is to say that either, rules like those portrayed in (17) and (20c) could be construed as subtypes of a given type, or they could be constructed off from some sort of 'basic' binding rule covering the Predication constellation. Either way, one would need to abstract away from the specific configurational or functional status of the binders - such as the status of subject/sister of VP in (17) - and identify a status corresponding to 'predicate' and 'predication subject'. Let us consider how this could be done.

Arguably, adjectives like *glad* in (4a) (*Vi gjorde ham glad i seg selv* 'we made him fond of himself') are not valence defined for a subject, but they do have a semantic representation of a 'logical subject', something which in the Matrix grammars is entered as an ARG1 of the predicate in its semantic specification. Also verbs have an ARG1, often corresponding to their subject; however, in passive constructions, the ARG1 systematically is not what is expressed as subject, still, also subjects in passive sentences can bind a reflexive, as in (5) (*Jon ble skutt av naboen sin* 'Jon was shot by his neighbor'). In the framework in question, a common denominator for these options is XARG: for a verbal lexeme, this is the participant expressed by the (surface) subject, and for non-verbal lexemes, it is identical to its ARG1. Using these terms, the Predication Condition will require, for any reflexive *R* composed with *seg/sin*, that its binder have a status as XARG. To illustrate, in the 'generalized type' of binding rule imposing the Predication Condition (of which the case instantiated in (17) would be a subtype, or a 'unary rule' derivative), one thus would envisage the partial specifications in (21) (to stay faithful to the actual formalism, we show the full feature paths introducing XARG and INDEX) :

(21)

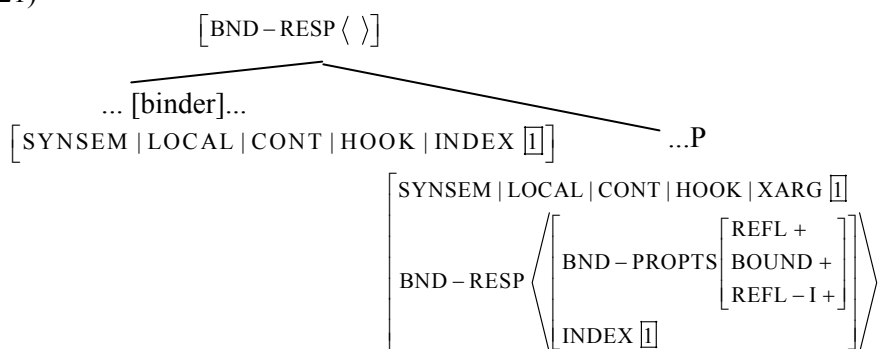

Since a direct object does not have the preceding indirect object as its XARG, the structure in (20) would not satisfy the specification in (21), and so would not inherit the 'Predication Condition' type.

Whether a supertype like (21) can realistically be constructed relative to the relevant rules in the grammar, is a question that goes beyond the scope of the present discussion; however, it is reasonably clear what we would be looking for. The same goes for a unary rule utilization of such an underspecified representation.

The reasoning around (21) warrants a slight digression. The procedure conceptualized presupposes a general one-to-one correspondence between NP tokens in a sentence and ref-indices representing the NPs in the semantic representation. In the standard procedures of assigning semantic representations to sentences, this is indeed obeyed, but an anaphor and its binder are traditionally assumed to share referential index; here, thus, there is no one-to-one-correspondence NP - referential index being made. However, somewhat subtle situations can arise where exactly this might be desirable. Consider the contrast in (22), where in (22a), the lines indicate licensing relations that are per se acceptable:

- (22)
- |    |                                       |
|----|---------------------------------------|
|    | ┌──────────────────────────┐          |
|    | │                          │          |
| a. | *Jon hørte seg selv snakke om seg     |
|    | Jon heard himself talk about himself  |
| b. | Jon hørte seg selv snakke om seg selv |
|    | Jon heard himself talk about himself  |

Underlying this contrast seems to be a constraint to the effect that if two reflexives are licensed as bound by the same NP, but are arguments of different predicates, then for the second of the reflexives it must also be verified that it is licensed as bound by the first of the reflexives. In (22a), *seg* indeed cannot be bound by *seg selv*, due to the 'long distance' requirement inherent in bare *seg* (as 'non-tamed'). In checking if *seg selv* in (22a) is an eligible binder of *seg*, it is crucial that it is the potential XARG status (relative to *snakke*) of *seg selv* we are checking, and not that of *Jon*. But if these have the same referential index, it is not obvious how to formally guarantee this.

Two options present themselves for resolving this kind of situation. One is to let the binding rules introduce explicit *identity relations between indices*, thereby letting each referential index be unique to one NP token. Another might be to rely on a bottom-up application of binding rules, by which the second reflexive in (22) would be necessarily first related to the first reflexive for possible binding, if these were to be represented as coreferential with each other at all. At this point, we just state these possibilities.

### 3.4 Dealing with multiple reflexives

The limitation to one reflexive per sentence, as we adopted in the previous paragraphs, is not representative of how reflexives occur in Norwegian. (23) are examples where two reflexives share a binder, whereas in (24), each reflexive has a different binder (in (b), as one of two readings):

- (23) a. **Jon** omtaler **seg selv** i alle **sine** bøker  
 'Jon mentions himself in all his books'  
 b. **Jon** så **sine** motstandere komme mot **seg**  
 'Jon saw his adversaries coming against him'
- (24) a. **Jon** så **meg** krysse **seg** ut av registeret **mitt**  
 'Jon saw me crossing him out of my register'  
 b. **Jon** ba **Marit** fortelle **seg** om **sine** opplevelser  
 'Jon asked Marit to tell him about her experiences'

As the discussion has already shown, the propagation of reflexive specification can come from all sorts of constituents: VPs, PPs, NPs, and any depth of embedding of NPs within PPs, for instance. Defining BND-RESP as taking a *list* as value seems in principle the right choice, since a given constituent can host many reflexives. Composition of lists from lists through the phrasal combinatorics technically will have to deal with what is called 'difference lists', informally marked as '<!...!>' rather than '<...>'. Acceptance of a sentence will require an empty such list in the end. We now consider how this can be obtained.

By assumption, (23a), repeated as (25a), may have a difference list of the form (25b) by the time a first binding rule (such as (17)) comes into operation:

- (25) a. **Jon** omtaler **seg selv** i alle **sine** bøker  
 'Jon mentions himself in all his books'
- b.
- $$\text{BND-RESP} \left\langle ! \left[ \text{BND-PROPTS} \begin{bmatrix} \text{REFL-I+} \\ \text{REFL-II+} \end{bmatrix} \right], \left[ \text{BND-PROPTS} \begin{bmatrix} \text{REFL-I+} \\ \text{REFL-II-} \end{bmatrix} \right] ! \right\rangle$$

The exact order in which the items appear on the list will depend on which head projection one starts with, and on whether new items are (on lists) prefixed or suffixed to the existing list; the order in (b) results, e.g., if one starts with the verb projection, and suffixes new items. A binding rule will, technically, have to address difference lists rather than lists. Suppose that we amend (17) minimally

(as (17')) to meet this requirement; the operation informally indicated is that of removing the *first* item on the VP's BND-RESP list:

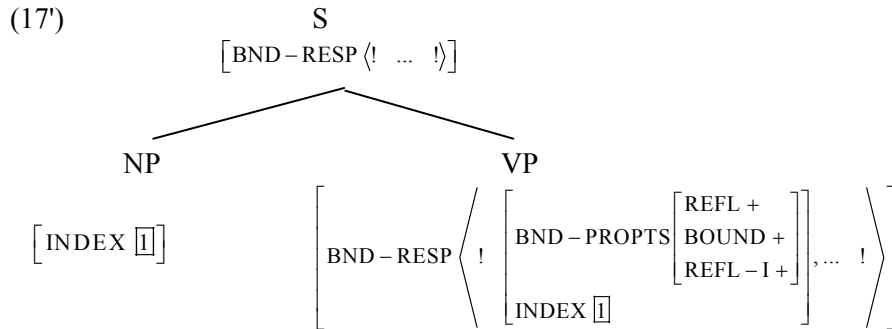

By its underspecification regarding 'REFL-II', it might seem that (17') should be able to apply to either item on the list in (25b) - a not unnatural way of conceiving the operation of this rule could indeed be that it applies to *all* items on the list satisfying its description. The INDEX of the subject NP being constant, this would mean inducing the same binder for both of the reflexives, which in this case would be correct as far as the reading is concerned. The obvious problem is that in the LKB architecture, such quantification over 'all items' is illicit - a rule can apply only to specific parts of a structure, for which it is explicitly declared. Thus, as it stands, (17') can apply only to the first item on the list. Since (17') defines a subject-VP combination, moreover, and there is only one subject, the rule cannot be reiterated. Thus, to get both items in the list in (25b) bound by the same subject, an alternative binding rule will have to be applied, explicitly binding the *first two* items on the list - cf. (17''):

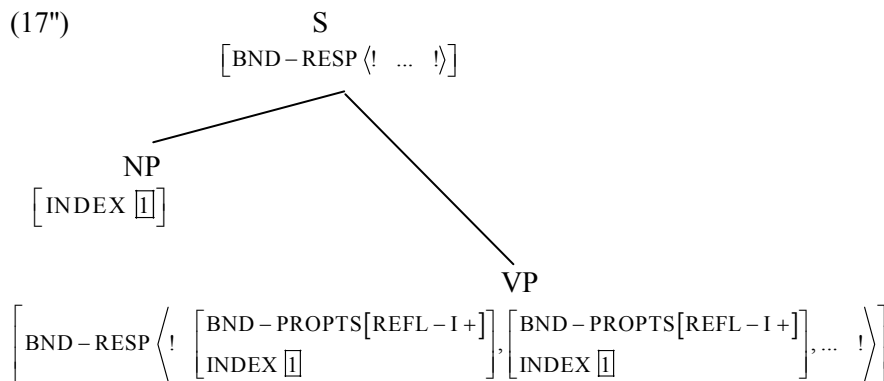

In (24b) (repeated), in turn, on the reading indicated,



- (24b) **Jon** ba **Marit** fortelle **seg** om **sine** opplevelser  
 'Jon asked Marit to tell him about her experiences'

the VP "fortelle **seg** om **sine** opplevelser" will have a 2-membered list where, to represent this reading, we want the binding by *Marit* to apply only to the *second* item on the list. We thus need a VP specification in the binding rule as in (26), removing only the second item from the list:

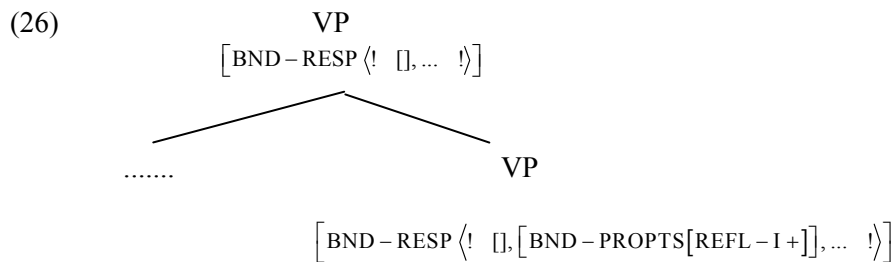

There is in principle no end to how many reflexives a binder may have to resolve - an indication is given in (27a), where the VP combining with *Jon* has four items - or how far out in a BND-RESP sequence a rule may have to go in order to select a reflexive licit on a given reading - in (27b), this is the third in the list under the VP starting with *beskrive*, and on another interpretation it could be number two and three, for instance - it is especially the possessive reflexives which can bring the number up in these ways:

(27)

a.

Jon satte **sin** bok om **sine** tvister med naboen **sin** aller høyest i **sitt** forfatterskap  
 'Jon valued his book about his controversies with his neighbor highest of his writings'

b.

**Marit** ba Jon beskrive **sin** bok om **sine** tvister med naboen **sin** som den aller beste i **sitt** forfatterskap

'Marit asked Jon to describe his book about his controversies with her neighbor as the very best of his writings'

For the strategy we are pursuing, the numbers now alluded to would be enlarged if we also treat pronominal binding by this same mechanism, and for every relevant configuration, there is of course also a rule for the case where BND-RESP is empty. We have been vague about how many binding configurations there actually are - for instance, the NP internal domains have not been mentioned - and the possibilities of generalizing over constellations are not

settled, as indicated in the discussion in 3.3. (And even for such a straightforward constellation as subject-VP, it is not to be taken for granted that main and subordinate clauses can be treated by a uniform rule, or inverted and non-inverted structures - but they all unfold the same possibilities of reflexive binding.)

For an implemented grammar using the design in question, it seems clear that an attempted coverage of all possibilities would constitute too much of a load on the grammar. For a grammar of Norwegian, it is equally clear that failing to cope with reflexives altogether makes the grammar inadequate. For what we have called 'tamed' reflexives, the device of augmented lexical frames will work, but these constructions cover only a small part of the domain, so some steps need to be taken to accommodate patterns with 'non-tamed' reflexives. Rules of the types in (17), (17') and (17'') then have to be adopted, and it will be a calibration question at what number of reflexives per sentence (such as, for instance, two) and on how many positions in a list, to set the limit.<sup>3</sup>

## 4 Conclusion

The article has laid out the rather complex patterns of Norwegian reflexives for accommodation in the restrictive typed feature formalism of the LKB/ Matrix systems. On the one hand, we have shown that constraints tied to both types of reflexive elements, as well as their anti-binding effects, can be concisely formalized - this holds both of domain-size constraints (co-argumenthood) and containment constraints (predication). On the other hand, in dealing with patterns of multiple reflexives, we have seen that the strategy chosen may face challenges in the form of rule proliferation.

## References

- Beermann, Dorothee, and Lars Hellan. 2004. A treatment of Directionals in two implemented HPSG grammars. In Stefan Müller (ed) *Proceedings of the HPSG04 Conference*. Center for Computational Linguistics, Katholieke Universiteit Leuven. CSLI Publications /<http://csli-publications.stanford.edu/>
- Bender, Emily, Daniel Flickinger and Stephan Oepen. 2002. The Grammar Matrix: An open-source starter-kit for the rapid development of cross-linguistically consistent broad-coverage precision grammars. In: *Proceedings of the Workshop on Grammar Engineering and Evaluation at*

---

<sup>3</sup> Aside from presenting challenges within the LKB design, these phenomena may also invite to comparison with other platforms or architectures that could provide a more expressive formalism, such as TRALE (cf. Meurers et al. (2002)).

- the 19th International Conference on Computational Linguistics*, 8-14, Taipeh, Taiwan.
- Branco, António. 2001. Without an Index: a lexicalist account of binding theory. In Frank van Eynde, Dorothee Beermann and Lars Hellan (eds) *Proceedings of the HPSG Conference 2001*, NTNU, Trondheim. CSLI Publications /<http://csli-publications.stanford.edu/>
- Chomsky, Noam. 1981. *Lectures on Government and Binding*. Foris Publications, Dordrecht.
- Copestake, Ann. 2002. *Implementing Typed Feature Structure Grammars*. CSLI Publications.
- Flickinger, Daniel. 2000. On building a more efficient grammar by exploiting types. *Natural Language Engineering* 6(1): 15-28, Cambridge University Press.
- Hellan, Lars. 1988. *Anaphora in Norwegian and the Theory of Grammar*. Foris Publications, Dordrecht.
- Jackendoff, Ray. 1990. *Semantic Structures* MIT Press.
- Kracht, Marcus. 2002. On the Semantics of Locatives. *Linguistics and Philosophy* 25: 157-232.
- Manning, Christopher, and Ivan Sag. 1998. Argument Structure, Valence and Binding. In *Nordic Journal of Linguistics*, 21, 107-144.
- Meurers, Detmar, Gerald Penn and Frank Richter. 2002. A Web-Based Instructional Platform for Constraint-Based Grammar Formalisms and Parsing. In: Dragomir Radev and Chris Brew (eds) *Effective Tools and Methodologies for Teaching NLP and CL*, 18-25. The Association for Computational Linguistics. New Brunswick, NJ.
- Pollard, Carl and Ivan Sag. 1994. *Head-Driven Phrase Structure Grammar*. Chicago Univ. Press.

# Semantic composition in reflexivization

Tohru Noguchi

Ochanomizu University, Japan

Proceedings of the 12th International Conference on  
Head-Driven Phrase Structure Grammar

Department of Informatics, University of Lisbon

Stefan Müller (Editor)

2005

Stanford, CA: CSLI Publications

pages 540–560

Noguchi, Tohru. 2005. Semantic composition in reflexivization. In Stefan Müller (ed.), *Proceedings of the 12th International Conference on Head-Driven Phrase Structure Grammar, Department of Informatics, University of Lisbon*, 540–560. Stanford, CA: CSLI Publications. DOI: 10.21248/hpsg.2005.31. 

## Abstract

It has been commonly assumed since Chomsky (1981) that the distribution of reflexive pronouns is subject to Binding Condition A. Reinhart and Reuland (1993) formulate Condition A in terms of the notion of “syntactic predicate.” The proposal I will develop in this paper is to factor out semantic and syntactic conditions on the occurrence of reflexive pronouns and to reduce them to independently motivated semantic and syntactic mechanisms. The semantic part is attributed to a theory of semantic composition recently developed by Chung and Ladusaw (2004), while the syntactic residue falls into the proper characterization of syntactic chains, as proposed by Reinhart and Reuland (1993) and Reuland (2001). To the extent that this approach is successful, Binding Condition A is rendered superfluous.\*

## 1. Introduction

It has been commonly assumed since Chomsky (1981) that the distribution of reflexive pronouns is subject to Binding Condition A. Reinhart and Reuland (= R&R) (1993) formulate Binding Conditions A and B as follows:

- (1) *Conditions* (= R&R’s (41))  
A: A reflexive-marked syntactic predicate is reflexive.  
B: A reflexive semantic predicate is reflexive-marked.

Note that while Condition B is defined in terms of “semantic predicate,” Condition A is defined in terms of “syntactic predicate.” One might wonder why the semantic notion of “reflexivity” needs to be characterized in two different terms. If “reflexivity” is about predicates, then Condition B seems natural. But the same thing cannot be said about Condition A; “predicate” is essentially a semantic notion, which R&R redesign in syntactic terms.

The proposal I would like to develop in this paper is to factor out semantic and syntactic conditions on the occurrence of reflexive pronouns and to reduce them to independently motivated semantic and syntactic mechanisms. The semantic part is attributed to a theory of semantic composition recently

---

\* I would like to thank the participants in the Workshop on Binding Theory and Invariants in Anaphoric Relations, especially Eric Reuland, Jeff Runner, and Ivan Sag, for helpful comments and suggestions. Comments from three anonymous reviewers of the abstract of this paper were also very helpful. Earlier versions of this paper were presented at the University of Tokyo (July, 2002) and at the 26<sup>th</sup> GLOW Colloquium in Lund, Sweden (April, 2003). I have benefited from discussion with the audiences there as well as Noriko Imanishi, Yuki Ishihara, Noriko Kawasaki, Chisato Kitagawa, Peggy Speas. Needless to say, any remaining errors are my own. This research was supported in part by Grants-in-Aid from Japan Society for the Promotion of Science #15520308.

developed by Chung and Ladusaw (2004) (= C&L). The syntactic residue falls into the proper characterization of syntactic chains, as formulated by R&R (1993) and elaborated by Reuland (2001). To the extent that this approach is successful, Condition A can be rendered superfluous.

This paper is organized in the following manner. In Section 2, I will outline the interpretive mechanism proposed by C&L. In Section 3, I will discuss the core case of reflexive anaphora and provide an analysis in terms of the mode of composition Restrict. In Section 4, I will discuss the other cases of reflexive anaphora and provide an analysis in terms of the mode of composition Specify, while reducing the syntactic residue to a syntactic chain formation. In Section 5, I will extend the empirical domain to cover a range of phenomena other than reflexive anaphora to show that the proposal has a wider applicability. The discussion concludes in Section 6.

## 2. Chung and Ladusaw (2004)

The work by Kamp (1981) and Heim (1982) has shown that definite and indefinite NPs in languages like English are interpreted as free variables whose domain is restricted by the semantic content of the common noun. C&L propose an alternative and argue that indefinite NPs compose with a predicate in two different manners, i.e. either via the nonsaturating mode of “Restrict” or the saturating mode of “Specify.”

The basic question addressed by C&L is whether the predicate-argument relation is necessarily captured in terms of saturation, i.e. by reducing the degree of incompleteness of a predicate by one. Consider a sentence like (2), where the transitive verb, semantically of type  $\langle e, \langle e, t \rangle \rangle$ , takes an indefinite NP, semantically of type  $\langle e, t \rangle$ , as one of its arguments.

(2) John fed a dog.

Since the type of argument here is not the one that the predicate looks for, there is a type mismatch. C&L argue that there are two ways to resolve the tension. One is to invoke type-shifting in the sense of Partee (1986), whereby the semantic type of an expression can be shifted into an appropriate one. C&L propose to formulate it in terms of a choice function that takes a property-denoting expression and maps it into an entity that has that property (cf. Reinhart 1997, Winter 1997, Kratzer 1998). Reinhart (1997: 372) defines choice function as follows:

(3) A function  $f$  is a choice function (CH ( $f$ )) if it applies to any non-empty set and yields a member of that set.

Once a choice function applies to a property-denoting expression and yields an entity, the composition proceeds in the usual manner. The mode of composition in terms of choice function is what C&L call “Specify”; the

logical representation of (2) is given in (4).<sup>1</sup>

(4)  $\exists f[\text{feed}'(f(\text{dog}'))(j)]$

The use of a choice function is represented by a function variable, which is existentially closed; the formula represents the proposition that there is a choice function  $f$  such that the dog it picks is fed by John. C&L follow Reinhart (1997) and Winter (1997) in assuming that existential closure of function variables applies at any compositional level, which accounts for a variety of scope behavior of indefinites.<sup>2</sup>

The other way of resolving the type mismatch noted above is to interpret the indefinite NP as a predicate modifier. In this mode of composition which C&L call “Restrict,” the property-denoting expression directly composes with a predicate, without saturating any of the predicate’s argument positions.<sup>3</sup> (2) is translated into the formula in (5), and applying  $\lambda$ -conversion and existential closure yields a representation like (6).

(5)  $\lambda y \lambda x [\text{feed}'(y)(x) \wedge \text{dog}'(y)]$  (= C&L’s (12))

(6)  $\exists y [\text{feed}'(y)(j) \wedge \text{dog}'(y)]$  (= C&L’s (13))

(6) says that there is an individual  $y$  such that it is fed by John and it is a dog.

What is interesting about C&L’s analysis is that they try to seek morphosyntactic correlates of these two modes of semantic compositions. Thus, C&L (p. 154) state that “NPs, which denote properties, can be composed via Restrict” and further that “the domain of Specify is restricted to DPs and...the fact that NPs cannot compose in this mode is principled.” C&L discuss cases involving object incorporation in Chamorro to illustrate the correlation. I believe that C&L’s insight has significant consequences in anaphora as well, a topic to which we will turn in the next section.

### 3. Predicate Restriction in Reflexive Anaphora

There is nothing intrinsic about the approach developed by C&L (and also by van Geenhoven 1998 and Farkas and de Swart 2003) that it is limited to the semantics of indefinite NPs. In fact, I will argue that by extending C&L’s proposal to the domain of reflexive anaphora, we gain a better insight into the phenomena. The basic idea is that reflexive anaphors are interpreted in three different ways depending on the manner in which they compose with a predicate. First, the N head SELF might incorporate into the verb overtly or

---

<sup>1</sup> C&L’s analysis is couched in the Davidsonian event semantics, which I gloss over here for expository purposes.

<sup>2</sup> See Kratzer (1998) and Matthewson (1999) for different views of choice function.

<sup>3</sup> This is in contrast to van Geenhoven (1998) and Farkas and de Swart (2003), who assume that composition of a property-denoting expression with a predicate is basically saturating. See C&L (pp. 16-17) for discussion.

covertly (cf. R&R 1991, Safir 1996, Anagnostopoulou and Everaert 1999, Reuland 2001, this volume) and compose semantically with the predicate via the mode of Restrict, imposing an identity condition on the latter. Second, the DP as a whole might compose with a predicate via the mode of Specify. Third, the entire anaphor might be construed as an argument that enters into a chain with its antecedent (cf. R&R 1993, Reuland 2001).

### 3.1. The N-D Split Reflexivization

It has been pointed out by Pica (1987) and Keenan (1988) that complex anaphors in many languages are headed by a SELF morpheme, a relational expression of type  $\langle e, \langle e, t \rangle \rangle$ . Many researchers including R&R (1991), Safir (1996), Anagnostopoulou and Everaert (1999), and Reuland (2001, this volume) argue that the SELF morpheme undergoes head movement and incorporates into a verb, leaving behind a pronominal element. I adopt the head movement analysis of complex anaphors and propose that the syntactic operation of head movement is accompanied by the semantic composition via Restrict, whereby the incorporated item behaves as a predicate modifier and the composed predicate remains an expression of type  $\langle e, \langle e, t \rangle \rangle$ . Since the syntactic operation splits the DP argument into two parts, N and D, I call reflexivization in this configuration “N-D split reflexivization (= NDSR).”

(7) *N-D Split Reflexivization (NDSR)*

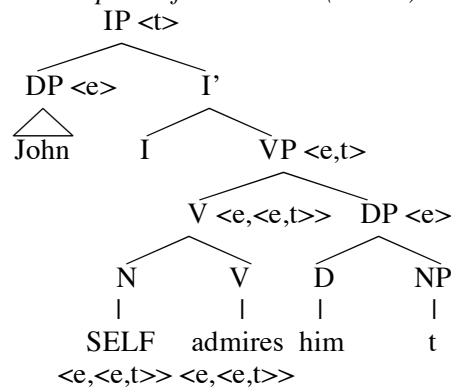

In this configuration, the reflexive morpheme and the pronominal remnant not only occupy distinct syntactic positions but behave as distinct semantic units as well—by behaving as a restrictive modifier in the case of the former and by behaving as an argument of the complex verb in the case of the latter. Since the pronoun saturates one of the argument positions of the composed predicate, the derivation completes without closing the formula by means of existential closure.

The N-D split configuration is not limited to the domain of reflexive anaphora. Consider object incorporation in Chamorro as discussed by C&L.



- (8) a. Hayi gāi-patgun? (= C&L's (1b))  
 who WH[nom].Agr.have-child  
 'Who has a child?'  
 b. Hayi gāi-patgun hao? (= C&L's (2b))  
 who WH[nom].Agr.have-child you  
 'Whose child are you (lit. Who has a child, namely, you)?'

C&L follow Mithun (1984) in analyzing this type of object incorporation as classificatory noun incorporation. A noun head is incorporated into a verb and acts as a restrictive (or classificatory) modifier. In (8b), there is a pronominal, or what C&L call "extra object," which saturates one of the argument positions of the composed predicate. Existential closure therefore does not apply in (8b), although it does in (8a).

### 3.2. SELF Incorporation at LF

The idea that the mode of composition Restrict is a fundamental operation that applies to reflexive anaphors is empirically supported. Notice that the composition of SELF with a predicate via Restrict is essentially a semantic operation and is independent of syntactic binding. This leads to the following prediction:

- (9) Reflexive anaphora is possible without coindexing.

That is, reflexivity can be independent of binding. Surprising though this claim may be, I will argue that the prediction is indeed borne out. I will draw some data from reflexive anaphora in Japanese to support the claim.

It is a well-known fact that personal pronouns in Japanese such as *kare* 'he' cannot be construed as bound variables (cf. Noguchi 1995, 1997 and references cited there).

- (10) \*Daremo<sub>i</sub>-ga kare<sub>i</sub>-no titioya-o sonkeisi-teiru.  
 everyone-NOM he-GEN father-ACC respect-PRES  
 'Everyone respects his father.'

The pronoun *kare* might combine with a SELF anaphor *zisin* 'self' to form a complex anaphor *kare-zisin* 'himself.' The complex anaphor cannot enter into variable binding, however, even though it can enter into coreference.

- (11) a. \*Daremo<sub>i</sub>-ga kare-zisin<sub>i</sub>-o sonkeisi-teiru.  
 everyone-NOM he-self-ACC respect-PRES  
 'Everyone respects himself.'  
 b. John<sub>i</sub>-ga kare-zisin<sub>i</sub>-o sonkeisi-teiru.  
 John-NOM he-self-ACC respect-PRES  
 'John respects himself.'

The contrast in (11) is significant: *kare-zisin* can be interpreted as a

coreferential pronoun but not as a bound variable. This follows from our proposal: *zisin* incorporates into the verb at LF and becomes a restrictive modifier of the latter, while the pronominal remnant saturates the argument position of the complex predicate.

- (12) a. John-ga [<sub>DP</sub> [<sub>NP</sub> [<sub>DP</sub> *kare*] [<sub>N</sub> *t<sub>i</sub>*]]]-o *zisin<sub>i</sub>*-sonkeisi-teiru.  
           <e>                                  <e>                                  <e,<e,t>>  
       b.  $\lambda y \lambda x$ [respect'(y)(x)  $\wedge$  y = x](him')(John')

The reason why *kare-zisin* is not construed as a bound variable is attributed to the fact that the pronoun *kare* cannot be construed as a bound variable.<sup>4</sup>

That anaphora involved in (11) is not binding but coreference is supported by the fact that a proper name can occur instead of a pronoun.

- (13) John<sub>i</sub>-ga John-zisin<sub>i</sub>-o sonkeisi-teiru.  
       John-NOM John-self-ACC respect-PRES  
       'John respects John himself.'

The same effect is observed in Malayalam as well (cf. Jayaseelan 1996).

- (14) a. \*raaman raaman-e weRuṭṭu. (= Jayaseelan's (24))  
       Raman Raman-ACC hated  
       'Raman hated Raman.'  
       b. raaman raaman-e t<sub>anne</sub> weRuṭṭu. (= Jayaseelan's (25))  
       Raman Raman-ACC self hated  
       'Raman hated Raman himself.'

It is possible for a proper name to be coreferential if the predicate is restricted by a reflexive morpheme as in (14b). Thus, the Japanese case cannot be dismissed as something idiosyncratic, but needs to be treated as a viable option allowed in UG.

Theoretically, the above result has an important implication for a theory of anaphora. Consider R&R's (1993) version of the Binding Theory, with (16) repeated from (1).

- (15) *Definitions* (= R&R's (40))  
       a. The *syntactic predicate* formed of (a head) P is P, all its syntactic arguments, and an external argument of P (subject). The *syntactic arguments* of P are the projections assigned  $\theta$ -role or Case by P.  
       b. The *semantic predicate* formed of P is P and all its arguments at the relevant semantic level.

---

<sup>4</sup> See Noguchi (1995, 1997), who argues that this follows from the N status of *kare*. The resulting configuration in (12a) thus illustrates an N-N split reflexivization rather than NDSR. The same remark applies to cases involving proper names we will see immediately.

- c. A predicate is *reflexive* iff two of its arguments are coindexed.
  - d. A predicate (formed of P) is *reflexive-marked* iff either P is lexically reflexive or one of P's arguments is a SELF anaphor.
- (16) *Conditions* (= R&R's (41))  
 A: A reflexive-marked syntactic predicate is reflexive.  
 B: A reflexive semantic predicate is reflexive-marked.

Note that in order for a predicate to be reflexive to satisfy Condition A, the predicate's arguments need to be *coindexed*. However, this is not what happens in Japanese and Malayalam, where the reflexive-marked predicate's arguments can be coreferential pronouns or proper names, those items that cannot be coindexed.<sup>5</sup> We are thus led to the following conclusion:

- (17) Reflexivity is independent of binding.

This is a natural result since reflexivity in our view is something that is ensured strictly by the semantic operation of predicate restriction.<sup>6</sup>

The above analysis in terms of SELF incorporation at LF is also supported by the fact that predicates in Japanese can be overtly SELF-marked.

- (18) John-ga [DP [NP [DP kare] [N t<sub>i</sub>]]]-o ziko<sub>i</sub>-hihan-si-ta.  
 John-NOM he-ACC self-criticism-do-PAST  
 'John criticized himself.'

Unlike the reflexive morpheme *zisin*, which incorporates into the verb at LF, the reflexive morpheme *ziko-* incorporates into the verb in the overt syntax.

- (19) *Ziko-* reflexivizes a predicate overtly, whereas *zisin* does so covertly.

That is, the reflexive morpheme is phonetically realized in two different positions in Japanese, i.e. either in N or as a prefix to a verb. But crucially, the predicate gets SELF-marked in either case by the time the derivation reaches LF, and a uniform treatment is available only if we assume (20).

- (20) Reflexivity is licensed by predicate restriction at LF.

When we turn to English, it is clear that the mode of Restrict is not of

---

<sup>5</sup> See Partee (1978), Bach and Partee (1980), Reinhart (1983), and Grodzinsky and Reinhart (1993) for related discussions.

<sup>6</sup> One might argue that the predicate with a proper name followed by a SELF morpheme in Japanese and Malayalam does not count as a *reflexive-marked* predicate (due to the definition in terms of "SELF anaphor") and that Condition A is not relevant. However, this misses an important generalization that covers both proper names and personal pronouns; as we saw in (13) and (11b), the behavior of *John-zisin* and *kare-zisin* is equivalent, and *kare-zisin* is clearly a SELF anaphor.

course limited to coreference.

- (21) a. Everyone<sub>i</sub> admires himself<sub>i</sub>.  
b. \*Everyone<sub>i</sub> admires him<sub>i</sub>.

(21b) is excluded by R&R's (1993) Condition B. (21a), on the other hand, undergoes NDSR.

- (22) [Everyone<sub>i</sub> [self<sub>j</sub>-admires [<sub>DP</sub> him<sub>i</sub> [<sub>NP</sub> t<sub>j</sub>]]]]

Here, *everyone* and the bound pronoun *him* saturate the argument positions of the complex predicate. Note that the predicate is reflexive-marked by SELF, satisfying Condition B. Thus, variable binding is also mediated through the mode of composition Restrict.

### 3.3. SELF Incorporation in the Lexicon

#### 3.3.1. Lexical Reflexives in Japanese

The claim that reflexivity does not have to be ensured by coindexed arguments is further confirmed by the following fact in Japanese. Japanese has another reflexive morpheme *zi-*, which lexically incorporates into a verbal-nominal or nominal stem of Chinese origin.<sup>7</sup>

- (23) a. Verbal-Nominal Stems:  
    *zi-ei* 'self-defense'      *zi-satu* 'suicide'  
    *zi-metu* 'self-destruction'    *zi-tyoo* 'self-mockery'  
b. Nominal Stems:  
    *zi-den* 'autobiography'      *zi-sya* 'one's own company'  
    *zi-isiki* 'self-awareness'    *zi-taku* 'one's own home'

The process of deriving these forms is hardly productive and thus bears the hallmarks of lexical derivation. As such, they might undergo further lexical processes such as derivation and compounding.

- (24) a. *ziei-tai* 'self-defense forces'    *ziga-zoo* 'self-portrait'  
    *zidoo-sya* 'automobile'      *zisyu-sei* 'self-reliance'  
b. *ziga zisan* 'self-praise'      *zikyuu zisoku* 'self-sufficiency'

Significantly, these items are in no way associated with coindexed arguments. Take *zi-ei tai* 'self-defense forces,' for example.

- (25) [<sub>N</sub> [<sub>V/N</sub> [<sub>N</sub> *zi*] [<sub>V/N</sub> *ei*]] [<sub>N</sub> *tai*]]

---

<sup>7</sup> The verbal-nominal stems need to be supported by the light verb *suru* 'do' to take arguments in a clause; with the nominal stems, this is not a possibility.

The predicate *ei* ‘defense’ is reflexive-marked in (25), but there is no way for it to be ‘reflexive’ in the sense of R&R (1993). Notice first that *tai* ‘forces’ is not an argument of the complex predicate *zi-ei* ‘self-defense’; the compound does not mean ‘forces that defend themselves,’ but rather ‘forces for people’s self-defense.’ Positing an empty pronoun within the compound does not help, given Postal’s (1969) observation that words are anaphoric islands. The only remaining possibility is to assume that an empty pronoun occupies a position outside the compound, say, [Spec, DP]. This again is not plausible, given that the expression does not have a place for such an argument to fill; thus, ‘self-defense forces’ is not semantically equivalent to ‘one’s self-defense forces.’ One is led to conclude that in a case like this, the predicate is reflexive-marked without having coindexed arguments, contra the prediction made by R&R (1993). Note that the lexical process of SELF incorporation discussed above is not accompanied by the semantic process of saturation; the mode of composition Restrict is thus independent of saturation (cf. C&L).

### 3.3.2. Lexical Reflexives in English

This analysis carries over to the analysis of *self*-compounds in English. Consider the following examples from Chomsky (1970):

- (26) a. John sent a self-addressed envelope.  
 b. John’s actions are self-destructive.

The NP *self-addressed envelope* is translated into the following formula:

$$(27) \lambda y \lambda z \exists x [\text{address}'(y)(z)(x) \wedge z = x \wedge \text{envelope}'(y)]$$

That is, the NP denotes the set of envelopes such that someone addresses those envelopes to himself. The SELF morpheme simply acts as a restrictive modifier that imposes an identity condition on the predicate.<sup>8</sup> Note that it does not denote the set of envelopes such that someone addresses those envelopes to themselves (= envelopes). Thus, there is again no way for the reflexive-marked predicate to be reflexive.

One might argue that these cases do not represent the regular compositional pattern that needs to be captured in any systematic way. It is true that there is something idiosyncratic about the way these cases are interpreted (cf. footnote 8), but this type of criticism leaves no room for an account of cases like the following, which certainly needs to be captured in a compositional manner:

---

<sup>8</sup> It is not entirely clear how to interpret the sentence in (26b), where the compound adjective *self-destructive* is predicated of the subject *John’s actions* and therefore the argument positions of *self* remain unsaturated.

(28) the city's self-destruction

One might argue that there is an empty pronoun in the complement position.

(29) [<sub>DP</sub> the city<sub>i</sub>]'s [<sub>NP</sub> self-destruction [<sub>DP</sub> pro<sub>i</sub>]]

Since the predicate is reflexive-marked and two of its arguments are coindexed, R&R's Condition A is satisfied. There is a problem for this solution, however: there is not much evidence to posit *pro* for a language like English, let alone evidence to license *pro* in a postnominal position as in (29). Under the current proposal, the SELF morpheme composes with the predicate via Restrict and acts as a restrictive modifier of the nominal *destruction*; the compound is translated into the following formula:

(30)  $\exists y \lambda x [\text{destruction}'(y)(x) \wedge y = x]$

In (28), the DP *the city* saturates the *x* argument, as desired.

To summarize, the behavior of SELF inside words poses a problem for an approach that tries to capture reflexivity in terms of syntactic binding. An alternative approach in terms of semantic composition is preferable on empirical grounds.

#### 4. Elsewhere in Reflexive Anaphora

The interpretation of a SELF anaphor in terms of the mode of composition Restrict captures the core cases of reflexive anaphora. It not only captures those cases involving the syntactic operation of head movement, i.e. those cases I call "NDSR," but also captures those cases involving lexical reflexives as long as the predicate is SELF-marked. This cannot be the whole story, however, and we now turn to the other cases in reflexive anaphora.

The basic idea I would like to pursue is the following. It is not always the case that the SELF morpheme of reflexive anaphors plays such an active role as in the case of NDSR. The entire anaphor, say, *himself*, may act as a syntactically inseparable unit, even if complex anaphors are morphologically complex and consist of two morphemes, i.e. a pronominal and SELF, two elements that are associated with distinct features, [+p] and [+a], respectively.<sup>9</sup> The proposal I would like to develop is summarized in (31).

(31) The features of complex anaphors [+p] and [+a] compete with each other. If [+p] wins out, the expression behaves as a pronominal; the SELF morpheme provides an argument structure instead. If [+a] wins out, the expression behaves as an anaphor; the SELF morpheme does not provide an argument structure.

---

<sup>9</sup> See Reuland (2001), who suggests that features like [+/-a] and [+/-p] can be derived from  $\Phi$ -feature composition.

- (32) a. him+self => [himself]<sub>[+p]</sub>    b. him+self => [himself]<sub>[+a]</sub>  
       [+p] [+a]                                    [+p] [+a]

The intuition behind this proposal is that language tries to make the fullest possible use of morphological resources available; thus, if one item provides an intrinsic feature like [+p], then the other item provides an argument structure, and vice versa. In what follows, I will argue that the [+a] case in (32b) represents reflexive anaphors in syntactic chains and that the [+p] case in (32a) represents those cases where a choice function applies to the complex anaphor as a whole. I will keep the discussion to the minimum due to space limitations, and focus on some of the basic cases to show an outline of the proposal.

#### 4.1. An Anaphor in A-Chain

A complex anaphor with a [+a] feature is an anaphoric element on a par with SE anaphors in many languages, and as such it occupies an argument position and forms an A-chain with its antecedent. This is the case which R&R (1993) try to capture in terms of the Chain Condition.<sup>10</sup>

- (33) *General condition on A-chains* (= R&R's (80))  
 A maximal A-chain ( $\alpha_1, \dots, \alpha_n$ ) contains exactly one link— $\alpha_1$ —that is both +R and Case-marked.

As R&R have shown, the contrast in Dutch in (34) follows because the A-chain is tailed by a [-R] element in (34a) but by a [+R] element in (34b). The ECM and raising cases in English in (35) are well-formed because the A-chain is tailed by a [-R] element.

- (34) a. Jan<sub>i</sub> hoorde [zich<sub>i</sub> zingen]. (= R&R's (84a))  
       Jan heard SE sing  
       b. \*Jan<sub>i</sub> hoorde [hem<sub>i</sub> zingen]. (= R&R's (84b))  
       Jan heard him sing  
 (35) a. John<sub>i</sub> believes [himself<sub>i</sub> to be smart].  
       b. John<sub>i</sub> seems to himself<sub>i</sub> [<sub>t<sub>i</sub></sub> to be smart].

Note that the SELF morpheme in (35) cannot undergo head movement and incorporate into the verb since the entire anaphor is not an argument of the predicate in the matrix clause; thus, the anaphor cannot semantically compose with the matrix predicate. In a language like Dutch where a SE-anaphor is available, this option is what is invoked as in (34a).

This is suggestive in that the Dutch anaphor is an expression of type e and is not associated with an argument structure. The English anaphor in (35) is

---

<sup>10</sup> See Reuland (2001), who elaborates on the status of chains in terms of checking chains. I will abstract away from this implementation.

represented in the following way in accordance with the proposal in (31):

(36) *A-chain Anaphor*

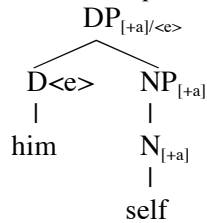

Since the DP is an argument of type *e*, it can create an A-chain (John, himself). This is a legitimate chain since the anaphor is associated with a [+a] feature.

Now, the question arises as to why the anaphor in (34a) and (35) must be locally related to another argument by being encoded in an A-chain. Reuland (2001) derives the locality effect from an interpretive condition.

(37) *Rule BV: Bound variable representation* (= Reuland's (50))

NP A cannot be A-bound by NP B if replacing A with C, C an NP such that B heads an A-CHAIN tailed by C, yields an indistinguishable interface representation.

This in effect puts a heavier restriction on variable binding and coreference in favor of relating two expressions in a syntactic chain. Reuland argues that (37) does not have to be stipulated as such, but follows from general properties of the language design. If we adopt this proposal, then the locality effect of Condition A can be reduced to an independently motivated condition on syntactic chain formation.

## 4.2. Choice-Function Anaphors

The other way of looking at the complex anaphor in English is to use the intrinsic feature of the pronoun and the argument structure of SELF.

(38) *Choice-function Anaphor*

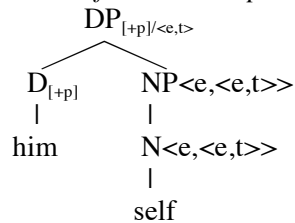

Semantically speaking, the determiner head denotes an entity of type *e* and the reflexive morpheme a two-place relation of type  $\langle e, \langle e, t \rangle \rangle$ . The determiner saturates one of the argument positions of the predicate, with the



result that the entire expression becomes a one-place predicate and denotes a set of individuals. Recall Reinhart's (1997) definition of choice function in (3), repeated here as (39).

- (39) A function  $f$  is a choice function (CH ( $f$ )) if it applies to any non-empty set and yields a member of that set.

Since the DP as represented in (38) denotes a set of individuals, a choice function can apply to it and the DP composes with a predicate via Specify. The question is: is this option realized? I argue that it is. I will discuss two cases, although the second will be postponed until 4.3. Here, I would like to suggest in a tentative manner that the complex anaphor in question is what is involved in the logophoric use of reflexive pronouns.

As Clements (1975: 141) states, a language might employ a particular series of pronouns "to distinguish reference to the individual whose speech, thoughts, or feelings are reported or reflected in a given linguistic context." I suggest that the logophoric use of reflexive pronouns indicates that their reference is determined by way of a choice function. It is revealing to note that Kratzer (1998: 167) characterizes choice functions as "contextually determined, often intended by the speaker, but not revealed to the audience." This characterization, I suggest, applies to logophoricity as well. Thus, I take logophoricity to be a type of specificity that arises from the use of pronouns as function variables.

Recall Reinhart's (1997) and Winter's (1997) claim that existential closure of choice function variables occurs at any compositional level. This accounts for the three-way scope ambiguity in a sentence (40).

- (40) Most linguists have looked at every analysis that solves some problem.  
(= Reinhart's (21a))

Here, the indefinite *some problem* takes widest scope, intermediate scope, or narrow scope with respect to the quantified expressions *most linguists* and *every analysis*. The ambiguity arises as to the level at which the choice function variable is bound by an existential operator (cf. Matthewson 1999).

- (41) a.  $\exists f[\text{for most linguists}'(x), \forall y[(\text{analysis}'(y) \wedge \text{solve}'(f(\text{problem}'))(y)) \rightarrow \text{looked-at}'(y)(x)]]$   
 b.  $\text{For most linguists}'(x), \exists f[\forall y[(\text{analysis}'(y) \wedge \text{solve}'(f(\text{problem}'))(y)) \rightarrow \text{looked-at}'(y)(x)]]$   
 c.  $\text{For most linguists}'(x), \forall y[(\text{analysis}'(y) \wedge \exists f[\text{solve}'(f(\text{problem}'))(y)]] \rightarrow \text{looked-at}'(y)(x)]$

I suggest that the situation is parallel in the case of the logophoric use of reflexive pronouns.

- (42) a. He<sub>i</sub> sat down at the desk and opened the drawers. In the top right-hand one was an envelope addressed to himself<sub>i</sub>. (Zribi-Hertz 1989: 716)  
 b. I told Albert that physicists like himself were a godsend. (Ross

1970: 230)

- c. John thought that Mary liked a picture of herself.

The reference of the reflexive pronoun in (42a) is established extra-sententially, while the pronoun in (42b) has its antecedent in the matrix clause. (42c) represents the usual case in which the pronoun takes its antecedent in the same clause. If, as Kratzer (1998) suggests, the referential use of indefinites (cf. Fodor and Sag 1982) can be captured through a choice function, then the reference of reflexive pronouns can be established by a choice function as well. Thus, those cases in (42) differ only as to the level at which existential closure of a choice function applies, i.e. at the highest level in (42a), intermediate level in (42b), and lowest level in (42c).<sup>11</sup>

I cannot do justice to the wealth of knowledge reported in the literature, however, and the discussion of logophoricity must remain programmatic. Especially, the problem needs to be addressed concerning a variety of opacity factors (syntactic, semantic, and pragmatic) and crosslinguistic variations involved. But a much longer paper would be needed to address that issue.

### 4.3. Reflexive Anaphors in Ellipsis

Let us return to ECM and raising cases in (35), repeated here as (43).

- (43) a. John<sub>i</sub> believes [himself<sub>i</sub> to be smart].  
b. John<sub>i</sub> seems to himself<sub>i</sub> [t<sub>i</sub> to be smart].

In 4.1, we saw that the reflexive anaphor might suppress the [+p] feature and enter into an A-chain. The other possibility, i.e. suppressing the [+a] feature, is prohibited from entering into an A-chain since such an A-chain would be tailed by a pronominal, i.e. an element with a [+R] feature. Or in Reuland's (2001) system, this option is blocked because the cheaper option of relating two expressions in a syntactic chain is available. This possibility would be equivalent to the following examples:

- (44) a. \*John<sub>i</sub> believes [him<sub>i</sub> to be smart].  
b. \*John<sub>i</sub> seems to him<sub>i</sub> [t<sub>i</sub> to be smart].

However, with an anaphor associated with a [+p] feature, forming an A-chain with its antecedent is not the only possibility. Since such an anaphor would denote a property, we might expect it to be interpreted in terms of a choice function and to establish its own reference. Thus, the anaphor in (43) should be interpreted in two ways in principle—by means of an A-chain or a choice function, but only if the latter option contributes to a distinguishable interface representation.

---

<sup>11</sup> Note that this particular implementation is not allowed in Kratzer's (1998) system, in which the value of choice function variables is only provided by the context.

I believe that this is precisely what accounts for the ambiguity in VP ellipsis cases like the following (cf. Sag 1976, Kitagawa 1991):

- (45) John considers himself to be smart, and Bill does too.  
a. Bill does [<sub>VP</sub> consider himself<sub>[+a]/<e></sub> to be smart]. (Sloppy reading)  
b. Bill does [<sub>VP</sub> consider himself<sub>[+p]/<e,t></sub> to be smart]. (Strict reading)

In (45a), the anaphor retains the [+a] feature and as such forms an A-chain with its antecedent. In (45b), however, the anaphor retains the [+p] feature and carries over its reference from the first conjunct, giving rise to the strict identity reading.

One might wonder what accounts for the difference in grammaticality between (43) and (44), given that the reflexive anaphor in (43) can be associated with a [+p] feature. What is crucial here is the role played by the SELF morpheme of the complex anaphor, which, as we have seen, provides an argument structure for the DP. Thus, the entire DP behaves as a one-place predicate and is interpreted by way of a choice function, dissociating itself from an A-chain and establishing its own reference, and hence circumventing Rule BV. This is not a possibility with the personal pronoun *him*, which denotes an entity of type *e*. Note that Condition B is not relevant, since, as R&R (1993) have shown, it only applies to a semantic predicate. Thus, both (45a) and (45b) are available as well-formed representations.

Note that a similar effect can be observed in coargument cases like the following discussed by Fiengo and May (1994):

- (46) Bush voted for himself, and Laura did too.

Although the mismatch in  $\phi$ -features makes the pronominal use of an anaphor a favorable option, this is not the whole story. Consider the following example (cf. Sells, Zaenen, and Zec 1987, Hestvik 1992):

- (47) John defended himself better than Bill did. (= Hestvik's (3b))

This example is ambiguous and allows both the sloppy identity and the strict identity reading at the VP ellipsis site. Compare this example with the following, which is not ambiguous:

- (48) John's self-defense is better than Peter's.

Since the predicate is overtly SELF-marked, the SELF morpheme can only act as a restrictive modifier and imposes an identity condition on the predicate; thus, only the sloppy reading is possible at the ellipsis site. The reason why (47) can be interpreted ambiguously is that the entire anaphor can be associated with a [+a] or [+p] feature. The latter option, however, is made possible by the use of a choice function, which, as we saw, can be influenced by pragmatic factors. This is why the sloppy identity is the default option under normal circumstances.

Hestvik (1992) argues that the fact that a strict identity reading is available in (47) should be explained in syntactic terms. The representation for (47) would be roughly the following:

(49) [John [himself<sub>i</sub> T [<sub>VP</sub> [<sub>VP</sub> defended t<sub>i</sub>] better than Bill did [<sub>VP</sub> defended t<sub>i</sub>]]]]

Here, the reflexive pronoun as a whole undergoes movement at LF, whose landing site need not concern us here. Note that the reflexive c-commands both the original trace and the trace inside the VP copy. Since the reflexive pronoun itself is bound by the subject *John*, the strict reading arises. What is crucial for Hestvik is that the comparative clause is subordinated to the matrix clause, enabling the reflexive pronoun to c-command the trace inside the VP copy. Hestvik argues that this is why a strict identity reading is not readily available in coordination cases like the following:

(50) John defended himself well, and Bill did too. (= Hestvik's (3a))

However, we already saw that even in a coordination case like (46), the strict reading is available or even preferred. Clearly, pragmatic factors influence the readings. In this respect, the strict identity reading in VP ellipsis has a lot in common with the logophoric use of reflexives: they are both governed by the lexical choice and pragmatic factors. Under the current proposal, this is quite natural since the pronominal use of a complex reflexive determines its reference through the context-sensitive choice function.

## 5. Some Consequences

The proposal I have developed so far is that reflexive anaphors are interpreted in three different ways, i.e. by means of (i) a predicate restriction based on SELF incorporation (NDSR), (ii) a choice function applying to the entire DP denoting a set of individuals, and (iii) an A-chain formation. Each of the mechanisms invoked here is independently motivated. C&L show that the behavior of two indefinite articles in Maori, *he* and *tētahi*, is captured in terms of the two modes of composition Restrict and Specify. Reuland (2001) has shown rather persuasively that a generalized version of syntactic chain formation can be derived from the fundamental properties of  $C_{HL}$ .

The above consideration naturally leads us to look for phenomena other than reflexive anaphora that might fall under the same scheme. In this section, I will discuss phenomena involving bare nominals, control, and body-part nominals to provide some independent empirical motivation for the basic approach I have taken.

First, consider the following examples involving a bare nominal *hostility*:

- (51) a. John showed hostility.  
 b. John showed hostility to be immoral.

In (51a), hostility is attributed to John, whereas in (51b), there is no such relation between the subject and the bare nominal: (51a) is like obligatory control, whereas (51b) like optional control.<sup>12</sup>

This discrepancy in interpretation of the bare nominal falls under the present account. Suppose first that the bare nominal *hostility* is a relational noun of type  $\langle e, \langle e, t \rangle \rangle$ : one can be hostile to another. The bare nominal in the object position incorporates into the predicate at LF and composes with it via the mode of Restrict. Unlike the SELF morpheme, the bare nominal does not impose an identity condition on the predicate, although it acts as a predicate modifier. Suppose that the external argument of the nominal is  $\theta$ -identified by one of the verb's arguments by being linked to it (cf. Higginbotham 1985).

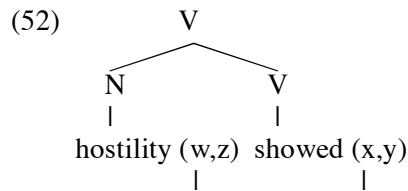

The apparent obligatory control effect obtains as a result of  $\theta$ -identification. It is quite natural to assume that  $\theta$ -identification is limited to a local morphosyntactic domain and therefore that it does not apply to the ECM subject case like (51b). The external argument of the bare nominal in (51b) cannot therefore be saturated by any of the arguments of the matrix verb.

A similar remark can be made about gerunds and infinitives.<sup>13</sup>

- (53) a. We considered going abroad.  
 b. We considered going abroad to be important.
- (54) a. I don't want to flagellate myself in public.  
 b. I don't want to flagellate oneself in public becomes standard practice in this monastery. (Aoun and Lightfoot 1984: 466)

---

<sup>12</sup> This observation is due to Kinsuke Hasegawa in his class lectures at the University of Tokyo in the late 1980's. Examples in (51) are variations of those discussed by Wasow (1977: 332), albeit in a different context. Ivan Sag (personal communication) points out that the following example exhibits obligatory control effect as well:

- (i) John's activity showed hostility.

The current proposal predicts that anaphora in this case is established in a different manner from that in (51a), but the question of exactly how needs to remain open.

<sup>13</sup> Examples in (53) are due to Yuki Ishihara (personal communication), who points out that the work by Ross (1972: 74-76) contains a discussion that hints at the distinction.

One needs to be careful in extending the current proposal to these cases, however, since it is not likely that the syntactic operation of head movement is at work in (53a) and (54a). But if we assume with Chierchia (1984, 1989) that obligatory control complements denote properties rather than propositions, then the complement and the verb directly compose via the mode of Restrict. This option is not available with the ECM subject in (53b) and (54b).

Finally, consider the behavior of body-part nominals (cf. Safir 1996).

(55) a. John opened his eyes.    b. Mary batted her/\*his eyes.

Body-part nominals like *eyes* are typical relational expressions and their behavior is similar to that of bare nominals we observed above. Thus, the nominal in (55a) undergoes head movement, creating a configuration similar to NDSR.

(56) John eyes<sub>i</sub>-opened [<sub>DP</sub> his [<sub>NP</sub> t<sub>i</sub>]]

Here, the possessive pronoun does not play an active role in interpretation and might be considered an expletive. The body-part nominal acts as a restrictive modifier of the verb, with its possessor argument being  $\theta$ -identified with the external argument of the verb. Another way of interpreting the body-part nominal in (55a) is to interpret it in situ. If this option is taken, the possessor plays an active role because the body-part nominal is not in a configuration where its external argument is  $\theta$ -identified by an argument of the verb, hence the interpretation ‘John opened someone else’s eyes.’ This option is subject to pragmatic conditions, however. It is not pragmatically incoherent that someone opens someone else’s eyes as when an ophthalmologist examines his patient, but the situation is rather different in (55b): one can only bat one’s own eyes, but not someone else’s, hence the lack of ambiguity in (55b).

This now leads to the following prediction: if the body-part nominal in question can be interpreted in a pragmatically coherent situation, then it does not have to be in a complement of the verb. As Safir (1995) shows, this prediction is borne out.

(57) a. Mary expected her eyes to be opened.  
       b. \*Mary expected her eyes to be batted.

The contrast is due to the fact that the possessor can play an active role in (57a) and establish its own reference in the domain of discourse, while this option is not available in (57b).

## 6. Conclusion

The semantic mechanism proposed by C&L for indefinite NPs turns out to

have a wider application than suggested and a wider range of anaphora facts now falls into place, without resorting to Condition A. To the extent that the present approach is successful, Condition A has been factored out into independently motivated semantic and syntactic conditions and can therefore be eliminated from the grammar. This is a welcome result in view of the general nature of the mechanisms involved.

## References

- Anagnostopoulou, E. and M. Everaert (1999) "Toward a More Complete Typology of Anaphoric Expressions." *Linguistic Inquiry* 30: 97-119.
- Aoun, J. and D. W. Lightfoot (1984) "Government and Contraction." *Linguistic Inquiry* 15: 465-473.
- Bach, E. and B. H. Partee (1980) "Anaphora and Semantic Structure." In *Papers from the Parasession on Pronouns and Anaphora*, 1-28. Chicago Linguistic Society, University of Chicago.
- Chierchia, G. (1984) *Topics in the Syntax and Semantics of Infinitives and Gerunds*. Ph.D. Dissertation, University of Massachusetts, Amherst.
- Chierchia, G. (1989) "Anaphora and Attitudes De Se." In R. Bartsch, J. van Benthem, and P. van Emde Boas (eds.) *Semantics and Contextual Expression*, 1-31. Dordrecht: Foris.
- Chomsky, N. (1970) "Remarks on Nominalization." In R. A. Jacobs and P. S. Rosenbaum (eds.) *Readings in English Transformational Grammar*, 184-221. Waltham, MA: Ginn and Co.
- Chomsky, N. (1981) *Lectures on Government and Binding*. Dordrecht: Foris.
- Chung, S. and W. A. Ladusaw (2004) *Restriction and Saturation*. Cambridge, MA: MIT Press.
- Clements, G. N. (1975) "The Logophoric Pronoun in Ewe: Its Role in Discourse." *Journal of West African Languages* 2: 141-177.
- Farkas, D. F. and H. de Swart (2003) *The Semantics of Incorporation: From Argument Structure to Discourse Transparency*. Stanford, CA: CSLI.
- Fiengo, R. and R. May (1994) *Indices and Identity*. Cambridge, MA: MIT Press.
- Fodor, J. D. and I. Sag (1982) "Referential and Quantificational Indefinites." *Linguistics and Philosophy* 5: 355-398.
- Grodzinsky, Y. and T. Reinhart (1993) "The Innateness of Binding and Coreference." *Linguistic Inquiry* 24: 69-101.
- Heim, I. (1982) *The Semantics of Definite and Indefinite Noun Phrases*. Ph.D. Dissertation, University of Massachusetts, Amherst.
- Hestvik, A. (1992) "Strict Reflexives and the Subordination Effect." *Proceedings of the Stuttgart Ellipsis Workshop*, University of Stuttgart.
- Higginbotham, J. (1985) "On Semantics." *Linguistic Inquiry* 16: 547-593.
- Jayaseelan, K. A. (1996) "Anaphors as Pronouns." *Studia Linguistica* 50: 207-255.
- Kamp, H. (1981) "A Theory of Truth and Semantic Representation." In J. Groenendijk, T. Janssen, and M. Stokhof (eds.) *Truth, Interpretation, and Information*, 1-41. Dordrecht: Foris.
- Keenan, E. L. (1988) "On Semantics and the Binding Theory." In J. A. Hawkins (ed.) *Explaining Language Universals*, 105-144. Oxford: Basil Blackwell.
- Kitagawa, Y. (1991) "Copying Identity." *Natural Language and Linguistic Theory* 9: 497-536.
- Kratzer, A. (1998) "Scope or Pseudoscope? Are There Wide-Scope Indefinites?" In S. Rothstein (ed.) *Events and Grammar*, 163-196.

- Dordrecht: Kluwer.
- Matthewson, L. (1999) "On the Interpretation of Wide-Scope Indefinites." *Natural Language Semantics* 7: 79-134.
- Mithun, M. (1984) "The Evolution of Noun Incorporation." *Language* 60: 847-894.
- Noguchi, T. (1995) *The Role of Syntactic Categories in Anaphora*. Ph.D. Dissertation, University of Massachusetts, Amherst.
- Noguchi, T. (1997) "Two Types of Pronouns and Variable Binding." *Language* 73: 770-797.
- Partee, B. H. (1978) "Bound Variables and Other Anaphors." In *Theoretical Issues in Natural Language Processing 2*, 79-85. University of Illinois, Urbana.
- Partee, B. H. (1986) "Noun Phrase Interpretation and Typo-Shifting Principles." In J. Groenendijk, D. de Jong, and M. Stokhof (eds.) *Studies in Discourse Representation Theory and the Theory of Generalized Quantifiers*, 115-143. Dordrecht: Foris.
- Pica, P. (1987) "On the Nature of Reflexivization Cycle." *Proceedings of NELS 17*: 483-499.
- Postal, P. (1969) "Anaphoric Islands." *Proceedings of CLS 5*: 205-239.
- Reinhart, T. (1983) *Anaphora and Semantic Interpretation*. London: Croom Helm.
- Reinhart, T. (1997) "Quantifier Scope: How Labor Is Divided between QR and Choice Functions." *Linguistics and Philosophy* 20: 335-397.
- Reinhart, T. and E. Reuland (1991) "Anaphors and Logophors: An Argument Structure Perspective." In by J. Koster and E. Reuland (eds.) *Long-Distance Anaphora*, 283-321. Cambridge: Cambridge University Press.
- Reinhart, T. and E. Reuland (1993) "Reflexivity." *Linguistic Inquiry* 24: 657-720.
- Reuland, E. (2001) "Primitives of Binding." *Linguistic Inquiry* 32: 439-492.
- Reuland, E. (this volume) "Binding Conditions: How Are They Derived?"
- Ross, J. R. (1970) "On Declarative Sentences." In R. A. Jacobs and P. S. Rosenbaum (eds.) *Readings in English Transformational Grammar*, 222-272. Waltham, MA: Ginn and Co.
- Ross, J. R. (1972) "Doubl-ing." *Linguistic Inquiry* 3: 61-86.
- Safir, K. (1995) "Abstract Incorporation vs. Abstract Cliticization." *Proceedings of CLS 31.2: The Parasession of Clitics*: 280-299.
- Safir, K. (1996) "Semantic Atoms of Anaphora." *Natural Language and Linguistic Theory* 14: 545-589.
- Sag, I. A. (1976) *Deletion and Logical Form*. Ph.D. Dissertation, MIT.
- Sells, P., A. Zaenen, and D. Zec (1987) "Reflexivization Variation: Relations between Syntax, Semantics, and Lexical Structure." In M. Iida, S. Wechsler, and D. Zec (eds.) *Working Papers in Grammatical Theory and Discourse Structure: Interactions of Morphology, Syntax, and Discourse*, 169-238. Stanford, CA: CSLI.
- Van Geenhoven, V. (1998) *Semantic Incorporation and Indefinite Descriptions: Semantic and Syntactic Aspects of Noun Incorporation in West Greenlandic*. Stanford, CA: CSLI.
- Wasow, T. (1977) "Transformations and the Lexicon." In P. W. Culicover, T. Wasow, and A. Akmajian (eds.) *Formal Syntax*, 327-360. New York: Academic Press.
- Winter, Y. (1997) "Choice Functions and the Scopal Semantics of Indefinites." *Linguistics and Philosophy* 20: 399-467.
- Zribi-Hertz, A. (1989) "Anaphor Binding and Narrative Point of View: English Reflexive Pronouns in Sentence and Discourse." *Language* 65: 695-727.



# Remarks on Binding Theory

Carl Pollard

Ohio State University

Proceedings of the 12th International Conference on  
Head-Driven Phrase Structure Grammar

Department of Informatics, University of Lisbon

Stefan Müller (Editor)

2005

Stanford, CA: CSLI Publications

pages 561–577

Pollard, Carl. 2005. Remarks on Binding Theory. In Stefan Müller (ed.), *Proceedings of the 12th International Conference on Head-Driven Phrase Structure Grammar, Department of Informatics, University of Lisbon*, 561–577. Stanford, CA: CSLI Publications. DOI: 10.21248/hpsg.2005.32.



## Abstract

We propose some reformulations of binding principle A that build on recent work by Pollard and Xue, and by Runner et al. We then turn to the thorny issue of the status of indices, in connection with the seemingly simpler Principle B. We conclude that the notion of index is fundamentally incoherent, and suggest some possible approaches to eliminating them as theoretical primitives. One possibility is to let logical variables take up the explanatory burden borne by indices, but this turns out to be fraught with difficulties. Another approach, which involves returning to the idea that referentially dependent expressions denote identity functions (as proposed, independently, by Pollard and Sag and by Jacobson) seems to hold more promise.

## 1 Introduction

As formulated by Chomsky (1986), binding theory (hereafter BT) constrained **indexings**, which were taken to be assignments of **indices** to the NPs in a phrase. What an index was was irrelevant; what mattered was that they partitioned all the NPs in a phrase into equivalence classes. Phrases, in turn, were taken to be trees of the familiar kind and the binding constraints themselves were couched in terms of tree-configurational notions such as **government**, **c-command** (or **m-command**), **chain**, and **maximal projection**. In the early 1990's, numerous studies (Everaert, 1991; Hellan, 1991; Pollard and Sag, 1992; Pollard and Sag, 1994; Reinhart and Reuland, 1991; Reinhart and Reuland, 1993) converged on the view that a wide range of facts at odds with Chomsky's BT became explicable if the binding constraints were reformulated in terms of the argument structures of the predicates rather than tree configurations. Additionally, many of these same investigators and others (Sells, 1987; Zribi-Hertz, 1989; Baker, 1995; Pollard and Xue, 1998; Pollard and Xue, 2001; Golde, 1999; Runner et al., 2002) recognized that a distinction had to be drawn between (1) occurrences of referentially dependent elements subject to syntactically characterizable constraints on their (linguistic) antecedents, and (2) occurrences subject to interpretive constraints couched in terms of such discorsal/information-structural notions as logophoricity, discourse prominence, and contrastiveness.<sup>1</sup> Following a common usage, we will limit the term "BT" to constraints of the first kind, and speak of occurrences of referentially dependent expressions which are subject only to the second kind of constraint as **exempt** from BT.

---

<sup>†</sup>For helpful discussion, I would like to thank the participants in the Lisbon Binding Theory Workshop, especially Yusuke Kubota, Jeff Runner, and Ping Xue. The research reported here was supported by a grant from the National Science Foundation.

<sup>1</sup>It is often assumed that there is lexical ambiguity between the first type and the second, but another possibility is that expressions which have been analyzed in this way are not ambiguous, but rather are subject to syntactic constraints in some environments and to discorsal/information-structural ones in other environments. See Pollard and Xue 1998 and 2001 for discussion.

The following remarks are organized as follows. In section 2, we review a (somewhat dated) HPSG-based formulation of Principles A and B (Pollard and Sag 1992, 1994), which we will use as a point of departure. Section 3 examines two recent but mutually inconsistent refinements of Principle A and seeks a synthesis to resolve the inconsistency. In section 4, we turn to Principle B, which is usually considered simpler than Principle A since there are not the troublesome notions of reflexivity (or reciprocity) and exemption to contend with. But, we will argue, the simplicity is illusory, because it is with Principle B that we are forced to confront in its purest form the even more vexing question of just what exactly it is that BT constrains. Section 5 draws some tentative conclusions and suggests some directions for future investigation.

## 2 Pollard and Sag’s Reformulation of Principles A and B

### 2.1 HPSG Background

Pollard and Sag’s reformulations of Chomsky’s (1986) first two BT principles are couched not in tree-configurational terms but rather in terms of **valence**, which is a certain technical embodiment of the notion of syntactic argument structure. Words are assumed to select their subjects, specifiers, and complements via **valence features** (SUBJ, SPR<sup>2</sup>, and COMPS respectively). This applies not only to verbs (including auxiliaries) but also to other argument-taking words, such as nouns with possessive determiners or PP complements, and predicative adjectives and prepositions, including the lexical heads of absolutive sentential modifiers and so-called “reduced relatives” (postnominal predicative modifiers).

Except for dummy *it* and *there*, NPs and “case-marked” PPs (ones with semantically vacuous prepositions) in English are assumed to have an **index**. These include not just phonetically realized elements, but also the HPSG analogs of inaudible elements such as PRO (e.g. unexpressed subjects of VP complements) and syntactic variables (gaps in unbounded dependencies).<sup>3</sup>

Every indexed element belongs to one of the three **reference types: r-pronoun, p-pronoun, or non-pronoun**. R-pronouns include overt reflexives and reciprocal *each other*; p-pronouns include ordinary nonreflexive definite pronouns; and all other overt indexed NPs, including names, relative and interrogative “pronouns”, and other NPs headed by common nouns, are non-pronouns. Some standard analytic assumptions are the following: (1) Any case-marked PP has the same reference type and the same index as the object of the preposition; (2) in an unbounded dependency, the trace has the same reference type and the same index as the filler; and (3) in raising (to subject or object), the unrealized complement subject has the same reference type and the same index as the controller.

<sup>2</sup>The notion of specifier employed here is different from the GB notion of the same name. Here determiners (including possessive ones) are analyzed as specifiers of nouns and comparative gradables, and degree phrases as specifiers of noncomparative gradables; but subjects are distinct from specifiers, and fillers (“extracted” phrases) are not analyzed as valents at all.

<sup>3</sup>For present purposes, we will speak as if gaps are analyzed as phonetically null constituents (traces), but nothing hinges on this.

The valents of a word have an abstract linear order (possibly different from the temporal order of their phonetic realizations) called the **obliqueness** order. The centrally important notion of **local o-command** is defined in terms of the obliqueness order as in (1):

(1) Local o-command

For  $X$  and  $Y$  two indexed valents (subjects, specifiers, or complements) of a word,  $X$  **locally o-commands**  $Y$  just in case it precedes  $Y$  in the obliqueness order of that word's valents.

At least for English, the following analytic assumptions have been standard. First, indexed subjects and specifiers locally o-command indexed complements; in particular, a possessive determiner of a noun locally o-commands a nonpredicative PP complement of the noun, as in so-called "picture NPs" (PNPs) such as *Mary's picture of herself*. And second, if both subject and specifier are present (e.g. *Mary considers John her ally*), the subject (here, *John*) locally o-commands the specifier (here, *her*).

Pollard and Sag's reformulations of Principles A and B then run as follows:

(2) Binding Theory for English (Pollard and Sag 1992, 1994)

- a. Principle A: Every locally o-commanded r-pronoun is coindexed with one of its local o-commanders.
- b. Principle B: Every p-pronoun is coindexed with none of its local o-commanders.

It is important to note that r-pronouns which are *not* locally o-commanded are *not* required by this formulation of BT to be coindexed with anything else; though their interpretation *is* assumed to be subject to other, nonsyntactic, constraints of a discursal or information-structural nature. Such r-pronouns are said to be **BT-exempt**, or simply **exempt**.

Some exempt positions for r-pronouns are listed in (3):

(3) Some Exempt positions for r-pronouns

- a. subjects of nonfinite ("small") clauses
- b. objects of verbs with dummy *it* subjects
- c. (possessive) determiners of nonpredicative NPs
- d. PP complements of nonpredicative NPs without possessive determiners.

By comparison, Chomsky's (1986) form of Principle A wrongly requires such r-pronouns ("anaphors" in his terminology) to be "A-bound" i.e. coindexed with a c-commanding NP in an argument position within a certain "governing category" (specifically, the least maximal projection containing a subject, the r-pronoun, and the r-pronoun's governor). For a nonexhaustive list of kinds of examples where the Pollard-Sag account compares favorably with Chomsky's, see Pollard and Sag 1994, p. 245.

In spite of the many technical and empirical differences between the Pollard-Sag BT and Chomsky's (see Pollard and Sag 1992 and 1994 for extensive discussion), there are also many striking similarities, including the following. First, in a candidate structure being considered with respect to BT-compatibility, each nondummy NP has associated with it something called its index. Second, the structures contain substructures (either subtrees or sub-feature-structures) corresponding not just to overt NPs but also to controllers (PRO, null pronouns (pro), gaps (*variables* in the GB sense), and raised NPs (NP-trace). Third, overt controllers, "raised" constituents, and "wh-moved" constituents (fillers in HPSG, non-null heads of  $\bar{A}$ -chains in GB) are coindexed with the corresponding "abstract" elements (PRO, pro, variable, or NP-trace in GB; a member of the list value of some valence feature in HPSG<sup>4</sup>). Fourth, in cases where a quantified NP (hereafter, QNP) semantically binds a pronoun or reflexive (in the sense that in a standard logical translation, the logical determiner of the QNP logically binds two logical variable instances, one from the QNP itself and one from the pronoun/reflexive), the QNP and the pronoun/reflexive are coindexed; and this holds true even if the QNP does not o-command/c-command the pronoun/reflexive, as in examples such as the following:

- (4) a. The first dollar he ever earned is the most treasured possession of many a successful entrepreneur.  
 b. Some crank in every little midwestern would like to burn it to the ground.

Fifth, coreference need not occasion coindexing, as illustrated in the following examples:

- (5) a. He's the man that shot Liberty Valance. [speaker pointing at Black Bart]  
 b. While he was suffering from amnesia, Nixon didn't realize that he was actually Richard Nixon.

Sixth, by virtue of Principle A, some r-pronoun/anaphor occurrences (exactly which ones depending on the theory) are required to bear *the same* index as certain other NPs. And seventh, certain pronoun/pronominal occurrences (again, exactly which ones depending on the theory) are required to bear indices which are *distinct* from those of certain other NPs.

It is striking that two theories formulated within frameworks that differ so dramatically in terms of their methodological assumptions and theoretical primitives should agree on so much. So striking, in fact, that one might well suspect they are two theories about the same things, things which both theories call **indices**. But what are these indices that the two BTs seem to bear about? In the following subsection, we review what HPSG says about this, but we will return to this question from a less theory-bound perspective in section 4.

## 2.2 Indices in HPSG

On the Pollard-Sag account, indices are not just integers (or other unique identifiers) assigned to NP nodes in trees as they are in GB. Rather, for each nondummy

<sup>4</sup>Or, in recent HPSG, a member of the list value of the ARGSTRUC feature.

NP (or case-marked PP), irrespective of its feature-structure type (*sign*, *synsem*, or *local*), there is a feature path terminating with *CONTENT|RESTIND|INDEX* leading to a substructure of type *index*, which in turn bears a set of features usually called *agreement* features (usually, *PERSON*, *NUMBER*, *GENDER*). This is the case no matter whether the index-bearing element is a QNP (e.g. *every boy*), a name (e.g. *Kim*), a pronoun/reflexive, or one of the “abstract” *ARGSTRUC* elements that does not correspond directly to a realized *sign*.

Let us consider some of the cases. (1) In the case of a QNP, the index occurs in the feature-structural representation of the logical quantifier in the position corresponding to that of the first  $x$  in  $\forall x(\text{boy}'(x))$  in a restricted-quantification logical representation. (2) For a name, the index is playing a role in the *CONTENT* value essentially like the one that would be played by a logical constant (say, in a translation into intensional logic). (3) For a bound pronoun, reflexive, *pro*, *PRO*, or trace, the index is playing a role analogous to the one that would be played by an occurrence of a logical variable in an argument position of a predicate in a logical translation. (4) And for a deictic or logophoric pronoun, the index is playing a role analogous to that of a logical parameter/indeterminate (i.e. a free variable whose reference is fixed by the utterance context). What is problematic here is that in the kind of semantics that 1990's-style HPSG *CONTENT* values are supposed to be modelling (i.e. west-coast-style situation semantics), there no one kind of thing that corresponds to all these different kinds of occurrences of indices.

Now it might be argued that none of this matters because scarcely anybody actually does situation semantics anymore anyway; even in the HPSG community, the Pollard-Sag situation-semantics-inspired *CONTENT* values have mostly been superseded, following (Richter, 2000; Richter and Sailer, 1999) by *CONTENT* values that are essentially feature-structural encodings of terms of higher-order logic (usually Ty2). Unfortunately, this does not make it any easier to say just what exactly indices are supposed to be. If *CONTENT* values are just encodings of Ty2 formulas, this means that the index of a name is a constant; the index of a deictic pronoun is a free variable; the index of a pronoun whose antecedent is a QNP is a bound variable; the index of a direct-object reflexive where the subject is a name is the same constant as that corresponding to the subject; and the index of a QNP is ... what?

This last case is especially problematic, because in a logical translation of of a sentence containing a QNP, where the variable corresponding to the QNP occurs (and indeed, *whether* it occurs) depends on essentially stylistic decisions about the form of the translation. For example, consider the sentence *every boy runs*. For precisely which of the imaginable ways of translating this sentence into Ty2 is the feature-structure encoding of that translation the “real” *CONTENT* value of *every boy runs*? Is it *every'*(*boy'*)(*run'*), which contains no variable occurrences at all? Or is it perhaps the familiar first-order reduction  $\forall x(\text{boy}'(x) \rightarrow \text{run}'(x))$ ? Or, as Quine might have had it,  $\lambda x \top = \lambda x(\text{boy}'(x) \rightarrow \text{walk}'(x))$ ? Given the conventional wisdom that lambda-terms are dispensable—only the denotation in a model, which is invariant under term equivalence, is supposed to matter—it

shouldn't make any difference. But for the HPSG binding theory to work, it is crucial that the indices, whatever they are, be located at the ends of precisely the right paths in the feature structures, so that we can know exactly where to look for the substructures on whose token-(non)identity the entire BT hinges.

Of course one can require that the (feature-structure encodings of) lambda terms corresponding to CONTENT values of nondummy NPs and nonpredicative PPs be written in precisely the right style to guarantee that the right subterm always shows up in the encoding at the end of such-and-such a path; but then it seems evident that there is no natural class of empirical phenomena that BT is constraining; instead one is essentially deciding in advance which kinds of sentences one wants ruled in (or out) by BT and then cooking the representations to ensure that those cases are covered. To put it another way, in the world of real phenomena, there is no such thing as the index of a noun phrase. (We believe this to be a noncontroversial assertion.) So what are we to make of a theory whose predictive power is based on whether or not two given NPs in an utterance have the same index? We will revisit this question in connection with Principle B in section 4.

### 3 Refining the theory of English r-pronouns

#### 3.1 English r-pronouns according to Pollard and Xue

It is well known (Zribi-Hertz 1989, Baker 1995) that, at least in certain literary (especially British) registers, referred to here as Lit./Brit., and under suitable pragmatic conditions, even locally o-commanded reflexives may fail to be coindexed with a local o-commander. The examples in (6) illustrate this point:

- (6) a. (...) his<sub>i</sub> wife was equally incredulous of her innocence and suspected himself<sub>i</sub>, the pastor, to be the cause of her distress, (...)  
(Zribi-Hertz 1989: (37))
- b. Philip<sub>i</sub> was supposed to be fooling (...), because Desiree (...) had undoubtedly explained to them the precise nature of her relationship with himself<sub>i</sub>.  
(Zribi-Hertz 1989: (43b))
- c. But Rupert<sub>i</sub> was not unduly worried about Peter's opinion of himself<sub>i</sub>.  
(Zribi-Hertz 1989: (46b))

In (6a), the object reflexive refers not to the pastor's wife, as Principle A predicts, but rather to the pastor, whose narrative point of view is being reflected. In (6b) and (6c), both of which have a reflexive prepositional object within a PNP, the reflexive refers not to the possessor as predicted by Principle A, but rather someone else who is somehow prominent in the discourse, perhaps the topic or perhaps an individual whose mental state is being described. Zribi-Hertz assumed that in such examples, logophoricity was the operative factor. Baker argued for a different notion of contrastive intensification involving reference to discourse prominent entities. To account for such facts, Pollard and Xue (1998, 2001) proposed the theory of English r-pronouns given in (7):

- (7) A theory of English r-pronouns (Pollard and Xue 1998, 2001):
- a. Principle R:  
Every r-pronoun is either
    - i. coindexed with a local o-commander, or
    - ii. interpreted according to certain pragmatic constraints involving logophoricity, contrastiveness, or discourse prominence.
  - b. Principle A as per (2) (colloquial American English only)

On this account, Principle A is simply absent from Lit./Brit. Instead, it is assumed that a weaker constraint, Principle R, applicable to English in general, requires that any r-pronoun *either* be coindexed with a local o-commander *or* pragmatically constrained (inclusive disjunction)

### 3.2 English reflexives according to Runner and Kaiser

Pollard and Xue continued to assume that Principle A as stated in (2) applies to colloquial American English. But as Runner and Kaiser—and other recent work that they cite, much of it based on carefully controlled experimental investigations—have shown, this cannot be right, because of examples like the ones in (8) where the prepositional object inside a picture NP is not coindexed with the possessive determiner:

- (8) Counterexamples to Pollard/Sag form of Principle A
- a. Ebenezer<sub>i</sub> saw Jacob's<sub>j</sub> picture of himself<sub>i/j</sub>.  
(Runner and Kaiser 2005: (7))
  - b. Manray burned Mary's photo of himself.  
(Runner and Kaiser 2005: (28))

Accordingly, Runner and Kaiser propose to amend Principle A as shown in (9):

- (9) Revised Principle A (Runner and Kaiser 2005):  
Every locally o-commanded reflexive is coindexed with a local d-commander.

Pace Pollard and Sag (and Pollard and Xue), on this account specifiers (including possessive determiners) are not classified as valents (syntactic arguments). Instead, Specifiers and (at least some) adjuncts, as well as valents, are classified as **dependents** (in the sense of Bouma et al. 2001— except that for them, specifiers are not subsumed under dependents). Local d-command is then defined in the same way with respect to dependents as local o-command is with respect to valents. In particular, possessive determiners locally d-command (but crucially do not locally o-command) PP complements of the head noun. With these revisions, the reflexives in (8) become BT-exempt.



### 3.3 A synthesis

Thus Pollard and Xue on the one hand, and Runner and Kaiser on the other, both propose to relax Pollard and Sag's Principle A, in quite different ways, to cover somewhat different sets of facts. Where the two proposals appear to come into competition is in accounting for examples like (6)b,c. However, if we accept that Runner and Kaiser are right about possessive determiners not being arguments, then Principle R can be allowed to stand as stated in (7); it would still cover examples like (6a), but examples like (6)b,c would now be accounted for by Runner and Kaiser's formulation of Principle A. This tentative conclusion is summarized in (10):

(10) Tentative synthetic theory of r-pronouns for English

- a. As per Runner/Kaiser, possessive determiners are dependents (not valents), and locally d-command (not o-command) PP complements of the N.
- b. Principle R (7a)
- c. Principle A as per Runner/Kaiser (9) (colloquial American English only)

### 3.4 A simpler theory?

Can the account in (10) be simplified? Pollard and Xue misassessed the facts, perpetuating the widespread but erroneous belief that examples like (8) were limited to a certain elevated register. But could it be that in reality English r-pronouns, even locally o-commanded ones like the one in (6a), are *never* obligatorily coindexed with a local d-commander, not even in colloquial American English? If so, we could simplify our account to the one in (11):

(11) A possible simpler theory of English r-pronouns

- a. As per Runner/Kaiser, possessive determiners are dependents (not valents), and locally d-command (not o-command) PP complements of the N.
- b. Principle R':  
Every r-pronoun is either
  - i. coindexed with a local d-commander, or
  - ii. interpreted according to certain pragmatic constraints involving logophoricity, contrastiveness, or discourse prominence.

In this theory, Principle R is modified to make reference to local d-command rather than local o-command, and Principle A is dropped altogether. Choosing between this account and the one in (10) comes down to the factual question of whether examples like (6)a are really restricted to a certain register or not. It seems that what is required in order to answer this question is to apply Runner and Kaiser's experimental methodology to a wider range of sentence types, along the lines of (12):

- (12) More facts to assess with varying head types
- a. Manray burned Mary's photo of himself.  
(noun)
  - b. Manray burned Mary's tasteless critique of himself.  
(deverbal noun)
  - c. Manray was outraged at Mary's tasteless criticism of himself.  
(deverbal noun)
  - d. Manray was outraged at Mary's tasteless criticizing of himself.  
(nominal gerund)
  - e. Manray was outraged at Mary's tastelessly criticizing himself.  
(verbal gerund with possessive subject)
  - f. Manray was outraged at Mary tastelessly criticizing himself.  
(verbal gerund with accusative subject)
  - g. Manray was outraged that Mary tastelessly criticized himself.  
(finite verb)

Note that these examples form a cline from purely nominal to purely verbal constructions, with constructions headed by various kinds of deverbal nouns and gerunds occupying the middle ground. Is there a point on the cline beyond which the intended readings are no longer available in colloquial American English? The simpler theory hypothesized in (11) predicts that there is not.

### 3.5 Problems with predicative NPs

Before leaving the topic of English r-pronouns, we briefly consider some seldom-discussed cases that we think merit more careful investigation. It is rare for a head to have both a subject and a specifier (in the limited HPSG sense), which perhaps is one reason why in GB theory subjects were always subsumed under the notion of specifier. But, at least in HPSG terms, one environment where both can occur with the same head is in predicative NPs with possessive determiners, illustrated the examples in (13) and (14):

- (13) Predicative NPs with possessive determiners I: absolutes  
(Pollard and Sag 1994: (56))
- a. With [Kim and Sandy]<sub>i</sub> [each other's]<sub>i</sub> closest confidants, it will be good for them to have a chance to do some travelling together.
  - b. \*With Kim<sub>i</sub> his<sub>i</sub> greatest admirer, it's obvious that he isn't going to win any popularity contests.

(14) Predicative NPs with possessive determiners II: complements  
(Pollard and Sag 1994: (57)-(58))

- a. [Kim and Sandy]<sub>i</sub> are [each other's]<sub>i</sub> greatest admirers.
- b. \*[Kim and Sandy]<sub>i</sub> are their<sub>i</sub> greatest admirers.  
(cf. [Kim and Sandy]<sub>i</sub> met their<sub>i</sub> greatest admirers.)
- c. We<sub>j</sub> consider [Yeltsin and Gorbachev]<sub>i</sub> to be [each other's]<sub>i/\*j</sub> greatest potential allies.
- d. We<sub>j</sub> consider Gorbachev<sub>i</sub> to be our<sub>j</sub>/\*his<sub>i</sub> greatest admirer.  
(cf. We<sub>j</sub> consider Gorbachev<sub>i</sub> to have met his<sub>i</sub> greatest admirer.)

In fact examples like these were Pollard and Sag's motivation for proposing that in cases where both a subject and a specifier occur, the subject locally o-commands the specifier. But now, since we are no longer treating possessive determiners as valents, we must modify this assumption to the form in (15):

(15) If a predicative NP has a possessive determiner, it is locally d-commanded by the NP's subject.

But then what are we to make of examples like the ones in (16)?

- (16) a. John considers Mary the polar opposite of himself.  
b. Mary treats her friends as mere extensions of herself.

In each of these examples, the reflexive PP complement is locally o-commanded by the unexpressed subject of the predicative NP, which in turn is controlled by (and therefore coindexed with) the matrix object. Thus the synthetic theory in (10) wrongly excludes these examples, while the simpler theory in (11) allows them.

But then, how are we to explain (14)c? In that example, according to the simpler theory (11), the reciprocal possessive determiner should be able to have as its antecedent *either* the locally d-commanding unexpressed subject of the predicative NP, which is controlled by the matrix object *Yeltsin and Gorbachev*, *or* the matrix subject *we*, which denotes the individuals whose point of view or mental state is being reported. But Pollard and Sag judged this second ("logophoric") interpretation to be unavailable. Was that judgment simply mistaken? The structurally similar example (17) suggests that it may well have been:

(17) [Kim and Sandy]<sub>i</sub> consider loyalty to be [each other's]<sub>i</sub> most admirable trait.

If this example is acceptable, then it provides further support for the simpler theory.

#### 4 Principle B Reconsidered

We turn now to the seemingly simpler question of how to formulate Principle B. For ease of reference, Runner and Kaiser's formulation of Principle B is given in (18) together with Chomsky's (1986) formulation. Both are paraphrased slightly in order to emphasize their essential similarity:

(18) Two formulations of Principle B

- a. (Runner/Kaiser 2005) No p-pronoun is coindexed with any of its local d-commanders. [**local** = being a codependent of the same head as the p-pronoun].
- b. (Chomsky 1986) No governed pronominal is coindexed with any of its local c-commanders. [**local** = being in an argument position in the governing category of the pronominal.]

Of course these two formulations embody different notions of command and locality; but otherwise they are strikingly similar, especially in assuming that the non-dummy NPs in a sentence actually have things called indices whose identity or lack thereof can be sensibly theorized about.

But of course NP utterances do not come with indices stamped on them that we can check for identity or nonidentity. So then how do we tell whether some version or other of Principle B is making correct predictions? To get a clearer understanding of just what is at issue here, consider the sentences in (19):

(19) Examples typically taken as confirming Principle B

- a. John saw him.
- b. He saw him.
- c. Every man saw him.
- d. Who did Mary say saw him?
- e. John tried to see him.

These are all examples that would typically be taken as confirming evidence for the correctness of Principle B, but in each case the *reason* for taking them as confirming Principle B is different, as shown in (20):

(20) Reasons for taking the examples in (19) as confirming evidence for Principle B: the sentence cannot mean

- a.  $\text{see}'(j, j)$
- b.  $\text{see}'(x, x)$
- c.  $\text{every}'(\text{man}', \lambda x.\text{see}'(x, x))$
- d.  $\lambda p.\text{some}'(\text{person}', \lambda x.p = \text{say}'(x, \text{see}'(x, x)))$
- e.  $\text{try}'(j, \lambda x.\text{see}'(x, x))$

Here we are representing the impossible interpretations by fairly standard lambda terms in some form or other of intensional or hyperintensional logic. If we try to articulate just what it is that is being disallowed, in terms of the syntactic forms of the lambda terms, it seems different in each case, as shown (21):

(21) What is being ruled out, in terms of the form of the logic translation

- a. A pronoun cannot be translated by the same constant as a locally commanding name.

- b. A pronoun cannot be translated by the same variable as a locally commanding pronoun.
- c. A pronoun cannot be translated by the same variable as the one bound by the  $\lambda$  operator corresponding to the scope of the semantic determiner that translates the determiner of a locally commanding NP.
- d. A pronoun cannot be translated by the same variable as the one bound by the  $\lambda$  operator corresponding to an unbounded dependency/A-bar movement if the trace/tail of the corresponding chain locally commands the pronoun.
- e. A pronoun cannot be translated by the same variable as the one bound by the  $\lambda$  operator arising from the translation of a locally commanding “unexpressed subject” (PRO).

The point here is just that if we think of Principle B as a constraint on the syntactic forms of logical expressions that denote the interpretations in question, it does not seem to be expressing a coherent empirical generalization.

One step toward making the five cases above look more alike is to make the assumption in (22):

(22) Assumption about translation of names:

Unless they are de-accented, utterances of names are translated by fresh parameters (variables that cannot be bound).

If this is right, then it seems we may have a chance of dispensing with the notion of index altogether in favor of a constraint on how logical translations are assigned to linguistic expressions, as sketched in (23):

(23) Toward a reformulation of Principle B as a constraint on logical translation:

No p-pronoun is translated by the same variable as any of its local d-commanders.

This of course is of course only a programmatic proposal, not a theory. In order to make sense of it, we must take a lot for granted, including the following

(24) Some presuppositions of (23)

- a. The translation of every nondummy NP, including unrealized ones (such as trace and PRO) consists (at least in part) of an occurrence of a logical variable in an argument position of some atomic formula in the translation (or in some elementary predication in the sense of minimal recursion semantics<sup>5</sup> (MRS, Copestake et al. (in press))).

---

<sup>5</sup>In terms of MRS (or an algorithm for assembly of “unplugged” lambda terms roughly analogous to it), nonidentity of variables per Principle B could be implemented by introducing **variable constraints** of the form  $x \neq y$ , where  $x, y, \dots$  are not true variables but “prevariables” to be replaced by variables subject to the variable constraints at the resolution (or meaning assembly) stage. Such prevariables could be thought of as bearing the same relation to variables over individuals (or individual concepts) that MRS handles bear to variables over propositions.

- b. Some elements (QNPs, PRO, trace, etc.) also contribute a ( $\lambda$ ) operator that binds the contributed variable.
- c. Assembly of the pieces of logical syntax contributed by the words of an utterance into a single term denoting the interpretation of the utterance is in some sense independent of, or subsequent to, the satisfaction of Principle B.

The working out the technical details of such a programmatic proposal is evidently a long-term enterprise, and not one that we are eager to undertake, but this is what seems to be required if we want logical variables to take up the explanatory burden that has been borne by indices.

## 5 Conclusion

In the preceding remarks, we have suggested some revisions of English BT in response to certain classes of data that were problematic for previous formulations. The simpler formulation (11) of Principle A seems to provide a straightforward picture of the connection between reflexivity, argument structure, and logophoricity, though further experimental investigation is needed in order to confirm or disconfirm its predictions. However, this account shares with its many predecessors the uncomfortable positing of indices as theoretical primitives. Eliminating indices in favor of logical variables presents itself as an obvious alternative, but even in the seemingly simpler case of Principle B, where the complicating factors of reflexivity and logophoricity are absent, the technical obstacles to be overcome seem daunting.

Is there a better way? We suspect that there might be. Though the interpretation of pronouns as variables has a venerable pedigree (traceable at least as far back as Montague's PTQ), another possibility, proposed by Pollard and Sag 1983 and Pollard 1984, is that referentially dependent elements (including p-pronouns, r-pronouns, and traces) denote identity functions, and that predicates combine with them not by function application but rather by composition. Unfortunately Pollard and Sag did not pursue this line of investigation, because identity functions, function composition, and their ilk are not comfortably accommodated in the impoverished type theory upon which HPSG is based.<sup>6</sup> However, these same ideas were taken up independently by Jacobson starting in the early 1990s and developed into a highly promising research program (see e.g. Jacobson 1999, 2000, and other works cited there).

Until recently, Jacobson's line of investigation focused on aspects of anaphora orthogonal to BT. However, in recent unpublished work (Jacobson ms.), she has set her sights on Principle B. We did not learn of this in time to make a proper assessment here, but the gist of it is roughly as follows. As in Jacobson's other work, expressions containing an "unbound" pronoun are of a different syntactic type than ones that do not; roughly, they have an implicative (i.e. functional or

---

<sup>6</sup>What is missing is the exponential type-constructor, which gives rise to functional types.

conditional) type, where the antecedent of the conditional is NP (corresponding to the pronoun). What is new is that the functions interpreting such expressions have their domains restricted so as to induce the effect of Principle B, e.g. the interpretation of *Bush praises him* is a function whose domain excludes Bush.

The adjustment of the syntactic type is necessitated by Jacobson's adherence to a principle of strict compositionality in which each syntactic type corresponds to a unique semantic type. This differs from the Pollard and Sag (1983) approach, in which a single syntactic type can correspond to a range of semantic types: a "basic" one for expressions that do not contain any unbound referentially dependent subexpressions, as well as implicative types with that basic type as the final consequent for ones that do. Another difference is that on the Pollard and Sag (1983) approach, the antecedent types corresponding to unbound referentially dependent subexpressions are semantic types, not syntactic ones, reflecting the apparent lack of syntactic connectivity.<sup>7</sup> A third difference is that Jacobson employs only one implicative type constructor (aside from the categorial left and right slashes), whereas Pollard (1984) used different "binding features" (the forerunners of HPSG's nonlocal features) for p-pronouns, r-pronouns, relative pronouns, and interrogative pronouns; on a type-logical recasting of HPSG along the lines of Pollard 2004, these binding features would correspond to different flavors of implication, and "cobound" pronouns to type-logical shifts of the form  $A \Rightarrow (A \Rightarrow B) \vdash A \Rightarrow B$ . We leave the consideration of these and related issues for future exploration.

## References

- Carl Lee Baker. 1995. Contrast, discourse prominence, and intensification, with special reference to locally free relatives in British English. *Language* 71:63-101.
- Gosse Bouma, Robert Malouf, and Ivan Sag. 2001. Satisfying constraints on extraction and adjunction. *Natural Language and Linguistic Theory* 19:1-65.
- António Branco, Francisco Costa, and Manfred Sailer, eds. 2005. *Binding Theory and Invariants in Anaphoric Relations: Binding Theory Workshop Notes*. Technical report TR-05-11, Departamento de Informática, Universidade de Lisboa.
- Noam Chomsky. 1986. *Knowledge of Language*. Praeger, New York.
- Ann Copestake, Daniel Flickinger, Carl Pollard, and Ivan Sag. In press. Minimal recursion semantics: an introduction. To appear in *Research on Language and Computation*.
- Martin Everaert. 1991. Contextual distinction of the anaphor/pronominal distinction. In J. Koster and E. Reuland, eds.
- Karin Golde. 1999. *Binding Theory and Beyond: An Investigation into the English Pronominal System*. Ph.D. dissertation, The Ohio State University.
- Lars Hellan. 1991. Containment and connectedness anaphors. In J. Koster and E. Reuland, eds.

---

<sup>7</sup>Except in the case of traces, where the syntactic category of the trace has to be "remembered" in order to enforce syntactic connectivity in unbounded dependency constructions.

- Pauline Jacobson. 1999. Toward a variable-free semantics. *Linguistics and Philosophy* 22:117-184.
- Pauline Jacobson. 2000. Paycheck pronouns, Bach-Peters sentences, and variable-free semantics. *Natural Language Semantics* 8(2):77-155.
- Pauline Jacobson. Ms. Direct compositionality and variable-free semantics: the case of “Principle B” effects. Manuscript, Brown University.
- Jan Koster and Eric Reuland. *Long-Distance Anaphora*. Cambridge University Press, New York.
- Carl Pollard. 1984. *Generalized Context-Free Grammars, Head Grammars, and Natural Language*. Ph.D. dissertation, Stanford University.
- Carl Pollard. 2004. Type-logical HPSG. In G. Jäger, P. Monachesi, G. Penn, and S. Wintner, eds., *Proceedings of Formal Grammar 2004*. Nancy, France, European Summer School in Language, Logic, and Information, pp. 107-124.
- Carl Pollard and Ivan A. Sag. 1992. Anaphors in English and the scope of the binding theory. *Linguistic Inquiry* 23:261-303.
- Carl Pollard and Ivan A. Sag. 1983. Reflexives and reciprocals in English: an alternative to the binding theory. In M. Barlow, D. Flickinger, and M. Wescoat, eds., *Proceedings of the Second West Coast Conference on Formal Linguistics*, Department of Linguistics, Stanford University, pp. 189-203.
- Carl Pollard and Ivan A. Sag. 1994. *Head-Driven Phrase Structure Grammar*. University of Chicago Press and CSLI Publications, Chicago and Stanford.
- Carl Pollard and Ping Xue. 1998. Chinese reflexive *ziji*: syntactic reflexives vs. nonsyntactic reflexives. *Journal of East Asian Linguistics* 7:287-318.
- Carl Pollard and Ping Xue. 2001. Syntactic and nonsyntactic constraints on long-distance reflexives. In P. Cole, G. Hermon, and C.T. James Huang, eds., *Long-Distance Reflexives*. Syntax and Semantics v. 33, 317-342. Academic Press, San Diego.
- Tanya Reinhart and Eric Reuland. 1991. Anaphors and logophors: an argument structure perspective. In J. Koster and E. Reuland, eds.
- Tanya Reinhart and Eric Reuland. 1993. Reflexivity. *Linguistic Inquiry* 24:657-720.
- Frank Richter. 2000. *A Mathematical Formalism for Linguistic Theories with an Application to Head-Driven Phrase Structure Grammar*. Ph.D. dissertation, Universität Tübingen.
- Frank Richter and Manfred Sailer. 1999. LF conditions on expressions of Ty2: an HPSG analysis of negative concord in Polish. In R. Borsley and A. Przepiórkowski, eds., *Slavic in HPSG*. CSLI Publications, Stanford, pp. 247-282.
- Jeffrey T. Runner and Elsi Kaiser. 2005. Binding in picture noun phrases: implications for binding theory. In A. Branco et al., eds., pp. 53-58.
- Jeffrey T. Runner, Rachel S. Sussman, and Michael K. Tannenhaus. 2002. Logophors in possessed picture noun phrases. *Proceedings of the 21st West Coast Conference on Formal Linguistics*, 401-414.
- Peter Sells. 1987. Aspects of logophoricity. *Linguistic Inquiry* 18:445-479.



Anne Zribi-Hertz. 1989. Anaphora binding and narrative point of view: English reflexive pronouns in sentences and discourse. *Language* 65:695-727.

# Binding conditions: How are they derived?

Eric Reuland 

Utrecht University

Proceedings of the 12th International Conference on  
Head-Driven Phrase Structure Grammar

Department of Informatics, University of Lisbon

Stefan Müller (Editor)

2005

Stanford, CA: CSLI Publications

pages 578–593

Reuland, Eric. 2005. Binding conditions: How are they derived? In Stefan Müller (ed.), *Proceedings of the 12th International Conference on Head-Driven Phrase Structure Grammar, Department of Informatics, University of Lisbon*, 578–593. Stanford, CA: CSLI Publications. DOI: 10.21248/hpsg.2005.33. 

## Abstract<sup>1</sup>

In this article I discuss binding conditions A and B. I show that important properties of binding need not be stipulated, but can be explained as consequences of general properties of the computational system underlying human language.

### 1 Introduction

One of the important foci of linguistic research over the last fifty years or so has been the investigation of language universals. In a sense the result has been somewhat paradoxical. If one considers the range of universals that have been proposed, from Greenberg's word order universals (Greenberg 1963, 1978) to Chomsky's (1981) binding conditions, they all are at least very good approximations. It seems that they must reflect some true insight in the structure of language. Yet, they meet too many empirical challenges to ignore. Moreover, properly considered, their structure is not well-suited to accommodate the attested variation without becoming empirically vacuous. Of course, one may then say that they are statistical rather than unconditional universals, but this raises the question of what these statistical properties/tendencies come from. The paradox is that they are too good to be false, and too bad to be true.

Clearly, what is universal cannot be the macro universals of the Greenberg and Chomsky (1981) type. This warrants a closer scrutiny of what language universals may come from.

If one considers Natural Language as a computational system, one can expect the following Sources of Invariance:

- Type 1. Necessary properties of computations, modulo a medium in which they take place
- Type 2. Economy of computation, modulo resource types and restrictions
  - level of system – level of individual operation  
"grammaticalized" – "non-grammaticalized"
  - global in character
- Type 3. General properties of computations specific to language

---

<sup>1</sup> Support by the Netherlands Organization for Scientific Research NWO is gratefully acknowledged (grant nr. NV-04-09).

I am putting aside lexical-conceptual or, possibly, more general cognitive sources of invariance.

If natural language computations affect structure only in terms of elementary items such as (formal) features there is little reason to expect that computational invariants are realized as "exceptionless" macro-universals of the GB-type. Yet, to the extent that macro-constituents do not vary too much in terms of their feature composition, one may indeed expect that invariants at the computational level do show up at the macro level as good approximations and tendencies.

In this contribution I address the status of the binding conditions within the overall structure of the grammar from the perspective sketched. I argue that apart from the notion of binding itself the grammar need (and hence, should) not contain statements specific to binding. Furthermore, I will argue that at least one principle of binding derives from a type 1 invariant. A property that holds of computations in general (if so, this leads to many further questions). I will adopt the definition of binding in (1) (Reinhart 2000):

- (1) A-binding (logical-syntax based definition)<sup>2</sup>  
 $\alpha$  A-binds  $\beta$  iff  $\alpha$  is the sister of a  $\lambda$ -predicate whose operator binds  $\beta$

I will focus on binding conditions A and B, and discuss how they can be derived from general properties of the computational system. This involves investigating binding possibilities of elements in terms of:

A) their intrinsic feature content (only features that are independently motivated, such as *person*, *number*, *gender*, etc., not: +/- anaphor, +/- pronominal, etc.)

B) their internal structure (pronoun, additional morphemes)

C) the interaction of these elements with the linguistic environment (semantic and syntactic) as it is driven by their features.

## 2 Condition B: Why must reflexivity be licensed?

The starting point is the question of what is wrong with "brute force reflexivization" (=coargument binding without additional licensing). I will show that the core cases of condition B as formulated in Reinhart

---

<sup>2</sup> *Logical syntax* is a regimented representation of linguistic structure at the conceptual-intentional (C-I) interface that results from the translation/interpretation procedures applying to expressions of narrow syntax.

and Reuland (1993) can be derived from (2) as a general property of computational systems:

(2) ***IDI=Inability to Distinguish Indistinguishables.***

The IDI is not specific to language, hence the investigation of condition B leads us "beyond explanatory adequacy" (Chomsky 2004).

Consider the general structure in (3a), instantiated in (3b) and (3c), where *zich* is a SE-anaphor.

- (3) a. *DP V Pronoun*  
 b. \**Jan* haat *zich* (Dutch)  
     John hates SE  
 c. \**Jan* hatet *him* (Frisian)

By assumption V is a 2-place predicate that has to assign different theta-roles to subject and object. Hence, two different grammatical objects are required to bear the theta-roles (theta-criterion). Translating pronouns as variables together with the definition of binding yields:

(4)  $DP \lambda x [x V x]$

(4) contains two tokens of the variable x. The claim is that due to IDI the computational system cannot read them as two objects. Two tokens of the same element can only be distinguished if they qualify as different occurrences (Chomsky 1995: an occurrence of x is the expression containing x minus x). The tools for keeping track are *order* and *hierarchy*. But, order is a PF property and not available at the C-I interface. Purely syntactic hierarchy is broken down by the interpretive procedures at the C-I interface (eliminating X' and equivalents). Translating *DP V pronoun* at the C-I interface involves the steps in (5):

$$(5) \quad \underset{1}{[_{VP} x [_{V'} V x ]]} \rightarrow ([_{VP} V \text{"x x"}]) \rightarrow \underset{2}{[_{VP} V x]} \underset{3}{*}$$

The second step with the two tokens of x in "x x" is virtual (hence put in brackets). With the breakdown of structure, and the absence of order, stage 2 has no status in the computation. Hence, eliminating V' leads directly to stage 3. Since one theta-role cannot be assigned in

stage 3 (or two roles are assigned to the same argument) it leads to a theta-violation. Thus the prohibition of "brute force" reflexivization is derived.

The issue is how to obtain a reflexive interpretation while avoiding "brute force reflexivization. There are two options: i) make the argument structure compatible with this effect of IDI → apply a lexical or syntactic reduction operation on the argument structure, licensing valence reduction; ii) keep the two arguments formally distinct by protecting a variable.

## 2.1 Valence reduction

Reinhart (2002) and Reinhart and Siloni (2005) develop a theory of operations on argument structure. Among these operations are Passive, Middle formation, (De)causativization and *Reflexivization*. The latter operation reduces the valence of the verb, and bundles the theta-roles. In many languages, however, verb classes exist that resist reflexivization by valence-reduction. With such verbs reflexivity must be licensed by protecting the variable.

## 2.2. Protecting a variable.

As will be argued, any embedding of the second argument in a structure that is preserved under translation into logical syntax will do to keep the arguments distinct. I use the term *reflexive-licenser* (or briefly licenser) to refer to the morphological elements that are used to achieve this. The general structure is illustrated in (7a) and (7b), a particular instance is *zelf* in *Jan bewondert zichzelf* 'John admires himself':

- (7) a.  $DP\ V\ [Pronoun\ Morph]$   
 b.  $DP\ \lambda x\ [V(x,\ [x\ M])]$

The freedom of the choice and interpretation of M are limited by conditions of use: (7b) should be useable to express a reflexive relation. Thus, if M is interpreted as yielding some function of x, use restricts what are admissible values. This is stated in (8) (Reuland 2001):

- (8)  $DP\ (\lambda x\ V(x,\ f(x)))$

Condition:  $\|f(x)\|$  is sufficiently close to  $\|x\|$  to stand proxy for  $\|x\|$

The condition in (8) represents a requirement of FIT: *An encoding should FIT conditions of use.*

### 3 Enforcing reflexivity: Condition A

Some reflexive licensers enforce reflexivity (for instance, English SELF). This is standardly reflected in condition A as a property of SELF-anaphors. The question is why reflexive licensers would have this property. It does not follow from their role in protecting the variable. Moreover other licensers of reflexivity don't have this effect. This is illustrated by the contrast between English and Malayalam in (10), which does not require local binding of the licenser (Jayaseelan 1998):<sup>3</sup>

- (10) a. raaman<sub>i</sub> tan-ne<sub>i</sub> \*(tanne) sneehikunnu  
 Raman SE-acc self loves  
 Raman loves him\*(self)
- b. raaman<sub>i</sub> wicaariccu [penkuttikal tan-ne<sub>i</sub> tanne sneehikkunnu ennə]  
 Raman thought girls SE-acc self love Comp  
 'Raman thought that the girls love *himself*'
- c. \*Raman<sub>i</sub> thought that the girls love himself<sub>i</sub>

Locality is not an absolute property of *self*, even in English, witness the contrast in (11) extensively discussed by Pollard and Sag (1992, 1994), Reinhart and Reuland (1991, 1993) and many authors cited there.

- (11) a. \*Max<sub>i</sub> expected the queen to invite himself<sub>i</sub> for a drink  
 b. Max<sub>i</sub> expected the queen to invite Mary and himself<sub>i</sub> for a drink  
 c. Max<sub>i</sub> expected the queen to invite no one but himself<sub>i</sub> for a drink

---

<sup>3</sup> Cole, Hermon and Tjung (2004) discuss the anaphor *awake dheen* in *Peranakan Javanese* which has similar properties.

When the SELF-anaphor is not a syntactic argument of the predicate it does not have to be interpreted as a reflexivizer, but if it is it must. Suppose that in English reflexivization by SELF takes place by covert adjunction of SELF to the predicate as in (12).

- (12) a. DP .... [V] [<sub>DP</sub> PRON [ SELF]]  
 b. DP .... [SELF V] [<sub>DP</sub> PRON [ e]]

If so, the contrast in (11) follows from restrictions on movement. Assuming that there is no intrinsic property of *himself* that forces it to be bound, or of SELF that forces it to be moved, the well-formedness of (11b,c) also follows. But the question is why it has to move if it can as in (11a) where the result is illformed. The explanation should not be specific for SELF, since in languages with body-party reflexives reflexivizing may also be enforced (e.g. in Georgian, see Amiridze in prep). There are a number of possible scenarios for the obligation to reflexivize of which I mention two: i. a lexical semantics-based scenario; ii. an inalienable possession-based scenario. Both allow us to derive instances of condition A without any assumption that is specific to binding. Yet, unlike in the case of condition B some properties of grammar will be involved that may well be specific to language. But first some remarks on how the computational and interpretive systems interact.

With Chomsky (1995, and subsequent work) I assume that Merge, as the basic operation for forming complex expressions, comes in two forms: Set-merge and Pair-merge. Set-merge reflects predicate-argument relations, Pair-merge yields adjunction structures, and is interpreted as modification. A canonical way of interpreting modification structures is by *intersection*. Chomsky (2001) posits *interpretation by intersection* as the mechanism of choice for adjunction (pair-merge) in general. This general mechanism is also found where we don't have a typical modification relation. For instance, De Hoop (1992) argues that bare plural objects in Dutch (and other languages) should be interpreted by an incorporation mechanism. The syntactic mechanism expressing incorporation is head-adjunction. Interpretation as intersection will play a key role in the interpretation of SELF-marking. In the analysis I will present in the next section, SELF-marking is a subcase of a more general mechanism. This general mechanism will be explained on the basis of a model based on the Inalienable Possession relation, for short, the IP-model.



### 3.1 Introducing the IP model

According to Pica (1987, 1991) "inalienable possession" constructions provide a model for complex reflexives (see Everaert 2004 for further discussion). But so far no full implementation has been put forward, and there are complications that require attention. Some typical IP constructions do indeed share with reflexives "obligatoriness of binding". So, we have *John craned his neck*, *Everyone craned his neck*, but not *\*I craned his neck*. However, many cases are idiomatic (to varying degrees); and in non-idiomatic cases, the obligation appears to cease. Compare (13)-(15):

- (13) a. John raised his eyebrows  
b. \*I raised his eyebrows
- (14) a. John sprained his ankle  
b. \*(?)I sprained his ankle.
- (15) a. During the fight, John twisted his ankle  
b. During the fight, I twisted his ankle

Yet, there is a contrast between (15a) and (15b): under the IP-reading *twist* is not agentive: John is an experiencer rather than an agent in (15a) and (14a). Also, (15a) means that John sustained an injury, contrary to (15b).<sup>4</sup> So, in these cases the IP and the non-IP versions of the predicate are not identical. Also compare (16a) and (16b):

- (16) a. John proffered his hand  
b. John proffered his bottle

*John* is an agent in some sense in both cases, but there is a significant difference: (16a) does not express a relation between "independent objects". In (16b) John performs a transaction on a bottle, whereas in (16a) John does not perform a transaction on a hand. The transaction can be completed in (16b) by transferring possession of the bottle, but not in (16a) (unless, of course, by severing the hand, but this gives us again the bottle-case). This contrast will help us find an effective characterization of true IP. Note, that it is not the case that in the

---

<sup>4</sup> As pointed out by Alexis Dimitriadis (personal communication).

structure DP V [<sub>IP</sub> Poss NP]], Poss is always obligatorily bound by DP. This is illustrated by the examples in (17):

- (17) a. John<sub>i</sub> hit his<sub>i,j</sub> knee (no bias)  
b. John<sub>i</sub> hated his<sub>i,j</sub> face (no bias)  
c. John<sub>i</sub> hated his<sub>i,j</sub> body (slight bias, but:)  
d. I hated his<sub>i</sub> body (fine)  
e. John<sub>i</sub> hated his<sub>j</sub> guts (somebody else)

Such facts indicate that deriving the binding obligation of *complex anaphors* from an IP type strategy requires at least some additional assumption. What (16) shows is that the inalienably possessed element is not referential in the way canonical arguments are.<sup>5</sup> If so, the following scenario applies, again leading to a derivation based on covert *adjunction/incorporation*.

Starting point is the structure in (18) (with BP instead of SELF)

- (18) a. DP .... [V] [<sub>DP</sub> PRON [ BP]]  
b. DP .... [BP V] [<sub>DP</sub> PRON [ e]]

The assumptions and steps that are needed for a blind, automatic syntactic procedure are sketched in the next section.

### 3.2 Implementation

Most work within the minimalist program assumes that movement has to be triggered by a feature checking/agree under a probe-goal relationship. It has been proposed, however, that movement may also be licensed by the necessity to meet interface conditions which could otherwise not be met (see, for instance, Reinhart 1997, 1998), or that movement is triggered by optional features whose presence is motivated by a similar consideration (for instance, the optional EPP feature licensing Object shift, Chomsky 2001). Trivially, the obligation for BP/SELF movement can always be encoded with a feature as the trigger. Here, I will adopt a more principled alternative based on Reuland (2001).

---

<sup>5</sup> Such a use of the notion of referentiality glosses over important issues, but for current purposes it will do.

Reuland (2001) derives the chain condition effects discussed in Reinhart and Reuland (1993) from economy considerations. Consider the contrast between (19) and (20):

(19) *Jan* voelde [*zich* wegglijden]  
'John felt himself slide away'

(20) \**Jan* voelde [*hem* wegglijden]  
'John felt him slide away'

In logical syntax both sentences are represented by (21):

(21) Jan ( $\lambda x$  (x felt [x slide away])

As I argue there, the dependency between *Jan* and *zich* (which has unvalued features for number and gender) in (19) can be syntactically encoded with a feature chain, the number feature on *hem* in (20) blocks chain formation (see Reuland 2005b for an implementation based on Agree in the framework of Pesetsky and Torrego 2004a,b). Encoding an interpretive dependency by  $C_{HL}$  is hard and fast, and takes precedence over encoding the dependency at the interface. If a syntactic strategy is possible it is obligatory. Consequently, (20) is not ruled out because of a crash of some sort, but simply because the alternative, cheaper derivation of the interface representation (21) blocks it.

Here I will show that nothing more than this economy condition and a general requirement of FIT are needed to derive the binding obligation of both SELF and BP anaphors.

As stated above, the mechanism is (covert) head movement by adjunction of BP-head/SELF onto the predicate head.

(22) a. DP .... [V] [<sub>DP</sub> PRON [ BP]]  
b. DP .... [BP V] [<sub>DP</sub> PRON [ e]]

The interpretation of Bodypart and SELF reflexives now follows from (23) (as stated above) and their properties as stated (24) (see Reuland, to appear, for more extensive discussion):

(23) *Adjunction structures are interpreted by intersection* (Chomsky 2001).

- (24) Crucial properties of the Bodypart-head and SELF:
- i. BP-head/SELF is a relational N
  - ii. The semantic properties of BP/SELF: The semantic properties of BP/SELF impose restrictions on the choice of the value of one argument in terms of the value of the other one. Possibly as strong as identity in the case of SELF, minimally as strong as the requirement that values of the internal argument can stand proxy for the values of the external argument ( $x$  and *the body of x*).

Intersecting the relation  $R_{\text{PRED}} = \langle x, y \rangle$  with the relation  $R_{\text{IP}} = \langle x, \text{BP}(x) \rangle$ , yields the relation  $R_r = \langle x, \text{BP}(x) \rangle$  as a subset of  $R$ . In so far as  $\text{BP}(x)$  can stand proxy for  $x$ ,  $R_r = \langle x, \text{BP}(x) \rangle$  can stand proxy for a reflexive relation  $R_{\text{reflexive}} = \langle x, x \rangle$ .

As I said, the trigger for the adjunction is economy of encoding. Whether or not Morph will obligatorily adjoin to  $V$  will be determined by FIT. Adjunction of Morph onto  $V$ , deriving (25b) from (25a) is obligatory if the condition of (25c) is met:

- (25) a.  $DP\ V\ [\textit{Pronoun}\ \text{Morph}]$   
 b.  $DP\ \text{Morph-}V\ [\textit{Pronoun}\ (\text{Morph})]$   
 c. FIT:  $\|M \oplus V\|$  can stand proxy for  $\lambda x (x\ V\ x)$

The relevant condition is that  $\|M \oplus V\|$  be a relation that comes sufficiently close (= FITs) to the intended reflexive relation with  $DP$  binding *Pronoun* to be usable to refer to it. Thus the binding obligation on BP's and SELF has been derived from very general properties of the linguistic computation, and the requirement of FIT on the outcome.

From this perspective, cross-linguistic variation in binding requirements should be reducible to the ability to undergo head-movement and/or meet FIT. Let's assume that grammaticalization has sufficiently bleached some Morph to meet a requirement of FIT between  $x$  and  $f(x)$ . Hence it can protect the variable and prevent a condition B violation. Yet it is conceivable that nevertheless  $M \oplus V$  cannot be formed, since Morph is intrinsically unable to undergo head-movement and incorporate. For instance, this could hold of certain pronominals. If so, we have the Malayalam type of anaphoric system. In other languages it could be the case that  $\|M \oplus V\|$  cannot stand proxy for  $\lambda x (x\ V\ x)$ . For the moment I will leave it at these remarks.

Definitive conclusions require more in-depth analyses of cross-linguistic variation than is currently available.

#### 4 By way of conclusion

We saw that condition B instantiates the case where a principle of grammar reflects a general property of computation. What about condition A? Merge (both external and internal) in its most minimal form is just a property of any computational system (Chomsky 1995, 2001, 2005). Locality conditions, as the condition on head movement, may well be specific to language, although the issue cannot be considered settled. A crucial issue involves economy. Economy as conceived in Chomsky (1995) was a global principle comparing derivations. Subsequently, in order to avoid computational explosions, it has been proposed to build the economy considerations into the linguistic operations themselves, for instance in the locality of probe-goal relationships. Even so, technically the comparison between (19) and (20) violates one of the basic conditions for economy as originally conceived since the selection of items (the numeration) in (19) and (20) differs. A technical solution to this problem is to treat functional material differently from lexical material (Hornstein 2004).

However, I will suggest that the notion of Economy that is needed here warrants a different account. To my mind it reflects the same property of our linguistic system that is involved in the phenomenon known as *grammaticalization*.

Although there is little discussion of grammaticalization in the generative literature, with the notable exception of Newmeyer (for instance, Newmeyer 1998), bleaching of the meaning of lexical items and concomitant grammaticalization are undeniably driving forces behind linguistic change

As pointed out in Reuland (2005a), grammaticalization phenomena are standardly seen as just the result of inexorable forces that shorten and empty frequent words, reducing and devoiding of content the more frequent features. They eventually lose their expressiveness in the language. When this happens, other expressions are cannibalized to put them in their place, replenishing what has been lost by new word formations in a never-ending cycle. In this framework one is inclined to take such phenomena as facts, that just happen to be true. However, alternatively, one may pose the question

as to why there is grammaticalization. Why does it take place, if the only result it has is a never-ending cycle?

I propose the following answer as to what drives grammaticalization. Grammatical computation essentially involves blind operations on 'formal objects' without reference to interpretation, precisely because that is efficient. You never have to stand still and look back until you're done. Of course, in order to be useful, any computation will have to involve the concepts in which we organize the world in the end. This implies that any property of a concept that is relevant for the way the computation is being performed must be formally coded. It is for this reason that there is an advantage in grammaticalization, precisely because it makes available the means to formally encode properties and triggers for operations.

From this perspective, the phenomenon of 'grammaticalization' is not a quirk, an effect of historical development just resulting from frequency driven processes of attrition. Rather 'formalization' is essential to grammar. Case, agreement, categorial features, they all facilitate the formal encoding of dependencies, for fast, blind computation. Thus dependencies can be established without having to inspect anything beyond the formal properties of the objects involved.

Of course, this still raises the question how the grammar 'knows' what operations are economical. In Reuland (2001) I proposed that it is cross-modular operations that contribute to cost. So, essentially, the grammar is like a lazy cyclist, who keeps pushing the pedals, his gaze at infinity, his mind at zero. No further information enters his consciousness, hence in this mode no action can be taken that requires such information. (And of course, this lazy cyclist is therefore highly accident prone.) If so, it is at the level of selection of lexical items that local decisions minimizing demand on resources may favour grammaticalized over non-grammaticalized elements where the choice exists. It is in fact not unrealistic that the brain structures subserving automatized processes are functionally distinct from those structures subserving more conscious processes (Ullman 2004). If this reasoning is correct, the notion of economy selects anaphors over pronominals and makes reflexive licensors into obligatory reflexivizers is nothing but the reflex in grammar of general principles favoring minimal demands on resources. This makes condition A into a type 2 invariant as defined in section 1, modulo a possible language specific restriction on head-movement.

## References

- Chomsky, Noam. 1995. *The Minimalist Program*. Cambridge, Mass. MIT Press
- Chomsky, Noam. 2001. Derivation by Phase. In Michael Kenstowicz, ed., *Ken Hale: a Life in Language*. Cambridge, Mass.: MIT Press
- Chomsky, Noam. 2004. Beyond Explanatory Adequacy. In Adriana Belletti, ed. *Structures and Beyond – The Cartography of Syntactic Structure*, Vol 3. Oxford: Oxford University Press
- Chomsky, Noam. 2005. On Phases. Ms. MIT
- Cole, Peter, Gabriella Hermon and L.-M. Sung. 1990. Principles and Parameters of Long Distance Reflexives. *Linguistic Inquiry* 21, 1-23
- Cole, Peter, Gabriella Hermon and Yassir Tjung. 2004. A Binding Theory Exempt Anaphor in Javanese. Paper presented at the workshop on *Reciprocity and reflexivity -- description, typology and theory*. October 1-2 2004, FU Berlin, Ms. Max Planck Institute for Evolutionary Anthropology Leipzig and University of Delaware
- Everaert, Martin. 2003. Reflexives in discourse. In Jan Koster and Henk van Riemsdijk, ed. *Germania et Alia*. A Webschrift for Hans den Besten. <http://odur.let.rug.nl/~koster/DenBesten>
- Greenberg, Joseph (ed.). 1963. *Universals of languages*. Cambridge, Mass.: MIT Press.
- Greenberg, Joseph (ed.). 1978. *Universals of human language* Vol. 4: *Syntax*. Stanford, California: Stanford University Press.
- Hoop, Helen de. 1992. *Case Configuration and Noun Phrase Interpretation*. Diss. Groningen University
- Hornstein, Norbert. 2004. *Pronouns in a Minimalist Setting*. Paper presented at the Workshop *The Copy Theory on the PF side*, Dec. 14-15. Utrecht institute of Linguistics OTS,.
- Jayaseelan, K.A. 1997. Anaphors as Pronouns. *Studia Linguistica* 51.2, 186-234
- Newmeyer, Fritz. 1998. *Language form and language function*. Cambridge: MIT Press.
- Pesetsky, David & Torrego, Esther. 2004a. Tense, Case, and the Nature of Syntactic Categories. In *The Syntax of Time*, ed. Jacqueline Gueron and Jacqueline Lecarme. Cambridge: MIT Press.

- Pesetsky, David & Torrego, Esther. 2004b. The Syntax of Valuation and the Interpretability of Features. Ms. MIT & UMass/Boston.
- Pica, Pierre. 1987. On the Nature of the Reflexivization Cycle, *NELS* 17: 483-499
- Pica, Pierre. 1991. On the interaction between antecedent government and binding: the case of long-distance reflexivization. In *Long distance Anaphora*, ed. Jan Koster and Eric Reuland, 119-135. Cambridge, UK: Cambridge University Press.
- Reinhart, Tanya. 1997. Quantifier-Scope: How labor is divided between QR and choice functions. *Linguistics and Philosophy*, 20, 335-397
- Reinhart, Tanya. 1998. Wh-in-situ in the framework of the Minimalist Program. *Natural Language Semantics* 6:1, 29-56
- Reinhart, Tanya. 2000. Strategies of Anaphora Resolution. In *Interface Strategies*, ed. Hans Bennis, Martin Everaert and Eric Reuland, 295-325. Amsterdam: Royal Academy of Sciences
- Reinhart, Tanya. 2002. The Theta System - an Overview. *Theoretical Linguistics* 28(3)
- Reinhart, Tanya, and Eric Reuland. 1991. Anaphors and Logophors: An Argument Structure Perspective. In *Long distance Anaphora*, ed. Jan Koster and Eric Reuland, 283-321. Cambridge, UK: Cambridge University Press.
- Reinhart, Tanya and Eric Reuland. 1993. Reflexivity. *Linguistic Inquiry* 24.4, 657-720
- Reinhart, Tanya and Tal Siloni. 2005. The Lexicon-Syntax Parameter: Reflexivization and Other Arity Operations. *Linguistic Inquiry*, 389 - 436
- Reuland, Eric. 2001. Primitives of Binding. *Linguistic Inquiry* 32.2, 439-492
- Reuland, Eric. 2005a. On the evolution and genesis of language: the force of imagination. *Lingue e Linguaggio* 1, 81-110
- Reuland, Eric. 2005b. Agreeing to bind. Ms Utrecht institute of Linguistics OTS.
- Reuland, Eric. To appear. Anaphoric dependencies: How are they encoded? Towards a derivation-based typology. In *Reciprocals and Reflexives – Cross-linguistic and theoretical explorations*, ed. Ekkehard König and Volker Gast.



- Schladt, Mathias. 2000. The typology and grammaticalization of reflexives. In *Reflexives: Forms and Functions*, ed. Zygmunt Frajzyngier and Traci Curl. Amsterdam: Benjamins.
- Ullman, Michael. 2004. Contributions of Neural Memory Circuits to Language: the declarative/procedural model. *Cognition*. 92. 231-270.
- Zwarts, Joost. 1992. *X' Syntax - X' Semantics: On the Interpretation of Lexical and Functional Heads*. Doctoral Dissertation. Utrecht University.

# Binding in picture noun phrases: Implications for Binding Theory

Jeffrey T. Runner 

University of Rochester

Elsi Kaiser 

University of Southern California

Proceedings of the 12th International Conference on  
Head-Driven Phrase Structure Grammar

Department of Informatics, University of Lisbon

Stefan Müller (Editor)

2005

Stanford, CA: CSLI Publications

pages 594–613

Runner, Jeffrey T. & Elsi Kaiser. 2005. Binding in picture noun phrases: Implications for Binding Theory. In Stefan Müller (ed.), *Proceedings of the 12th International Conference on Head-Driven Phrase Structure Grammar, Department of Informatics, University of Lisbon*, 594–613. Stanford, CA: CSLI Publications. DOI: 10.21248/hpsg.2005.34. 

## **Abstract**

This paper investigates the binding of pronouns and reflexives in “picture” noun phrases, and focuses on data showing that reflexives and pronouns are not in complementary distribution in picture NPs with possessors. In particular, we discuss data showing that whereas reflexives can take either the possessor or the subject of the sentence as antecedent, pronouns are restricted to an antecedent other than the possessor phrase. We suggest that this asymmetry can be straightforwardly explained if we assume that (1) the possessor of a picture NP is not part of the head noun’s argument structure and (2) Binding Theory is stated over “dependents” structure, the representation encompassing both a head’s argument structure and other phrases dependent on it in various ways. If the possessor of a picture NP (PNP) is not part of the head’s argument structure, it follows that reflexives in PNPs with possessors will be “exempt” from Binding Theory, which paves the way for an analysis of the reflexive data. Furthermore, we also show that if BT is regarded as defined over dependents structure, it follows that a pronoun in a picture NP with a possessor must be disjoint from that possessor phrase.

## **1 Introduction**

This paper investigates the binding of pronouns and reflexives in “picture” noun phrases, and focuses on data showing that reflexives and pronouns are not in complementary distribution in picture NPs with possessors. In particular, we discuss data showing that whereas reflexives can take either the possessor or the subject of the sentence as antecedent, pronouns are restricted to an antecedent other than the possessor phrase. We suggest that this asymmetry can be straightforwardly explained if we assume that (1) the possessor of a picture NP is not part of the head noun’s argument structure and (2) Binding Theory is stated over “dependents” structure, the representation encompassing both a head’s argument structure and other phrases dependent on it in various ways. If the possessor of a picture NP (PNP) is not part of the head’s argument structure, it follows that reflexives in PNPs with possessors will be “exempt” from Binding Theory, which paves the way for an analysis of the reflexive data. Furthermore, we also show that if BT is regarded as defined over dependents structure—as opposed to argument structure—it follows that a pronoun in a picture NP with a possessor must be disjoint from that possessor phrase.

The remainder of Section 1 outlines the basic data we focus on. In Section 2 we provide three arguments from the interpretation of reflexives and pronouns that the possessor and the postnominal phrase in a PNP are not co-arguments. In Section 3 we provide some independent support for the

claim that a postnominal reflexive is exempt from Binding Theory and is susceptible to discourse and pragmatic factors. Section 4 outlines a new view of Binding Theory defined over dependents structure, from which it follows that a pronoun in a picture NP with a possessor must be disjoint from that possessor phrase. Section 5 explores alternative analyses and outlines some lingering issues for future work.

### 1.1 Possessed Picture NPs

Most approaches to Binding Theory predict that a reflexive in a PNP with a possessor phrase is bound by that possessor (see (1)), and that a pronoun in a PNP is disjoint from the possessor (see (2)).

- (1) Ebenezer<sub>i</sub> saw Jacob<sub>j</sub>'s picture of himself<sub>j/\*i</sub>.
- (2) Ebenezer<sub>i</sub> saw Jacob<sub>j</sub>'s picture of him<sub>i/k/\*j</sub>.

These predictions are made by the classic Principles & Parameters Binding Theory of Chomsky (1981, 1986), the “reflexivity” approach of Reinhart & Reuland (1993), as well as most versions of the HPSG Binding Theory, beginning with Pollard & Sag (1992, 1994), and more recently in Manning & Sag (1999). The predictions follow from two claims: (1) that reflexives and pronouns are in complementary distribution, which means that in a given binding domain, the sets of referents available to a reflexive and a pronoun are not overlapping; and (2) that a PNP containing a possessor phrase is a domain for binding. We will illustrate the HPSG analysis of (1) and (2) with the Manning & Sag (1999) version of the Binding Theory. The intuition behind the Manning & Sag approach is that Binding Theory is defined over the argument structure (ARG-ST) list (see (4)).

- (3) HPSG Binding Theory (Manning & Sag 1999)
  - Principle A: A locally a-commanded anaphor must be locally a-bound
  - Principle B: A personal pronoun must be locally a-free
  - Principle C: A non-pronoun must be a-free
- (4) A-command: If A precedes B on some argument structure (ARG-ST) list, A a-commands B.  
 A-binding: A a-binds B if A a-commands B and A and B are coindexed.

The data in (1) and (2) follow from the assumption that the head noun ‘picture’ has an ARG-ST containing both ‘Jacob’ and the ‘himself’/‘him’, as in (5) and (6):

- (5) ARG-ST: <[<sub>NP</sub> Jacob]<sub>j</sub>, [<sub>NP</sub> himself]<sub>j</sub>>  
 (6) ARG-ST: <[<sub>NP</sub> Jacob]<sub>j</sub>, [<sub>NP</sub> him]<sub>\*j</sub>>

For (1), since the anaphor ‘himself’ is a-commanded, it must be a-bound, in this case implying that it must be coindexed with ‘Jacob’. For (2), the pronoun must not be a-bound, which means it can have any index but that of ‘Jacob’. Thus, the complementary distribution of reflexives and pronouns is accounted for on the assumption that the NP is the domain for binding.

However, a number of recent studies (Runner, Sussman & Tanenhaus 2002, 2003, to appear; Keller & Asudeh 2001; Asudeh & Keller 2001; Jaeger 2004) have experimentally investigated these predictions with respect to PNPs containing possessors, and the findings indicate that reflexives and pronouns are not in complementary distribution in PNPs containing possessors. In particular, reflexives are not limited to taking only the possessor as antecedent; the subject of the sentence may also be the antecedent (see (7)). However, a pronoun in the same position is constrained to be disjoint from the possessor phrase (see (8)). Since the pronoun and the reflexive can both take the subject of the sentence as antecedent, this means their referential domains are partially overlapping; in addition, for the reflexive at least, the domain of binding cannot be restricted to the PNP.

- (7) Ebenezer<sub>i</sub> saw Jacob<sub>j</sub>'s picture of himself<sub>j/i</sub>.  
 (8) Ebenezer<sub>i</sub> saw Jacob<sub>j</sub>'s picture of him<sub>i/k/\*j</sub>.

## 1.2 The ARG-ST of Possessed PNPs

We begin by illustrating that if one abandons the claim that the possessor and postnominal phrase are co-arguments, an account of the binding in (7) can be developed. Since Principle A constrains only locally a-commanded anaphors, it follows that if an anaphor appears in an ARG-ST, but has no a-commanding co-arguments, Principle A is satisfied vacuously (see (9)):

- (9) ARG-ST: <[<sub>NP</sub> himself]>

Pollard & Sag (1992, 1994) call an anaphor with no a-commanding co-argument an “exempt” anaphor, and suggest that its distribution is constrained by pragmatic and discourse factors instead of structural Binding Theory. Reflexives in PNPs lacking possessor phrases are one of the ‘classic’ examples of exempt anaphors. It is well known that reflexives in simple PNPs can have antecedents outside the PNP, as in (10). Indeed, these exempt anaphors even occur with clause-external (or sentence-external) antecedents, as in (11) and (12) respectively. Researchers have suggested that non-syntactic factors may guide/license the use of such exempt anaphors. For

example, Pollard and Sag argue that something like the discourse notion of “point of view” is relevant to licensing the use of these exempt anaphors, see (12) vs. (13). In (12), which is interpreted from John’s perspective, the reflexive is acceptable, but in (13), in which the perspective is Mary’s, it is not.

- (10) John<sub>i</sub> saw [a picture of himself<sub>i</sub>].
- (11) John<sub>i</sub> said that there was [a picture of himself<sub>i</sub>] in the post office.
- (12) John<sub>i</sub> was going to get even with Mary. That picture of himself<sub>i</sub> in the paper would really annoy her, as would the other stunts he had planned.
- (13) Mary was quite taken aback by the publicity John<sub>i</sub> was receiving. \*That picture of himself<sub>i</sub> in the paper would really annoy her, as would the other stunts he had planned.

Let us now return to PNPs with possessors. In these constructions, if we assume that the possessor is not represented as part of the ARG-ST of the noun ‘picture’, the reflexive is alone on the ARG-ST, as in (9)—which makes it an exempt anaphor, according to Pollard and Sag’s approach. Under the view that this reflexive is an exempt anaphor, its choice of antecedent is not determined by Binding Theory, but rather by pragmatic and discourse-level factors. In an experimental investigation, Runner et al. (2003) found a preference for the possessor over the subject: participants chose the subject as antecedent on about 25-30% of the time, and the possessor on 70-75% of the time. The fact that the possessor was chosen significantly less often than the 100% predicted by Binding Theory suggests that antecedent choice is not guided purely by Binding Theory.

However, these experiments did not specifically set out to determine which discourse/pragmatic factors guide antecedent choice. In order for the non-co-argument account to succeed, further research is needed to investigate whether pragmatic and discourse factors are responsible for this pattern, and which factors are relevant. Moreover, the possessor preference may be related to locality conditions on anaphoric reference, which may be a factor that is related to or in addition to the other relevant discourse factors. We emphasize the importance of these issues as topics of future work.

It is worth noting that although the assumption that the possessor is not in the ARG-ST of the noun ‘picture’ seems to offer a way of capturing the reflexive data in (7), it results in the loss of the explanation for the fact that a pronoun in the same position must be disjoint from the possessor (see (8)). This disjointness only follows from Binding Theory if the possessor is on the ARG-ST of the head noun.

Thus, the question of whether the possessor phrase is a co-argument of the postnominal phrase is crucial to the analysis of (7) and (8). In the next sections, we provide evidence that it is not. Our argument has two parts. First, we present several independent reasons for not treating the possessor and the

postnominal phrase as co-arguments; these include the fact that a postnominal reflexive can be interpreted coreferentially under ellipsis and in the ‘only’ construction, and that a postnominal pronoun can be interpreted distributively. Then, we discuss findings showing that reflexives in PNPs are sensitive to discourse/semantic factors—which is expected if they are exempt anaphors due to not being co-arguments with the postnominal phrase. In the last part of the paper, we return to the disjoint pattern for pronouns.

## 2 The PNP Possessor

### 2.1 Reflexive Interpretations: Ellipsis

The first argument against treating the possessor as part of the ARG-ST of the picture noun comes from the interpretation of reflexives in PNPs under ellipsis. Ellipsis is a useful tool since it can be used to reveal meaning differences between bound variable and coreferential construals. Before turning to the crucial examples, it is worth noting that, as many researchers have observed (e.g., Grodzinsky & Reinhart 1993), pronouns elided via VP-ellipsis can be interpreted in two ways. Consider (14).

- (14) a. John thinks that he is a good cook, and Fred does, too.  
 b. John thinks that he is a good cook, and Fred thinks that Fred is a good cook, too. [Bound variable reading]  
 c. John thinks that he is a good cook, and Fred thinks that John is a good cook, too. [Coreferential reading]

The sentence in (14a) containing the elided VP can be interpreted as either (14b) or (c). The crucial difference is the source of the antecedent for the elided pronoun. In the (14b) the pronoun is interpreted as if bound by the local antecedent (Fred), for the “bound variable” (BV) interpretation. In the (14c) interpretation, the pronoun is interpreted as coreferring with the subject of a sentence prior in the discourse (John), for the “coreferential” (Coref) interpretation.

Kiparsky (2002), building on Hestvik (1990), argues that a bound variable reading is obligatory when a reflexive is bound by a co-argument, but not when it is bound by a non-co-argument. He provides (15a) and (16a) as evidence.

- (15) a. John hates himself, and so does Fred.  
 b. John hates himself, and Fred hates himself (=Fred). [BV]  
 c. \*John hates himself, and Fred hates John. [Coref]

- (16) a. John has a picture of himself, and so does Fred.  
 b. John has a picture of himself, and Fred has a picture of himself (=Fred). [BV]  
 c. John has a picture of himself, and Fred has a picture of John. [Coref]

The sentence with the elided VP in (15) can be interpreted only as ‘Fred hates himself’, not as ‘Fred hates John’; thus the elided reflexive behaves as a bound variable only. In contrast, the possessorless PNP example with the elided VP in (16) allows both interpretations (Kiparsky 2002, Grodzinsky & Reinhart 1993). It can be interpreted as either ‘Fred has a picture of himself’ (bound variable) or ‘Fred has a picture of John’ (coreferential). In (15) the elided reflexive and its antecedent are co-arguments, but in (16) they are not. Thus, the coreferential reading is available only when the anaphor is bound by a non-co-argument, but the bound variable reading is available in both co-argument and non-co-argument binding configurations. The Pollard & Sag approach correctly predicts the availability of both interpretations for reflexives in PNP, since they treat these reflexives as exempt anaphors: the reflexive in (16) is not bound by a co-argument, and thus allows a coreferential interpretation.

We use the correlation between non-co-argumenthood and coreferential readings to probe the status of the possessor in possessed PNPs. If the possessor in a PNP is a co-argument of the postnominal phrase, then only a bound variable interpretation should be available to an elided reflexive in the post-nominal position. Runner, Sussman & Tanenhaus (2002) provide the example in (17b), and suggest that, in the appropriate contexts, such as that provided by (17a), both the coreferential and bound variable interpretations are available.

- (17) a. Context: The Kennedy mansion is having an estate sale. For sale are the personal photos and prints of the members of the Kennedy family. Since these items actually belonged to the Kennedys the prices were very high. A museum down the street, due to budget cuts, was going out of business and had to sell all of their photos, including their extensive collection of Kennedy prints. My friend Jimmy had always liked a particular photo of JFK and was pleased to find the one that JFK had owned at the Kennedy estate sale. He didn't know that the same print was available at the museum sale or he would've bought that one since he is on a tight budget.  
 b. Jimmy bought JFK's picture of himself for \$500 not realizing he could've bought the museum's for just \$100 in its going out of business sale.

In this context the coreferential interpretation of the elided reflexive is the strongly preferred reading. The elided NP is interpreted as ‘the museum's



picture of JFK', i.e. interpreted coreferentially, which suggests that it is not a co-argument of the possessor.

Furthermore, Runner, Sussman & Tanenhaus (to appear) discusses the results of an experimental investigation of bound variable and coreferential readings in PNPs, and reports that indeed coreferential interpretations are available to elided reflexives in PNPs containing possessors. Participants were seated in front of a set of dolls and a display containing pictures of these dolls (see Figure 1). They followed sequences of instructions such as (18). The material in angled brackets was present on half of the trials (see Runner et al. to appear for details). The reflexive was interpreted coreferentially—as referring to Harry's picture of Ken—more frequently when elided than when not.

- (18) Pick up Joe. Have Joe touch Ken's picture of himself. Now, have Joe touch Harry's <picture of himself>.



Figure 1. Runner et al. (to appear) display.

The availability of a coreferential interpretation under ellipsis in examples like (18) and (17b) provides our first argument against treating the possessor as part of the ARG-ST of the picture noun.

## 2.2 Reflexive Interpretations: 'Only'

Our second argument against treating the possessor as a co-argument of the postnominal phrase comes from the interpretation of 'only' constructions and builds on the claim that reflexives must be interpreted as bound variables if bound by a co-argument. Consider, for example, example (19), taken from Runner et al. (2002).

(19) Jimmy really wanted to see only Madonna's picture of herself.

The reflexive in this sentence can receive a coreferential interpretation in the appropriate context, such as one in which a photography gallery has assembled many photos of Madonna, including one that Madonna shot of herself. The coreferential interpretation is one where Jimmy wants to see that picture of Madonna and not any of the other pictures of Madonna. In contrast, a bound variable reading would be one where Jimmy wants to see a self-portrait of Madonna owned by Madonna and nobody else's self-portrait. In light of Kiparsky's observation regarding coreferential readings and non-co-argument binders (see Section 2.1), the availability of the coreferential interpretation in (19) provides further evidence against treating the possessor as part of the ARG-ST of the picture noun.

### 2.3 Collective and Distributive Pronoun Interpretations

The first two arguments against treating the possessor of the PNP as a co-argument of the postnominal phrase come from the interpretation of postnominal reflexives. Our third argument is based on the interpretation of postnominal pronouns. This argument is also taken from Kiparsky's (2002) discussion. Following Reinhart & Reuland (1993), he notes that co-arguments and non-co-arguments pattern differently with respect to collective vs. distributive readings. Examples such as (20), with co-argument binding, are acceptable but only on a collective interpretation; a distributed interpretation seems to be blocked. However, in the case of the binding of non-co-arguments as in (21), the distributed interpretation is also available.

(20) By an overwhelming majority, we preferred me.

(21) John and Mary both have a picture of him.

Kiparsky argues that the referent of plural expression *we* in (20) must act as a single collective entity and not as separate individuals. For example, (20) is true in a context where the preference is established by voting, even if there exists a small number of individuals who did not vote for the referent of *me*. However, it cannot be interpreted distributively, which would be the case if each individual just happened to prefer the referent of 'me' but not as a group per se. In contrast, the plural expression in (21), *him*, can be interpreted both collectively and distributively. For example, the collective interpretation would be true in a context where John and Mary own one picture together; but crucially a second distributive interpretation is available. In that case (21) would be true in a context where each person has a separate picture of John. The availability of both readings means, according to Kiparsky's approach,

that this is a case of non-co-argument binding—in other words, that the reflexive in (21) is an exempt anaphor as defined by Pollard and Sag.

Similar examples probing the distributive/collective distinction can be constructed with PNPs containing a possessor. If the possessor is a co-argument, the distributive reading should be excluded. This does not seem to be the case:

- (22) John prefers our pictures of me.  
(23) I prefer John and Mary's pictures of him.

Here it is possible to interpret the plural possessor as individuals. For example, (22) would be true in a situation in which either we as a group have pictures of me, or we as individuals have (possibly separate) pictures of me. And (23) would be true even in a situation where there are no pictures of John owned by both John and Mary, as long as John and Mary both separately own pictures of John. We follow Kiparsky in interpreting the availability of the distributive reading as an indication that the possessor and the postnominal pronoun are non-co-arguments.

This section, then, has provided three arguments against treating the postnominal NP in a picture NP containing a possessor phrase as a co-argument with the possessor phrase. The first two arguments were built on claims about differences in interpretations of reflexives that do and do not have co-argument antecedents; postnominal PNP reflexives behaved as if the possessor phrase were not a co-argument. The third argument built on the claim that pronoun interpretation depends on the co-argument status of the antecedent. Again, the postnominal PNP pronoun behaved as if the possessor phrase were not a co-argument.

In sum, these three arguments suggest that the possessor is not on the ARG-ST of the picture noun. If we remove the possessor from the ARG-ST of the picture noun, we can now begin to analyze examples such as (7), repeated here as (24):

- (24) Ebenezer<sub>i</sub> saw Jacob<sub>j</sub>'s picture of himself<sub>j/i</sub>.

If 'Jacob' is not a co-argument of 'himself', 'himself' is an exempt anaphor and is free to take either 'Jacob' or 'Ebenezer' as antecedent. As mentioned earlier, the choice is presumably modulated by the discourse constraints on exempt anaphors. We acknowledge that for this account to be tenable, such a modulation needs to be demonstrated, and is an important question for future work.

### 3 Reflexives in PNPs as ‘Exempt’ Anaphors

The previous section provided evidence against treating the possessor in a PNP and a post-nominal reflexive as co-arguments. It follows, then, that this reflexive is a Binding Theory-exempt anaphor, since it has no o-commanding co-arguments.

Pollard and Sag claim that, unlike other reflexives, the distribution of exempt anaphors is not determined by the structural constraints of the Binding Theory, but by semantic, pragmatic and discourse factors. Little is known about the full range of these factors, though several likely candidates have been observed. As pointed out above, perspective can play a role in licensing these reflexives; see e.g., (12) and (13), repeated here as (25) and (26).

- (25) John<sub>i</sub> was going to get even with Mary. That picture of himself<sub>i</sub> in the paper would really annoy her, as would the other stunts he had planned.
- (26) Mary was quite taken aback by the publicity John<sub>i</sub> was receiving. \*That picture of himself<sub>i</sub> in the paper would really annoy her, as would the other stunts he had planned.

As we pointed out above, no obvious structural explanation will account for the acceptability of (25) and the contrast with (26). In this section we discuss experimental work that has been designed to explore some of the discourse/semantic factors that affect the interpretation of PNP reflexives, beginning with reflexives in PNPs lacking a possessor phrase and then turning to a study of PNPs with a possessor phrase. Overall, we will see that reflexives in PNPs do appear to be sensitive to non-structural factors. We take this as supporting evidence for the proposal we developed above, that reflexives in PNPs are exempt anaphors, even when appearing in PNPs containing a possessor phrase.

Kaiser, Runner, Sussman & Tanenhaus (in press), developing Kuno’s (1987) and Sells’ (1987) proposals, have experimentally investigated the role of the notion of “source of information” in licensing reflexives in PNPs. In one experiment, participants had to indicate whether a particular sentence matched the scene shown on a computer monitor (see Figure 2). Sentences such as (27), with either *tell* or *hear*, were used. With *tell*, the subject of the sentence is the “source of information”, but with *hear*, the object is the source.

- (27) Peter {told/heard from} Andrew about the picture of himself on the wall.

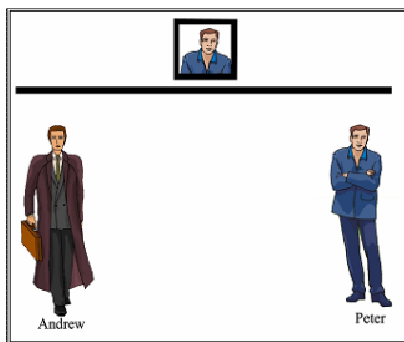

Figure 2

The results show that though participants had an overall preference for the subject NP as the antecedent of the reflexive, there was still a small effect of verb type. Participants were more likely to accept the object as antecedent of the reflexive if the object was the source of information.

In a second experiment, using eye-tracking methodology, participants had to click on the appropriate picture mentioned in sentences such as (27), above (see Figure 3).

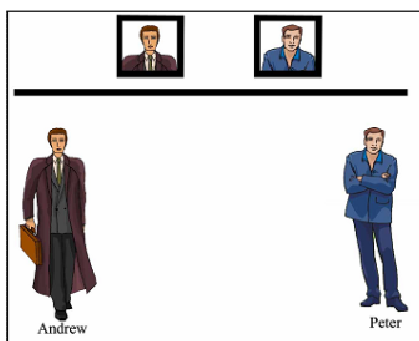

Figure 3

Again, target choices indicate a general subject preference, but there was also a small numerical effect showing that if the object is the source, participants are somewhat more likely to choose it as antecedent than if it is not the source. Furthermore, in addition to the picture choice data, participants' eye-movements show that they were more likely to consider the possibility of the object as antecedent if it was also the source of information. If sensitivity to source is characteristic of exempt anaphors, these findings provide evidence in favor of analyzing PNP reflexives as exempt.

Having considered PNPs lacking a possessor phrase, let us now consider the effects of non-structural factors in PNPs *with* possessors. The first argument in favor of treating reflexives in PNPs with possessors as susceptible to non-structural factors (and hence as exempt anaphors) comes from examples NP ellipsis examples such as (17b) and (18), repeated here as (28) and (29).

- (28) Jimmy bought JFK's picture of himself for \$500 not realizing he could've bought the museum's for just \$100 in its going out of business sale.
- (29) Pick up Joe. Have Joe touch Ken's picture of himself. Now, have Joe touch Harry's.

Though these examples have already been discussed above in the context of an argument against treating the possessor and the postnominal reflexive as co-arguments, it is important to note that the exempt anaphor analysis of PNP reflexives makes another claim as well—namely that these reflexives can receive coreferential interpretations, and in particular can receive their interpretation from something in the discourse context. This claim, which comes from the Pollard & Sag treatment of exempt anaphors, helps explain the Kiparsky observation that reflexives related to a non-co-argument antecedent can be interpreted coreferentially. Examples (28) and (29) illustrate this clearly since in both cases the interpretation of the elided reflexive comes from the discourse. Even if the elided NP is literally reconstructed, the reference of the elided reflexive comes from the antecedent NP's possessor. In other words, the ability of these reflexives to receive a coreferential interpretation directly rests on the claim that they are sensitive to discourse rather than structure (alone).

A second argument in favor of treating reflexives in PNPs with possessors as exempt comes from data presented in Jaeger (2004). Jaeger manipulated the semantic roles of the possessor and the subject such that sometimes the subject was a so-called "salient creator" of the PNP, and sometimes the possessor was the salient creator. Our understanding of 'salient creator' is that it refers to a well-known artist/photographer. In (30), the famous photographer Manray—the salient creator—is the subject, and in (31) it is the possessor:

- (30) Manray burned Mary's photo of himself.
- (31) Mary burned Manray's photo of herself.

In Jaeger's materials, the reflexive was always bound by the subject. His magnitude estimation experiments show that participants' ratings indicated that they preferred (30) to (31). In other words, given that the reflexive is bound by the subject, participants prefer sentences where the subject is also

the salient creator over sentences where the possessor is the salient creator. We take this to suggest that participants would have preferred the salient creator possessor as antecedent in (30), and that the notion of “salient creator” is relevant to the choice of antecedent for these reflexives. Thus, the non-structural factor “salient creator”, like “source”, seems to be relevant to the licensing of exempt anaphors. And the fact that reflexives in PNPs containing possessors show sensitivity to such factors supports our view of treating them as exempt anaphors.

#### 4 Implications for Binding Theory

Section 2 provided three arguments against treating the possessor and postnominal phrase as co-arguments. We interpret this as showing that the possessor itself is not part of the argument structure (ARG-ST) of the picture noun. However, if the possessor is not part of the ARG-ST of the head noun, then how is it associated with the PNP? In addition, how can we account for the disjoint reference between the possessor and a pronoun in the PNP? Here, we outline a promising analysis of the relationship between the possessor and the head picture noun, and develop a modified version of Binding Theory which accounts for the disjoint reference.

In recent work on wh-extraction within HPSG, Bouma, Malouf & Sag (2001) argue that, in order for a lexicalist approach to wh-extraction to succeed, there must exist a level of representation containing the head as well as information about all of its “dependents”, including those listed in the ARG-ST as well as those more loosely related to the head, such as adverbials and adjuncts of various sorts. They name this dependents structure (DEPS). The main motivation for this structure comes from extraction involving adjuncts and other phrases that do not appear on a verb’s ARG-ST (see Bouma et al. 2001 for details).

As pointed out above, analyzing the possessor phrase as not part of the ARG-ST of the picture noun allows a straightforward account of the reflexive data. However, this proposal does not immediately explain the pronoun data discussed in Section 1. The pattern in (8), repeated here as (32), suggests that a disjointness constraint needs to be enforced at some level of representation containing both the pronoun and the possessor of the PNP.

(32) Ebenezer<sub>i</sub> saw Jacob<sub>j</sub>’s picture of him<sub>i/k/\*j</sub>.

We argued above that the possessor is not associated with the head via ARG-ST, and in this section we pursue the possibility that the association takes place on the level of the DEPS structure instead. This would make DEPS a representation that contains both the possessor and the pronoun inside the PNP – in other words, precisely a level at which we can state the disjointness

constraint for pronouns. To implement this, we suggest that the Binding Theory should apply to DEPS structure rather than on ARG-ST:

(33) Binding Conditions

Principle A. A locally a-commanded reflexive must be locally d-bound.

Principle B. A pronoun must not be locally d-bound.

Principle C. A non-pronoun must not be d-bound.

D-binding is identical to a-binding, with the distinction that it applies on the DEPS list. Importantly, Principle A still refers to a locally a-commanded reflexive in its definition of which reflexives are so constrained. The intuition is that co-argumenthood is what is relevant for defining reflexives as either constrained or exempt from Binding Theory. However, it is “co-dependence” that is relevant to the disjointness requirement for pronouns.

To illustrate this account, let’s consider again the following examples in (34a) and (b) and the ARG-ST and DEPS lists for the head noun ‘picture’ in (c) and (d):

- (34) a. Ebenezer<sub>i</sub> saw Jacob<sub>j</sub>’s picture of himself<sub>i/j/\*k</sub>.  
 b. Ebenezer<sub>i</sub> saw Jacob<sub>j</sub>’s picture of him<sub>i/k/\*j</sub>.  
 c. ARG-ST <NP>  
 d. DEPS <NP<sub>j</sub>, NP>

The reflexive in (a) and the pronoun in (b) will appear alone on their ARG-ST list, as in (c). As such, the reflexive will not come under the purview of the Binding Theory because it is not locally a-commanded; thus it will be an exempt anaphor. The reflexive and pronoun will both appear on a DEPS list with the possessor phrase (Jacob<sub>j</sub>), as in (d). Principle B will require, then, that the pronoun be disjoint from the possessor (not be locally d-bound).

In most cases, this version of Binding Theory will overlap with one based solely on ARG-ST. However, there are some cases where these two approaches differ. For example, as just illustrated, for PNPs with possessors our version of Binding Theory correctly places PNP reflexives outside the control of Binding Theory, and keeps PNP pronouns within Binding Theory. Another case where the Binding Theory based on DEPS does not overlap with that based on ARG-ST comes from well-known Principle C violations involving non-pronouns in adjoined phrases.

- (35) Mary<sub>i</sub> is tired. She<sub>i</sub> had to prepare dinner for Betsy when she<sub>i/\*Mary<sub>i</sub></sub> got home.

The ‘when’ clause is not associated with the ARG-ST of the head verb ‘prepare’ and thus the standard version of ARG-ST-based Binding Theory



cannot rule out the use of the non-pronoun here. On the assumption that Principle C is relevant to the binding in examples like (32), the version based on DEPS correctly accounts for it.<sup>1</sup>

To summarize, redefining Binding Theory on the DEPS list provides a straightforward analysis of the pronoun data in possessed picture NPs while also allowing reflexives in the same construction to be exempt anaphors. In the next section we briefly discuss the merits of and potential challenges for two alternative approaches to accounting for the data illustrated in (34).

## 5 Alternatives

### 5.1 Eliminating DEPS

During the Binding Theory Workshop at which this paper was originally presented, Ivan Sag proposed an alternative analysis of the basic data treated in this paper. His proposal allowed the Binding Theory to remain defined on ARG-ST (as opposed to DEPS). Consider again the examples from (34):

- (36) a. Ebenezer<sub>i</sub> saw Jacob<sub>j</sub>'s picture of himself<sub>i/j/\*k</sub>.  
 b. Ebenezer<sub>i</sub> saw Jacob<sub>j</sub>'s picture of him<sub>i/k/\*j</sub>.

The goal of Sag's alternative analysis is a way to define the Binding Theory so that the reflexive in (36a) is exempt, while the pronoun in (36b) is not. The intuition behind the proposal is that while ARG-ST is relevant for the Binding Theory, the notion of exemption is defined with reference to valence features, namely "subject" (SUBJ). The possessor of the PNP would not be a SUBJ, but would presumably bear some other valence feature. The relevant definitions are listed in (37) and (38).

- (37) a-command (same)  
 s-command: A s-commands B if A a-commands b and A is also a SUBJ

---

<sup>1</sup> One place where the DEPS approach appears not to make the correct predictions is the raising to object construction. It is usually assumed that in (i) the reflexive is a co-argument with the subject; however, under ellipsis a coreferential interpretation seems to be available, as in (ii), from Kiparsky 2002.

- (i) John considers himself competent.  
 (ii) John considers himself competent, and so does Fred.

We do not yet have a complete analysis of these facts, but we recognize that they point to there being a difference between a true object and a raised object with respect to their relationship with the verb's subject. We leave open whether this difference is a matter of ARG-ST or DEPS or some other feature.

- (38) Principle A: a locally s-commanded anaphor must be locally a-bound.  
Principle B: a pronoun must be locally a-free.

To illustrate this account, we compare the analysis of (36a) and (b), and (38), which involves a BT-constrained reflexive.

- (38) Jacob photographed himself.

The relevant parts of the representations are in (39). (39a) is the representation for the picture NPs in (36), and (39b) is for the sentence in (38):

- (39) a. NP1's picture of NP2: [ARG-ST <NP1, NP2>, SUBJ <>]  
b. NP1 photographed NP2: [ARG-ST <[1]NP1, NP2>, SUBJ <[1]>]

Since NP1 in (39a) is not a SUBJ, NP2 can be an exempt anaphor. A pronominal NP2 in (39a), however, will be required to be disjoint from NP1, as desired. Since NP1 in (39b) is a SUBJ, if NP2 is a reflexive, it will be constrained by Principle A, and be restricted to being coindexed with NP1.

Though this alternative does correctly predict the data in (36) and (38), it does not immediately have an explanation for the data patterns we discussed in Section 2, i.e., the bound variable/coreference and distributive/collective data which suggest that the possessor and the postnominal phrase (reflexive or pronoun) are not co-arguments. Sag's alternative approach still places both phrases on the ARG-ST list of the head noun 'picture'.

## 5.2 Eliminating (obligatory) Principle A

Pollard (this volume) presents a modified version of our DEPS proposal. He follows our proposal in treating possessive determiners as dependents (not valents) which locally d-command (not o/a-command) PP complements of N. In addition, though, his proposal also allows for any reflexive in principle to be treated as an "exempt" anaphor. The relevant definitions are in (40).

- (40) Principle R': Every r-pronoun is either  
a. coindexed with a local d-commander, or  
b. interpreted according to certain pragmatic constraints involving logophoricity, contrastiveness, or discourse prominence.

Pollard makes clear that at this stage (40) is only a hypothesis, and whether it will turn to be correct is an empirical question. In particular, he provides an array of examples in which the range of binding possibilities is not entirely

clear. Whether an obligatory Principle A can truly be eliminated from the Binding Theory (as in (40)), then, is an empirical question.

One observation, though, is that if the contrasts we provided in Section 2, which are meant to distinguish between co-arguments and non-co-arguments, are on the right track, then it seems that an obligatory Principle A-type constraint could provide the basis for an account of the obligatory bound variable interpretations discussed in Section 2. That is, when an object reflexive takes the subject of the sentence as its antecedent, only a bound variable interpretation is available. This can be explained if it is precisely in that structural context (when the reflexive is locally a-commanded) that the reflexive must be coindexed with a locally a-commanding NP—that is, be bound by it. If a-binding is a subtype of variable binding, then the bound variable restriction is immediately accounted for.

## 6 Conclusion

Previous experimental data suggested that a reflexive need not be bound by the possessor in a possessed PNP but that a pronoun must be disjoint from the possessor. In this paper, we argued that the possessor and the postnominal phrase are not co-arguments and that the postnominal reflexive is an exempt anaphor. We presented a possible redefinition of Binding Theory on the level of DEPS structure, which allows us to capture the intuition co-argumenthood is relevant to determining whether a reflexive is ‘exempt’ or not, and that co-dependence is relevant to (non)pronoun disjointness. In future work, we hope to investigate the feasibility and potential wider implications of this approach in more depth, especially in comparison to the alternative approaches put forth by Sag and Pollard.

## References

- Asudeh, Ash and Frank Keller. (2001). Experimental Evidence for a Predication-based Binding Theory. In Mary Andronis, Christopher Ball, Heidi Elston, and Sylvain Neuvel, eds., *Papers from the 37th Meeting of the Chicago Linguistic Society. Vol. 1: The Main Session*, 1-14. Chicago.
- Bouma, G., R. Malouf, & I. Sag. (2001). Satisfying Constraints on Extraction and Adjunction, *Natural Language and Linguistic Theory* 19, 1-65.
- Chomsky, N. (1981). *Lectures on Government and Binding*. Dordrecht: Foris.
- Chomsky, N. (1986). *Knowledge of language*. New York: Praeger.
- Grodzinsky, Y. & Reinhart, T. (1993). The innateness of binding and coreference. *Linguistic Inquiry*, 24, 69-101.
- Hestvik, A. (1995). Reflexives and Ellipsis. *Natural Language Semantics* 3:211-237.
- Hobbs, J.R. (1978). Resolving Pronoun References. *Lingua*, 44, 311-338.
- Jaeger, T.F. (2004). Binding in picture NPs revisited: Evidence for a semantic principle of extended argument-hood. In M. Butt & T.H. King (eds.) *Proceedings of the LFG04 Conference*, Christchurch, New Zealand. Stanford: CSLI Publications.
- Kaiser, E., Runner, J.T., Sussman, R.S. & Tanenhaus, M.K. (in press). The interpretation of pronouns and reflexives in picture noun phrases: effects of non-structural factors. To appear in A. Alcazar, R. Mayoral Hernandez and M. Temkin Martinez (eds.), *Proceedings of the Western Conference on Linguistics 2004*. Fresno, CA: California State University at Fresno.
- Keller, F. & A. Asudeh. (2001). Constraints on Linguistic Coreference: Structural vs. Pragmatic Factors. In Johanna D. Moore and Keith Stenning, eds., *Proceedings of the 23rd Annual Conference of the Cognitive Science Society*, 483-488. Mahwah, NJ: Lawrence Erlbaum.
- Kiparsky, P. (2002). Disjoint Reference and the Typology of Pronouns. In Ingrid Kaufmann and Barbara Stiebels (eds.), *More than Words*. *Studia Grammatica* 53, pp. 179-226. Berlin: Akademie Verlag.
- Kuno, S. (1987). *Functional Syntax: Anaphora, discourse and empathy*. Chicago: University of Chicago Press.
- Manning, C. and I. Sag. (1999). Dissociations between Argument Structure and Grammatical Relations. In G. Webelhuth, J.-P. Koenig, and A. Kathol (eds.), *Lexical and Constructional Aspects of Linguistic Explanation*. Stanford: CSLI Publications.
- Pollard, C. (This volume). What are binding principles constraints on?
- Pollard, C. & Sag, I. (1992). Anaphors in English and the scope of Binding Theory. *Linguistic Inquiry*, 23, 261-303.
- Pollard, C. & Sag, I. (1994). *Head-driven Phrase Structure Grammar*. Chicago: CSLI/University of Chicago Press.

- Reinhart, T. & Reuland, E. (1993). Reflexivity. *Linguistic Inquiry*, 24, 657-720.
- Runner, J.T., Sussman, R.S. & Tanenhaus, M. K. (2002). Logophors in possessed picture noun phrases. In L. Mikkelsen & C. Potts, (Eds.) *WCCFL 21 Proceedings*, 401-414. Somerville, MA: Cascadilla Press.
- Runner, J.T., R.S. Sussman, & M.K. Tanenhaus. (2003). Assignment of Reference to Reflexives and Pronouns in Picture Noun Phrases: Evidence from Eye Movements, *Cognition* 89, B1-B13.
- Runner, J.T., R.S. Sussman, & M.K. Tanenhaus. (To appear). Processing Reflexives and Pronouns in Picture Noun Phrases, *Cognitive Science*.
- Sells, P. (1987). Aspects of Logophoricity. *Linguistic Inquiry* 18 (3):445-479.

# Verifying binding constraints for anaphor resolution

Roland Stuckardt

Johann Wolfgang Goethe University Frankfurt am Main

Proceedings of the 12th International Conference on  
Head-Driven Phrase Structure Grammar

Department of Informatics, University of Lisbon

Stefan Müller (Editor)

2005

Stanford, CA: CSLI Publications

pages 614–634

Stuckardt, Roland. 2005. Verifying binding constraints for anaphor resolution. In Stefan Müller (ed.), *Proceedings of the 12th International Conference on Head-Driven Phrase Structure Grammar, Department of Informatics, University of Lisbon*, 614–634. Stanford, CA: CSLI Publications. DOI: 10.21248/hpsg.2005.35.



## Abstract

Algorithmic approaches to anaphor resolution are known to benefit substantially from syntactic disjoint reference filters. Typically, however, there is a considerable gap between the scope of the formal model of grammar employed for deriving referential evidence and its implementation. While accounting for many subtleties of language, such formal models at most partially address the algorithmic aspects of referential processing. This paper investigates the issue of implementing syntactic disjoint reference for robust anaphor resolution. An algorithmic account of binding condition verification will be developed that, on one hand, captures the theoretical subtleties, and, on the other hand, exhibits computational efficiency and fulfils the robustness requirements. Taking as input the potentially fragmentary parses of a robust state-of-the-art parser, the practical performance of this algorithm will be evaluated with respect to the task of anaphor resolution and shown to be nearly optimal.

## 1 Introduction

Syntactic disjoint reference rules are known to be of paramount importance to robust, algorithmic<sup>1</sup> anaphor resolution. Starting with the pioneering paper of Hobbs (1978), a plethora of algorithms has been developed that exploits this source of evidence as a filter for narrowing down sets of antecedent candidates for anaphoric expressions. Among this work are the landmark approach of Lappin and Leass (1994) and its numerous robust, knowledge-poor descendants, e. g. Kennedy and Boguraev (1996); Mitkov (1998); Stuckardt (2001). These approaches employ syntactic disjoint reference rules that capture referential evidence derived from formal models of grammar such as Government and Binding (GB) Theory (Chomsky (1981)) to the extent that it is deemed relevant to accomplish the task of anaphor resolution.

In general, there is a considerable gap between the scope of the formal model and its algorithmic implementation. In dealing with issues well beyond anaphora and in claiming cross-linguistic generality, GB theory refers to complex descriptions of syntactic surface structure that, today as well as in the near future, no robust parser can be expected to construct automatically. Thus, while accounting for many subtleties of language, such formal models at most partially address the *algorithmic* aspects of referential processing that are relevant for practical tasks of referential disambiguation.

Nevertheless, robust anaphor resolution approaches require implementations of syntactic disjoint reference that gather as much evidence as possible. This paper investigates the issue of implementing syntactic disjoint reference for robust anaphor resolution. An algorithmic account of binding condition (BC) verification will be

---

<sup>1</sup>The adjectives *robust* and *algorithmic* are conceived as synonyms here. Henceforth, they are employed interchangeably for qualifying approaches to anaphor resolution that are fully implemented and work without human intervention. Equally well one might speak of *operational* or *practical* anaphor resolution.

developed that, on one hand, captures the theoretical subtleties, and, on the other hand, exhibits computational efficiency and fulfils the robustness requirements.

The paper is organized as follows. Section 2 recapitulates the formal notions of Chomsky’s GB theory to the extent relevant to the subsequent discussion. In particular, a number of central issues regarding the GB predictions on coreference are identified that, while being important for accomplishing the task of anaphor resolution, are neglected by many algorithmic accounts of binding. In section 3, starting with an identification of the scope of Chomsky’s original algorithm for determining admissible index assignments, different algorithmic approaches to binding condition verification are put under scrutiny. Limitations are identified that render these approaches insufficient. In section 4, departing from a closer analysis of the robustness requirements in the context of state-of-the-art parsers that yield fragmentary output, an algorithmic account of binding is developed that fulfils the theoretical and practical requirements and that can thus be employed as part of a robust rule-based anaphor resolution algorithm. An implementation and evaluation with respect to the task of robust anaphor resolution on fragmentary parses gives evidence that the binding condition verification algorithm performs nearly optimal.

## 2 A Formal Model of Syntactic Disjoint Reference

### 2.1 GB Theory

By referring to the Government and Binding Theory of Chomsky, the core of the syntactic coindexing restrictions may be stated as follows (Chomsky (1981)):<sup>2</sup>

#### Definition

#### Binding Principles A, B, and C:<sup>3</sup>

- (A) A reflexive or reciprocal is bound in its binding category.
- (B) A pronoun is free (i.e. not bound) in its binding category.
- (C) A referring expression<sup>4</sup> is free in any domain.

where **binding category** denotes the next surface-structural dominator containing some kind of subject, and **binding** is defined as *coindexed and c-commanding*:

#### Definition

Surface structure node X **c-commands** node Y if and only if the next branching node which dominates X also dominates Y and it is not the case that X dominates Y, Y dominates X, or X = Y.

---

<sup>2</sup>Various theoretical models that cover disjoint reference phenomena have been stated. Since the disjoint reference conditions are descriptive principles of grammar, the choice of the theoretical model is, in this sense, arbitrary. In the subsequent discussion, the comprehensive and widely known GB theory is explicated. Equally well one might refer to the approach to binding theory proposed by Pollard and Sag (1994).

<sup>3</sup>For languages such as Portuguese, a fourth binding principle (Z, not covered by original BT) might be distinguished, which accounts for cases of *long-distance reflexives*.

<sup>4</sup>e.g. common nouns and names



Some examples which illustrate the scope of the binding principles are

- (1a) *The barber<sub>i</sub> is shaving himself<sub>i</sub> / \*him<sub>i</sub>.*
- (1b) *The client<sub>i</sub> wants that the barber<sub>j</sub> shaves \*himself<sub>i</sub> / him<sub>i</sub>.*
- (1c) *\* The client<sub>i</sub> wants that the barber<sub>j</sub> shaves the client<sub>i</sub>.*

In sentence (1a), whereas the reflexive *himself* is required to be coindexed with the local subject *the barber* (BP A), coindexing the pronoun *him* with the subject is ruled out (BP B) because, otherwise, the pronoun would be locally bound in its binding category. Sentence (1b) illustrates the case of non-local binding (here: outside the embedded sentence) which is admissible only for the non-reflexive pronoun. As illustrated by sentence (1c) and modeled by BP C, referring expressions (e.g. common nouns and names) are not even allowed to be bound non-locally.

A further structural well-formedness restriction, commonly named **i-within-i condition**, aims at ruling out certain instances of referential circularity, i.e. coindexings matching the pattern  $[\alpha \dots [\beta \dots ]_i]_i$  (Chomsky, 1981, page 212). It is motivated by cases like

- (2) *\* Mary knows [ the owner of his<sub>i</sub> boat ]<sub>i</sub>.*

## 2.2 GB predictions for anaphora processing: a closer look

In order to adequately operationalize the binding conditions for the task of anaphora processing, the implementation has to take into account some subtleties that are not adequately captured by algorithms described in previous work.

### 2.2.1 Taking into account the binding condition of the antecedent

Considering the issue of binding from the perspective of the algorithmical task of anaphor resolution, which is typically conceived as the problem of determining admissible antecedent candidates for anaphors, one might be tempted to interpret the predictions of binding theory *asymmetrically*. Regarding nonreflexive pronouns, for instance, antecedent candidates are sought for that do not locally bind the pronoun, for which BP B applies. However, since coindexing is a symmetrical relation, one has to take into account the BP of the antecedent candidate as well. E. g., in

- (3) *\* He<sub>i</sub> is shaving the client<sub>i</sub>.*

while the binding constraint of *he* is satisfied, coindexing this pronoun with the NP *the client* (which might be conceived as antecedent candidate during anaphor resolution) is nevertheless inadmissible as BP C of the NP would be violated.<sup>5</sup>

<sup>5</sup>This elementary example, which shows an instance of backward anaphora, has been chosen for reason of expository simplicity. There are as well cases of forward anaphora in which this issue is important.

### 2.2.2 Accounting for decision interdependency

More importantly, however, but nevertheless not covered by many algorithmic approaches to binding, the *transitivity* of the coindexing relation should be taken into account. Here, the misconception consists in identifying the task of determining admissible index assignments with the task of determining sets of (isolated) pairs  $(\alpha, \gamma)$  of anaphors  $\alpha$  and antecedents  $\gamma$  to be coindexed. However, as illustrated by the following example, this falls short of avoiding transitive violations of the binding constraints:

(4) \* *The architect<sub>i</sub> promises that he<sub>i</sub> is going to support him<sub>i</sub>.*

While, *individually*, it is admissible to coindex the type C NP *The architect* with either of the type B pronouns *he* and *him*, taken together, these anaphor resolution decisions violate the binding condition of *him* as it becomes transitively coindexed with the locally c-commanding occurrence *he*.<sup>6</sup>

### 2.2.3 Strong vs. weak application of BP A

While it is important to take into account the binding conditions of anaphor *and* antecedent candidate and to provide a mechanism for avoiding mutually incompatible individual decisions  $(\alpha, \gamma)$ , care should be taken not to over-interpret the requirements for reflexive and reciprocal pronouns, as the applicable BP A merely demands the existence of *one* locally c-commanding binder, but doesn't preclude the existence of further coindexed occurrences, as illustrated by

(5) *The barber<sub>i</sub> admits that he<sub>i</sub> shaves himself<sub>i</sub>.*

This *weak* (henceforth also called *non-constructive*) interpretation of BP A should be applied whenever checking for decision interdependency or when considering type A pronouns as antecedent candidates. This will become more clear in section 4.4 where the algorithmic verification of the binding conditions is integrated into a robust anaphor resolution algorithm.

### 2.2.4 Non-finite local domains of binding

Binding categories are not exclusively contributed by finite clauses. There are other syntactic configurations that match the definition given in section 2.1. In particular, the various types of possessive markers, such as possessive pronouns, are considered to constitute *logical subjects* in the sense of the GB theory, thus inducing local domains as well. The following examples illustrate that, if one thus considers NPs modified by a possessor as binding categories, binding principles A and B yield the right predictions, as the NP-local binding of reflexive pronouns is enforced, and the NP-local binding of non-reflexive pronouns is ruled out:

<sup>6</sup>Cases of decision interdependency can even be the consequence of choosing an identical *intersentential* antecedent for pronouns occurring in the same local domain of binding. In this sense, the predictions of BT might have repercussions for instances of intersentential anaphora.

- (6a) *The barber<sub>i</sub> hears [ Peter's<sub>j</sub> story about himself<sub>j</sub> ].*  
 (6b) \* *The barber<sub>i</sub> hears [ Peter's<sub>j</sub> story about himself<sub>i</sub> ].*  
 (6c) \* *The barber<sub>i</sub> hears [ Peter's<sub>j</sub> story about him<sub>j</sub> ].*  
 (6d) *The barber<sub>i</sub> hears [ Peter's<sub>j</sub> story about him<sub>i</sub> ].*

Hence, an appropriate implementation of the binding condition verification should cover these - and other <sup>7</sup> cases, as well.

### 2.2.5 Empty categories

An even more intricate, but (as will become evident during the subsequent discussion) technically related issue is the proper treatment of *empty categories*, which are known to play a central role for the modeling of binding phenomena in GB theory. Empty categories might be characterized as *implicit* occurrences (index bearers), i. e. surface-structural entities for which no immediate counterpart at the level of linguistic expressions exist. Corresponding to the different ways of binding-theoretical treatment, several types of empty categories are distinguished.

**Traces** are employed for modeling instances of transformation (Move- $\alpha$ ) in the theoretical mapping process between deep structure and surface structure. Traces  $t$  are introduced at the origin (and, possibly, intermediate positions) of the moved element and taken to be coindexed with it. The following examples illustrate that binding theory yields the right predictions given that, as stated by GB theory, “*Wh*” traces are assumed to be subject to binding principle B:

- (7a) *[Who<sub>i</sub>] does his<sub>i</sub> mother love t<sub>i</sub>?*  
 (7b) \* *[Who<sub>i</sub>] does he<sub>i</sub> love t<sub>i</sub>?*  
 (7c) *[Which picture of himself<sub>j</sub>]<sub>i</sub> does John<sub>j</sub> like t<sub>i</sub>?*

Whereas, in case (7a), the trace  $t$  might be coindexed with the possessive  $his_i$ , which constitutes a non-finite local domain of binding, in case (7b), the coindexing of  $t$  with the subject  $he_i$  of the embedded clause is ruled out as the latter would locally bind the former, thus violating BP B. Example (7c) illustrates an even more subtle case in which the sole admissible antecedent candidate of the reflexive pronoun  $himself_j$  is only available at the original position of the moved element. Thus, properly accounting for the binding condition verification of the trace representing the moved element does not suffice; further means are regarded to be necessary in order to adequately care for anaphoric entities *contained in* the moved element.

In GB theory, so-called **pro** elements constitute a second type of empty categories. They are used for surface-structurally modeling certain instances of implicit (unrealized) finite clause subjects, which are observed in languages such as Italian (*pro-drop languages*). *pro* denotes a formal substitute of the subject; if the entity implicitly referred to by the omitted subject is realized somewhere else in the sentence, the *pro* element serves as an expletive that is coindexed with the other occurrence(s). Some examples for Italian (cited from Giorgi et al. (1990)) are:

<sup>7</sup>E.g., in German, participles employed as adjectives (*Gerundiva*) might give rise to local domains of binding.

- (8a) *pro<sub>i</sub> telefona.* (“He/she [determined by context] is phoning.”)  
 (8b) *pro<sub>i</sub> telefona lui<sub>i</sub>.* (“He is phoning.”)  
 (8c) *Gianni<sub>i</sub> ha detto che pro<sub>j</sub> arriverà [la propria<sub>i</sub> madre]<sub>j</sub>.*  
 “Gianni has said that his Mother will arrive.”

Due to theoretical reasons, *pro* elements are interpreted to be subject to binding principle B as well (see Chomsky (1986), p. 164). However, as has been already pointed out by Giorgi et al. (1990), additional means have to be taken not to interpret the configurations in cases such as (8b) and (8c) as violations of the binding principle (B or C) of the implicit subject’s postponed occurrence. Regarding binding condition verification, Giorgi et al. (1990) thus suggest that the local binding of the postponed subject through the respective *pro* element should be considered to be an admissible exempt case.

Whereas the coverage of *pro* elements might be considered to be of primarily theoretical importance, there is a third type of empty categories distinguished by GB theory the proper algorithmic treatment of which seems to be of higher practical relevance to anaphor resolution. The surface-structural model of certain types of infinitival complements is considered to contain so-called **PRO** elements, which, as above, represent formal substitutes for unrealized (implicit) subjects. These substitutes are required as the infinitival complement might contain further referential entities the anaphoric capabilities of which are determined by the index of the implicit entity. As illustrated by the following examples, depending upon the verb of the matrix clause (e.g., *promise* vs. *persuade*), the respective *PRO* element is considered to be coindexed either with the subject or the object of the matrix clause (*subject control* vs. *object control*); this determines the option for the referential interpretation of the type A pronoun, which requires a binder inside (local to) the infinitival complement:

- (9a) *The barber<sub>i</sub> promises the client<sub>j</sub> PRO<sub>i</sub> to shave himself<sub>i</sub>.*  
 (9b) \* *The barber<sub>i</sub> promises the client<sub>j</sub> PRO<sub>i</sub> to shave himself<sub>j</sub>.*  
 (9c) \* *The barber<sub>i</sub> persuades the client<sub>j</sub> PRO<sub>j</sub> to shave himself<sub>i</sub>.*  
 (9d) *The barber<sub>i</sub> persuades the client<sub>j</sub> PRO<sub>j</sub> to shave himself<sub>j</sub>.*

The binding-theoretical type of the *PRO* occurrence (either A or B) is considered to depend upon further contextual criteria.<sup>8</sup> However, regardless of the theoretical intricacies concerning the property of the *PRO* element itself,<sup>9</sup> the important observation to be made here is that the binding condition verification of anaphoric expressions occurring inside infinitival complements might require additional efforts. An adequate implementation of binding condition verification should hence account for this issue.

Thus, at least from a theoretical point of view, the proper algorithmic coverage of empty categories seems to be important since, in general, they are a priori coin-

<sup>8</sup>BP B is assumed to be applicable in case there is no further local occurrence coindexed with the *PRO* element (so-called *arbitrary control*). See von Stechow and Sternefeld (1988).

<sup>9</sup>There have been further attempts to deal with this issue by singling out the proper treatment of *PRO* into a separate theory (*control theory*).

dexed with other non-empty categories and therefore transitively co-determine the antecedent options of anaphoric occurrences of all three binding-theoretic types. In order to adequately capture the binding conditions contributed by empty categories, dealing with decision interdependency (as defined in section 2.2.2) plays an important role, since the a-priori coindexing of these elements can be technically conceived as already performed and, hence, potentially interdependent antecedent decisions. Clearly, however, while a proper algorithmic account of binding should thus be able to accommodate the processing of empty categories, it is evident that, in the application case of robust anaphor resolution, much depends upon the descriptiveness of the employed parser's output.

### 2.3 Formal requirements upon binding condition verification

As the above discussion has shown, binding theory formally models sets of valid index assignments rather than making predictions on individual instances of anaphoric reference. Hence, it implicitly covers forward as well as backward anaphora. In order to adequately support anaphor resolution, suitable algorithmic accounts of binding should as well cover both cases of anaphora and deal with expressions of all three binding-theoretic types (A, B, and C), which all might play the role of an anaphor or antecedent candidate. Moreover, the implementation of the binding principles should be complete. However, as will become evident in the subsequent survey, some prominent algorithmic approaches to binding comply with these requirements only to a certain extent. The same holds with respect to the more intricate issues of non-finite local domains of binding and, in particular, decision interdependency and empty categories.

## 3 Algorithmic Approaches to Binding

### 3.1 Chomsky's original algorithm: the free indexing rule

As part of his original exposition of BT, Chomsky (1981) describes a generate-and-test approach for identifying the subset of index assignments that comply with the binding constraints. As it enumerates *all* possible index assignments and tests them for compliance with BT, this algorithm has a runtime complexity exponential in the number of NPs and empty categories in the surface structure tree. Since it accounts for all issues identified in section 2.2 (including empty categories), this algorithm can be considered a valid implementation of binding. However, as it does not give a detailed account of how to efficiently check for the validity of particular index assignments, it does not directly contribute to solving the problem of BT verification for robust anaphor resolution. Most importantly, however, it does not contribute to referential *disambiguation* as addressed by anaphor resolution in the sense that it considers index assignments valid in which anaphoric entities remain unresolved, as in

(10) *The barber<sub>i</sub> admits that he<sub>j</sub> shaves himself<sub>j</sub>.*

as BT merely enforces the selection of coindexed local governors for type A pronouns, but doesn't enforce coindexing of type B or C occurrences.

Put in a different way, in enumerating all admissible index assignments, free indexing does more than required for anaphor resolution, thus being computationally expensive, while, at the same time, it does less than required as it does not address the issue of identifying index assignments in which anaphoric entities are properly disambiguated.

### 3.2 The scope of other approaches

Various approaches have been suggested that address the inefficiency and the limited scope of free indexing. Commonly, these approaches circumvent the exponential time complexity of free indexing by restricting themselves to determine *locally* packed representations of the *individual* coindexing options for the occurrence-introducing nodes of the surface structure tree; lists of admissible *combined* index assignments are not generated. This comes at the expense of reduced coverage of the above requirements. In order to identify the most common limitations, four approaches that have received considerable attention in the literature on BT and anaphor resolution will be analyzed in more detail.<sup>10</sup>

#### 3.2.1 The approach of Correa

*Correa (1988)* employs a single traversal of the parsing tree and combines the assignment of individual sets of admissible antecedent candidates with a simple recency-based antecedent selection rule. In doing so, the conceptual distinction between the computation of admissible index assignments (as addressed by the free indexing rule) and the computation of antecedents (as addressed by anaphor resolution) gets blurred. Moreover, the approach does not cover instances of backward anaphora, and it does not deal with cases of decision interdependency, as mutually incompatible antecedent decisions are not recognized. Furthermore, BP C is not accounted for, and the implementation of BP B can be shown to be only partial. As this algorithm doesn't check for interdepending decisions, empty categories (which are, in general, a priori coindexed with further local occurrences) are not adequately covered either. However, at least it explicitly accounts for cases like (7c) above in which anaphors occur in moved elements: the search for configurationally admissible antecedents is extended to cover the original position of the moved element, which is now inhabited by the "Wh" trace. Nevertheless, the scope of this account can be shown to be merely partial, as, in cases like the following, it is not taken into account that the moved element itself already contains an (accessible) local subject, and, thus, the binding category of the reflexive pronoun:

(11) [Which of Peter's<sub>k</sub> pictures of himself<sub>k</sub>]<sub>i</sub> does John<sub>j</sub> like t<sub>i</sub>?

---

<sup>10</sup>The results of a related investigation that covers further algorithmic accounts of binding are presented by Branco (2002). However, whereas Branco (2002) considers this issue from a mainly theoretical point of view (e.g., assessing the conceptual repercussions of intragrammatical vs. extragrammatical localization of binding processing), the work presented here focusses on the algorithmic aspects of binding condition verification in the context of robust anaphor resolution.

Clearly, in such cases, wrong results would be obtained if the search for binding-theoretically admissible antecedents were extended to cover the position of the trace. This illustrates that non-finite local domains of binding are not properly dealt with either.

### 3.2.2 The approach of Ingria and Stallard

*Ingria and Stallard (1989)*, too, stay at the intragrammatical level of computing *locally* packed representations of *individual* admissible coindexings, as they do not address the problem of further referential disambiguation. Hence, they do not resolve the issue of decision interdependency, and, as a consequence, they do not properly account for empty categories. In fact, Ingria and Stallard (1989) themselves identify the lack of an adequate treatment of “*Wh*” traces as one of the major shortcomings of their algorithm (p. 269). However, this approach adequately covers instances of backward anaphora; moreover, the algorithm is particularly efficient and conceptually compelling.

### 3.2.3 The approach of Giorgi, Pianesi, and Satta

*Giorgi et al. (1990)* suggest two efficient algorithms for verifying binding conditions. Again, in looking at binding condition verification for type A and type B pronouns from the point of view of *individual* decisions, their approach exhibits the limitation of not resolving instances of interdepending decisions. While they are recognizing the importance of this issue (p. 124): “[...] *it is necessary to put together the constraints that have been separately computed for each item according to principles A and B (and C);*”, they nevertheless do not propose an algorithmic solution to this (ibid.) “*problem of BT verification, i.e. whether a given index assignment for the NPs of a sentence complies with the restrictions of BT*”. Thus, like the above-discussed approaches, the algorithm of Giorgi et al. (1990) exhibits the shortcoming of not adequately dealing with empty categories. However, at least this open problem is acknowledged as they discuss the proper treatment of *pro* elements, which is a major issue in their mother language (Italian). Moreover, as already mentioned in section 2.2.5, in suggesting that the local binding of the postponed subject through the respective *pro* element should be considered an admissible exempt case, they provide a partial solution that already covers some of the aspects relevant for dealing with *pro* elements.

### 3.2.4 The approach of Lappin and McCord

*Lappin and McCord (1990b,a)* describe an approach employing shared PROLOG variables for modeling reference index distributions, which can be considered a valid solution to the decision interdependency problem based on the PROLOG unification engine. As their grammar covers “*Wh*” traces, these type of empty categories is implicitly accounted for as well. The shared PROLOG variables can be understood as representations of the respective discourse referents. While this approach thus elegantly addresses the issue of decision interdependency and (at least

partially) empty categories, it doesn't make available explicit representations of individual occurrences. As anaphor resolution amounts to more than a mere checking for configurational admissibility, this can be regarded a serious shortcoming, as the local properties of the individual occurrences turn out to be of high relevance as well. Hence, this representation has to be properly extended, which seems to be achieved best outside the original PROLOG framework.

### 3.3 Binding condition verification for anaphor resolution

The above analysis reveals that prominent algorithmic approaches to binding exhibit serious limitations: (a) in general, as the issue of conflicting individual instances of coindexing is not resolved, the implementation is only partial, and empty categories are not adequately dealt with either; (b) binding principles B and C might be incompletely covered; (c) in addition, the algorithm of Correa (1988) does not deal with backward anaphora. In particular, the problem of referential disambiguation proper is not addressed.

However, if one takes a closer look at the particular requirements of anaphor resolution, as the set-out goal is the determination of *one particular* index assignment that models a plausible referential interpretation, it turns out that it is not required to emulate the *generate all* part of free indexing. Nor is it necessary to compute locally packed representations of all admissible antecedents as done by most of the approaches considered in section 3.2. Rather, it is required to perform referential disambiguation proper, i. e. to compute *one* admissible antecedent for each anaphor, and to employ further means to ensure that the combination of the individual decisions is consistent. Since, however, referential disambiguation generally employs further extragrammatical sources of evidence, this problem should be addressed by properly integrating the binding condition verification algorithm with further anaphor resolution strategies, which are commonly divided into filters and preferences (see Carbonell and Brown (1988)).

## 4 Anaphor Resolution with Robust BC Verification

Before proceeding with the formal specification of an efficient anaphor resolution algorithm that accomplishes the task of adequately verifying the binding conditions, the issue of robustness deserves further discussion. The above approaches implicitly assume that there is a sole complete and unambiguous surface-syntactic tree over which the computation of the binding conditions is performed. In general, in the scenario of algorithmic anaphor resolution, this requirement will not be met, as robust parsers typically yield fragmentary or ambiguous results.

### 4.1 Fragmentary syntax

First, there are the various types of *structural ambiguity* that give rise to partial parsing output: uncertainty of syntactic function (involving subject and direct object) and *attachment ambiguities* of prepositional phrases (exemplified by the well-known *telescope* sentences), relative clauses, and adverbial clauses. From the con-



figural perspective, since, in general, robust state-of-the-art parsers don't yield packed representations of structural ambiguity, these ambiguities typically give rise to *fragmentary syntactic descriptions* which consist of several tree-shaped components. With the exception of the topmost tree fragment, all components correspond to constituents of type PP, S, or NP whose attachment or role assignment failed. Second, *cases in which no reading exists* give rise to fragmentary descriptions comprising the constituents whose combination failed due to constraint violation.<sup>11</sup>

## 4.2 Verifying binding conditions on fragmentary syntax

Since the binding condition verification procedure refers to the surface-syntactic structure, it is potentially affected through the fragmentation of the parser's output. Thus, in the application context of *robust* anaphor resolution, further efforts are necessary. The first step towards the verification of binding constraints on fragmentary syntax is suggested by the following observation:

*If both the anaphor and the antecedent candidate are contained in the same connected component of the fragmentary syntactic description, no (direct) binding theoretic evidence is lost.*

In this case, the verification of the binding restrictions of anaphor and antecedent will be possible in a non-heuristic manner, since the necessary positive ( $\rightarrow$  binding principle A) and negative ( $\rightarrow$  binding principles B, C) syntactic-configurational evidence is entirely available.<sup>12</sup>

However, even in the disadvantageous case in which the anaphor and the antecedent candidate occur in different surface structure fragments, a closer look at the fragments may reveal additional information. In the following example, a typical case is illustrated:<sup>13</sup>

(12) *Der Mann hat den Präsidenten besucht, der ihn von sich überzeugte.*  
*The man has the president visited, who him of himself convinced.*  
*“The man has visited the president who convinced him of himself.”*

Because of the intervening past participle, the relative clause may be interpreted as an attribute to either *Mann* or *Präsidenten*. Hence, syntactic ambiguity arises, yielding a surface structure description which consists of two fragments

(S Mann (VP Präsident)) (S der (VP ihn (VP (PP sich))))

<sup>11</sup>In both classes of cases, syntactic deficiency results either because the input itself is ambiguous or deficient, or due to shortcomings of the processing resources, e.g. lexicon, grammar/parser, or semantic/pragmatic disambiguation.

<sup>12</sup>This statement, however, solely applies to the direct comparison of the involved occurrences, since in case of further, transitive coindexings, negative evidence stemming from decision interdependency may get lost (cf. section 2.2.2).

<sup>13</sup>The example is given in German because the structural ambiguity comes out more strikingly.

[F1]	✓	$\{ \dots F_i = [\dots bc(\gamma)(\dots \gamma_{type\ B} \dots)] \dots, \dots$ $\dots F_j = [\dots bc(\alpha)(\dots \alpha_{type\ B} \dots)] \dots \}$
[F2]	*	$\{ \dots F_i = [\dots bn(\gamma)(\dots \gamma_{type\ A/B/C} \dots)] \dots, \dots$ $\dots F_j = [\dots bc(\alpha)(\dots \alpha_{type\ A} \dots)] \dots \}$
[E1a]	✓	$\{ \dots F_d = [\dots \gamma_{type\ A/B/C} \dots], \dots$ $\dots F_e = [\dots bc(\alpha)(\dots \alpha_{type\ B} \dots)] \dots \}$
[E1b]	✓	$\{ \dots F_d = [\dots \alpha_{type\ B/C} \dots], \dots$ $\dots F_e = [\dots bc(\gamma)(\dots \gamma_{type\ B} \dots)] \dots \}$
[E2]	*	$\{ \dots F_d = [\dots \gamma_{type\ A/B/C} \dots], \dots$ $\dots F_e = [\dots bc(\alpha)(\dots \alpha_{type\ A} \dots)] \dots \}$
[E3a]	*	$\{ \dots F_d = [\dots \gamma_{type\ A/B/C} \dots], \dots, F_e = [\dots \alpha_{type\ C} \dots] \dots \}$ , if $\gamma$ c-commands $\alpha$ regardless of the attachment choice
[E3b]	*	$\{ \dots F_d = [\dots \alpha_{type\ A/B/C} \dots], \dots, F_e = [\dots \gamma_{type\ C} \dots] \dots \}$ , if $\alpha$ c-commands $\gamma$ regardless of the attachment choice
[E4]	*	$\{ \dots F_d = [\dots \alpha_{type\ A} \dots], \dots, F_e = [\dots bn(\gamma)(\dots \gamma_{type\ A/B/C} \dots)] \dots \}$

Figure 1: rule patterns for binding constraint verification on fragmentary syntax

In addition, it is known that the second fragment is embedded in the first. There are three pronominal anaphors to be resolved: the reflexive pronoun *sich* of type A, the nonreflexive pronoun *ihn* of type B, and the relative pronoun *der* of type B.

Regarding the reflexive pronoun *sich*, it can be shown that binding theoretic evidence is completely available. Clearly, this holds with respect to the candidates *der* and *ihn*, which are contained in the same surface structure fragment. However, even regarding the two candidates *Mann* and *Präsident* that occur in the other fragment, there is no loss of evidence: since the reflexive pronoun is of binding theoretic type A, and the fragment in which it occurs contains its binding category (the S node of the relative clause), according to binding principle A both candidates may be definitively *ruled out*.

Similar observations can be made regarding the pronouns *ihn* and *der*, for which binding principle B applies: the two candidates *Mann* and *Präsident* are recognized as configurationally *admissible*. In this case, besides the binding category condition, it is decisive that their fragment is known to be *embedded* in the antecedent's fragments.<sup>14</sup>

### 4.3 Rule patterns

In the subsequent discussion, pairs of anaphors  $\alpha$  and antecedent candidates  $\gamma$  are considered that occur in different surface syntactic fragments. The goal consists in determining whether coindexing  $\alpha$  and  $\gamma$  (as in case of actually choosing  $\gamma$  as the antecedent of  $\alpha$ ) complies with the above stated binding-theoretic conditions. Since, according to the definition of the binding conditions, no asymmetric distinc-

<sup>14</sup>It is evident that there are cases in which the latter condition does not hold and the coindexing would violate binding principle C.

[F1]	BP B of $\alpha / \gamma$ is satisfied	$\gamma$ does not <i>locally</i> bind $\alpha \wedge \alpha$ does not <i>locally</i> bind $\gamma$
[F2]	BP A of $\alpha$ is violated	$\gamma$ does not <i>locally</i> bind $\alpha \vee \gamma$ does not c-command $\alpha$
[E1a]	BP B of $\alpha$ is satisfied	$\gamma$ does not <i>locally</i> bind $\alpha$
[E1b]	BP B of $\gamma$ is satisfied	$\alpha$ does not <i>locally</i> bind $\gamma$
[E2]	BP A of $\alpha$ is violated	$\gamma$ does not <i>locally</i> bind $\alpha$
[E3a]	BP C of $\alpha$ is violated	$\gamma$ c-commands $\alpha$
[E3b]	BP C of $\gamma$ is violated	$\alpha$ c-commands $\gamma$
[E4]	BP A of $\alpha$ is violated	$\gamma$ does not c-command $\alpha$

Figure 2: binding theoretic background of the rule patterns

tion between anaphor and candidate is drawn, the disjoint reference requirements of both  $\alpha$  and  $\gamma$  have to be taken into account.

By an abstraction over cases like the ones discussed in section 4.2, a set of *rule patterns* can be designed by means of which the verification of syntactic disjoint reference is generalized in order to make it applicable to fragmentary syntactic descriptions (cf. figure 1).<sup>15</sup> It is distinguished between whether or not it is known that one fragment is subordinated to the other: patterns [E1a] to [E4] only match configurations in which  $F_d$  is known to be the *dominating* and  $F_e$  the *embedded* fragment; patterns [F1] and [F2], on the other hand, match arbitrary cases. As illustrated by the above example (12), the patterns either make a positive or a negative prediction.<sup>16</sup> One class (five patterns, labeled “\*”) matches cases in which, according to the binding principles, coindexing the anaphor  $\alpha$  and the antecedent candidate  $\gamma$  is *ruled out*; the other class (three patterns, labeled “√”) applies in certain cases where there is no violation of any binding principle, and, hence, coindexing is *admissible*. By the binding principles, conditions regarding, on one hand, the *presence or absence of a c-command relation*, and, on the other hand, the *locality or non-locality* of this relation, are stated. The rule patterns are designed to match fragmentary cases in which at least one condition of either anaphor or candidate is violated (“\*” patterns), or, respectively, cases in which all conditions of anaphor and candidate are satisfied (“√” patterns). In figure 2, the specific conditions are explicated which the different patterns aim at. There are three patterns that apply in certain cases of BP A violation ([E2]: missing locality; [E4]: missing c-command relation; [F2]: either missing locality or missing c-command relation). Another two patterns cover instances of BP C violation ([E3a], [E3b]: c-command

<sup>15</sup>The following notational conventions are used: round brackets delimit constituents; square brackets emphasize fragment boundaries;  $bc(X)$  denotes the binding category of surface structure node  $X$ ;  $bn(X)$  denotes the branching node dominating  $X$  according to the c-command definition; the subscript of  $X_{type Y}$  denotes that the binding theoretic class of the occurrence contributed by  $X$  is  $Y \in \{A, B, C\}$ , e.g.  $P_{type B}$  is a pronoun.  $\sqrt{}/*$  indicate the prediction of the respective pattern, i.e. whether, in structural configurations matching the pattern, coindexing is admissible/ruled out.

<sup>16</sup>Example (12) illustrates an instance of syntactic fragmentation that is due to structural ambiguity. The rule patterns, however, are general in the sense that they also cover cases of fragmentary syntactic description which are induced by parsing constraint violation (cf. section 4.1).

relation). Moreover, there are three patterns matching cases of BP B satisfaction ([F1], [E1a], [E1b]: non-locality). Two further rule patterns [IEa] and [IEb] (not shown in figure 1) match certain syntactic configurations in which a coindexing would violate the i-within-i condition (see Stuckardt (2001)).

The above collection of rules may be supplemented with further patterns employing more sophisticated conditions regarding the fragments to be matched. As will become evident during evaluation, the choice of rule patterns should depend on the employed parser (see section 4.6). The above set of patterns might suffice if the degree of fragmentation of the parsing results is low.

To illustrate the binding-theoretical background, three rule patterns that match the configurations of the above example (12) shall be discussed in detail.<sup>17</sup>

#### Rule patterns [E1a] and [E1b]

$$\begin{aligned} \checkmark & \{ \dots F_d = [\dots \gamma_{type\ A/B/C} \dots], \dots, F_e = [\dots bc(\alpha)(\dots \alpha_{type\ B} \dots)] \dots \} \\ \checkmark & \{ \dots F_d = [\dots \alpha_{type\ B/C} \dots], \dots, F_e = [\dots bc(\gamma)(\dots \gamma_{type\ B} \dots)] \dots \} \end{aligned}$$

match certain cases in which it is known that one fragment is (immediately or transitively) subordinated to the other ( $F_d$  = dominating fragment,  $F_e$  = embedded fragment). [E1a] states that if the fragment of the type B anaphor  $\alpha$  is subordinated and it contains the binding category of the anaphor, coindexing with an outside candidate  $\gamma$  (here: arbitrarily of type A, B, or C) is admissible. [E1b], on the other hand, matches cases in which the fragment of the type B (or type C) anaphor  $\alpha$  is known to be the dominator; here, a candidate  $\gamma$  of type B that occurs in a fragment containing its binding category is configurationally permitted.<sup>18</sup> Typical cases in which [E1a] and [E1b] apply are instances of structurally ambiguous relative clauses. In the above example (12), since the (embedded) relative clause fragment contains the binding category of the nonreflexive (type B) pronoun occurrences (taken as anaphors  $\alpha$ ), fragment  $F_e$  of rule [E1a] is instantiated; moreover, trivially, the (dominating) main clause instantiates  $F_d$  with respect to any of its (type C) occurrences (taken as candidates  $\gamma$ ). Hence, [E1a] applies, licensing the respective coindexings. Likewise, pattern [E1b] applies when considering the type C occurrences in the dominating fragment of example (12) as anaphors and the type B pronouns in the subordinated fragment as antecedent candidates.

#### Rule pattern [E2]

$$* \{ \dots F_d = [\dots \gamma_{type\ A/B/C} \dots], \dots, F_e = [\dots bc(\alpha)(\dots \alpha_{type\ A} \dots)] \dots \}$$

requires that the anaphor's fragment is known to be subordinated; under this condition, the presence of the reflexive pronoun's binding category in the embedded fragment proves to be sufficient for ruling out the candidate as the constructive

<sup>17</sup>For a description of the other patterns, the reader is referred to Stuckardt (2001).

<sup>18</sup>In the case of [E1b], the *anaphor* (i.e. the occurrence to be constructively resolved) occurs in the dominating fragment. Since  $\gamma$  cannot be a local binder of  $\alpha$ , the occurrence in the dominating fragment is not allowed to be of type A (cf. the remarks on strong vs. weak coindexing in section 2.2.3). Hence, since  $\alpha$  and  $\gamma$  are not interchangeable, [E1a] and [E1b] look slightly different.

antecedent required according to binding principle A. Again, applied to example (12), [E2] rules out the constructive coindexing of the reflexive pronoun with any candidate occurring in the main clause.

#### 4.4 Formal specification of the anaphor resolution algorithm

Based on the above set of rule patterns, an anaphor resolution algorithm can be designed that robustly accomplishes the verification of the binding conditions while complying with the requirements identified in section 2.2 (ROSANA<sup>19</sup> algorithm, see figure 3). In applying a set of *restrictions* (step 1) prior to a set of *preferences* (step 2), the fundamental strategy of Carbonell and Brown (1988) is followed by means of which the candidate set is narrowed down as early as possible. In step 3 of the ROSANA algorithm, the actual *selection* of antecedents takes place. Among the strategies to be applied are restrictions (e.g. morphosyntactic and lexical congruence, disjoint reference conditions) as well as a plethora of preference factors (subject/topicalization salience, syntactic obliqueness, recency, cataphor penalty, parallelism (inertia of syntactic function)) (see Stuckardt (2001) for a further discussion). The subsequent considerations focus on the issue of syntactic disjoint reference; in particular, it shall be explained how the robust verification of the binding conditions is dovetailed with the other anaphor resolution strategies, and how - or, to what extent - the requirements identified in section 2.2 are met.

#### 4.5 Discussion: compliance with the requirements

With respect to the verification of the binding conditions, the central goal of *robustness against fragmentary syntax* is achieved in steps 1b and 3b. As described above, if the considered occurrences are situated in different fragments, the rule patterns come into play; the actual set of patterns to be applied depends on whether it is known that one of the fragments is embedded in the other. Patterns labeled “\*” are employed to eliminate candidates (steps 1(b)iv and 1(b)v). Patterns marked “√” are used to *definitively* admit candidates (step 1(b)vi), contrasting the *heuristic* admittance (step 1(b)vii), which entails a plausibility decrement in step 2a.

The issue of *decision interdependency* is addressed in step 3. In explicitly checking for the binding theoretic admissibility of transitively induced coindexings, the algorithm guards against the combination of conflicting coindexings (step 3b). ROSANA thus solves the open problem of “*BT verification*” as identified by Giorgi et al. (1990) while avoiding the exponential time complexity of Chomsky’s free indexing rule. In compliance with the above identified requirement to distinguish between *strong (constructive) and weak (non-constructive) verification of BPA*, the decision interdependency test step employs the weak version of this test, which amounts to not blocking *further* (possibly non-local or non-binding) coindexings of type A anaphors. The same distinction is drawn in step 1b: whereas the binding restriction of the anaphor is verified in the strong, constructive sense (step 1(b)i), the candidate’s restriction is applied in its weak version (step 1(b)ii). In the rule patterns for the fragmentary case, this subtlety is reflected implicitly in the

---

<sup>19</sup>ROSANA = **R**obust **S**yntax-Based Interpretation of **A**naphoric Expressions

1. *Candidate Filtering*: for each anaphoric NP  $\alpha$ , determine the set of admissible antecedents  $\gamma$ :
  - (a) verify morphosyntactic or lexical agreement with  $\gamma$ ;
  - (b) if the antecedent candidate  $\gamma$  is intrasentential:
    - if  $\alpha$  and  $\gamma$  belong to the same syntactic fragment, then verify that
      - i. the binding restriction of  $\alpha$  is constructively satisfied,
      - ii. the binding restriction of  $\gamma$  is not violated,
      - iii. no i-within-i configuration results;
    - else ( $\alpha$  and  $\gamma$  belong to different syntactic fragments) *try the rule patterns*:
      - iv. if one of the patterns [E2], [E3a], [E3b], [E4], or [F2] is matched, then some binding restrictions are violated,
      - v. else if one of the two i-within-i rule patterns [IEa] or [IEb] applies, then some binding restrictions are violated,
      - vi. else if pattern [E1a], [E1b], or [F1] applies, then the binding restrictions of  $\alpha$  and  $\gamma$  are satisfied,
      - vii. else (*no rule pattern applies*) assume heuristically that the binding restrictions of  $\alpha$  and  $\gamma$  are satisfied;
  - (...) Further restrictions might apply (see Stuckardt (2001)).
2. *Candidate Scoring and Sorting*:
  - (a) for each remaining anaphor-candidate pair  $(\alpha_i, \gamma_j)$ : based on a set of preference heuristics, determine the numerical plausibility score  $v(\alpha_i, \gamma_j)$ .  
If the binding theoretic admissibility was approved *heuristically* in step 1(b)vii, then reduce the plausibility score  $v(\alpha_i, \gamma_j)$  by a constant value;
  - (b) for each anaphor  $\alpha$ : sort candidates  $\gamma_j$  according to decreasing plausibility  $v(\alpha, \gamma_j)$ ;
  - (c) Sort the anaphors  $\alpha$  according to decreasing plausibility of their respective best antecedent candidates.
3. *Antecedent Selection*: consider anaphors  $\alpha$  in the order determined in step 2c. Suggest antecedent candidates  $\gamma_j(\alpha)$  in the order determined in step 2b. Select  $\gamma_j(\alpha)$  as candidate if there is no interdependency, i.e. if
  - (a) the morphosyntactic features of  $\alpha$  and  $\gamma_j(\alpha)$  are still compatible,
  - (b) for all occurrences  $\delta_{\gamma_j(\alpha)}$  and  $\delta_\alpha$  the coindexing of which with  $\gamma_j(\alpha)$  and (respectively)  $\alpha$  has been determined in the *current* invocation of the algorithm: the coindexing of  $\delta_{\gamma_j(\alpha)}$  and  $\delta_\alpha$ , which results transitively when choosing  $\gamma_j(\alpha)$  as antecedent for  $\alpha$ , does neither violate the binding principles nor the i-within-i condition, i.e.
    - if  $\delta_{\gamma_j(\alpha)}$  and  $\delta_\alpha$  belong to the same syntactic fragment, then, for both occurrences, verify the respective binding conditions and the i-within-i condition according to steps 1(b)ii and 1(b)iii,
    - else if  $\delta_{\gamma_j(\alpha)}$  and  $\delta_\alpha$  belong to different syntactic fragments, then proceed according to steps 1(b)iv, 1(b)v, 1(b)vi, and 1(b)vii (with the exception of the rule patterns [F2], [E2], and [E4], by means of which binding principle A is *constructively* verified).

(The case  $\delta_{\gamma_j(\alpha)} = \gamma_j(\alpha) \wedge \delta_\alpha = \alpha$  does not need to be reconsidered.)

Figure 3: the ROSANA anaphor resolution algorithm

sense that only regarding occurrence  $\alpha$  (taken as the anaphor to be constructively resolved), the strong version of BP A is checked; hence, in the interdependency test step 3b, patterns [F2], [E2], and [E4] are not taken into consideration.

Thus, the issues of decision interdependency and *strong vs. weak verification of BP A* are properly accounted for. Since, in steps 1b and 3b, the *antecedent's* binding condition is verified, the *symmetry of the binding-theoretic predictions* is taken into account as well. Clearly, as there is no asymmetric one-pass tree search, the algorithm adequately deals with instances of cataphora, and the implementation of binding principles A, B, and C can be regarded to be complete.

It shall now be discussed whether - or, to what extent - the ROSANA algorithm accounts for the various types of *empty categories*. In providing a mechanism for efficiently checking for decision interdependency, ROSANA properly handles the a priori coindexings of “*Wh*” traces, *pro* elements, and *PRO* elements. Furthermore, the BC verification step of ROSANA might be straightforwardly adapted in order to achieve an adequate processing of *pro* instances. These occurrences are binding-theoretically interpreted just like ordinary type B pronouns, but with two exceptions: (a) no antecedent search takes place; (b) it is *not* checked whether there is a binding of postponed occurrences through their respective *pro* expletives (see the discussion of the above examples (8b) and (8c)). Likewise, *PRO* elements are just considered as ordinary (depending upon type of control) type A or B occurrences for which no antecedent is sought, but which might themselves play the role of antecedents. The sole issue not covered by the current ROSANA BT verification mechanism that seems to necessitate a considerable extension regards the treatment of anaphors occurring *inside* moved elements as discussed above (examples (7c) and (11)) and partially taken into account by the algorithm of Correa (1988).

Typically, robust state-of-the-art parsers do not yield surface-structural descriptions containing empty categories because, for instance, the general algorithmic recognition of instances of “*Wh*” movement or the decision whether a particular *PRO* occurrence is controlled by the subject or the object are intricate problems that are known to involve knowledge well beyond the surface-syntactic level. However, the central point to note here is that the ROSANA BT verification algorithm, while being efficient, fulfils all main requirements of an adequate processing of these types of occurrences (as far as they are made available by the parser), and hence has a considerably broader scope than the other approaches discussed in section 3.

Finally, regarding *non-finite local domains of binding*, the ROSANA algorithm covers them as well. In general, the output of robust state-of-the-art parsers is sufficiently informative so that cases like (6a..d), in which a possessive marker has to be interpreted as a logical subject, can be recognized and properly processed. However, further efforts are required in order to deal with more intricate cases such as (in German) adjectivally employed participles, where it might be necessary to assume the presence of an empty occurrence (a priori coindexed with the dominating NP) that represents the logical subject of the local domain. Essentially, these empty occurrences should be treated like empty categories; once again, the mechanism that checks for decision interdependency does most of the job.

## 4.6 Evaluation

Obviously, the direct evaluation of the BC verification strategy employed by any anaphor resolution algorithm imposes a problem, as much depends upon the chosen parser, and as, by now, no generally accepted evaluation corpus comprising test cases that cover all of the above identified requirements is available. Hence, an indirect, *extrinsic* evaluation will be carried out, looking at the problem of anaphor resolution in general, and determining the cases in which wrong antecedents are assigned *due to the failure of the above specified robust BC verification algorithm*. In the implementation put under scrutiny here, ROSANA works on the partial syntactic descriptions generated by the robust FDG (Functional Dependency Grammar of English) parser of Järvinen and Tapanainen (1997), which are further processed in order to integrate them with the data structures proper of referential processing (occurrences, discourse referents). The evaluation is carried out on a referentially annotated corpus of 35 news agency press releases, comprising 12904 words.<sup>20</sup>

A qualification of the failures of anaphor resolution gives evidence that, with respect to the fragmentary descriptions generated by the chosen parser, the robust implementation of syntactic disjoint reference is nearly optimal. None of the 7 incorrect antecedent choices that are due to failures of the disjoint reference strategy (out of a total of 246 wrong antecedent choices for the evaluation corpus) are due to wrong predictions of the (still partly heuristic) algorithmisation of the binding theoretic restrictions; rather, they are caused by wrong (in contrast to fragmentary, i.e. partial) parsing results: while already employing defensive parsing strategies, the parser still overgenerates in certain cases. In 6 of the 7 disjoint reference failures, a configurationally admissible candidate has been erroneously eliminated; in the remaining case, a configurationally forbidden candidate has been erroneously approved. Hence, there is a tendency of overgenerating disjoint reference restrictions. A detailed analysis reveals that, in 4 of the 6 cases, the respective parsing error consists in a wrong interpretation of a structurally ambiguous relative clause. This indicates that, while the rate of disjoint reference failure is already very low (2.8% of all failures), a small improvement might be achieved by employing a more defensive parsing strategy with a slightly higher level of fragmentation, which, by now, amounts to an average of 2.61 fragments per sentence. It further illustrates that, as mentioned in section 4.3, the choice of rule patterns for robust syntactic disjoint reference should depend on the employed parser: a higher degree of parse fragmentation might give rise to extending the set of patterns.

## 5 Conclusion

According to the above analysis, the ROSANA BT verification algorithm can be considered to meet almost all of the requirements identified in section 2.2. Contrary to its competitors, the different binding principles and types of anaphora (forward

---

<sup>20</sup>The anaphor and coreference resolution results proper are provided in Stuckardt (2001) and at the ROSANA website: <http://www.stuckardt.de/rosana.htm>.



vs. backward) are adequately covered, and, most importantly, the problems of *BT verification* and *referential disambiguation proper* are solved: it is taken care of that (a) the computed index *distributions* (*combinations* of antecedent decisions) are valid, and that (b) every anaphoric occurrence is assigned an antecedent. This is accomplished by integrating the BT verification algorithm with a set of further filtering and preference strategies, thus guiding the antecedent selection process in order to arrive at a *single*, highly plausible, and valid index *distribution*, and, hence, avoiding the exponential time complexity of the free indexing rule. Regarding its extrinsic performance on the output of the robust parser of Järvinen and Tapanainen (1997) with respect to the task of anaphor resolution, it turned out that there is not much space for further improvement. Moreover, the algorithm proved to be computationally inexpensive. Thus, the practical requirements in the context of incomplete preprocessing are met as well.

Seen from a different perspective, the approaches of Correa (1988), Ingria and Stallard (1989), and Giorgi et al. (1990) chiefly address the efficiency issue of free indexing, which is resolved by restricting the considerations to the computation of *locally* packed representations of referential ambiguity (sets of configurationally admissible antecedent candidates of individual occurrences) and hence at the expense of not checking the *overall* validity of decision combinations. The ROSANA algorithm achieves efficiency *and* fully-fledged referential disambiguation; this, however, comes at the expense of restricting the output to a *single* valid index assignment. Thus, it is natural to ask whether an efficient algorithm might be designed that computes *non-locally* packed representations of binding-theoretically valid *combinations* of coindexings (index distributions), which can be considered the reference processing analogues of the packed shared forests that are employed for the lossless representation of ambiguous parses. In fact, declaratively encoding the BC verification in a sufficiently powerful unification-based formalism implicitly achieves this goal. From a theoretical point of view, such approaches might even be considered to exhibit a higher degree of robustness, as unification-based representations elegantly integrate different sources of grammatical evidence, which might all contribute to referential disambiguation (see Stuckardt (1997)).

## References

- Branco, António. 2002. Binding Machines. *Computational Linguistics* 28(1), 1–18.
- Carbonell, Jaime G. and Brown, Ralf D. 1988. Anaphora Resolution: A Multi-Strategy Approach. In *Proceedings of the 12th International Conference on Computational Linguistics (COLING)*, pages 96–101.
- Chomsky, Noam. 1981. *Lectures on Government and Binding*. Dordrecht: Foris Publications.
- Chomsky, Noam. 1986. *Knowledge of Language*. New York: Praeger.

- Correa, Nelson. 1988. A Binding Rule for Government-Binding Parsing. In *Proceedings of the 12th International Conference on Computational Linguistics (COLING)*, pages 123–129.
- Giorgi, Alessandra, Pianesi, Fabio and Satta, Giorgio. 1990. A Computational Approach to Binding Theory. In *Proceedings of the 13th International Conference on Computational Linguistics (COLING)*, pages 120–125.
- Hobbs, Jerry R. 1978. Resolving Pronoun References. *Lingua* 44, 311–338.
- Ingria, Robert J. P. and Stallard, David. 1989. A Computational Mechanism for Pronominal Reference. In *Proceedings of the 27th Annual Meeting of the Association of Computational Linguistics (ACL)*.
- Järvinen, Timo and Tapanainen, Pasi. 1997. A Dependency Grammar for English. Technical Report TR-1, Department of General Linguistics, University of Helsinki.
- Kennedy, Christopher and Boguraev, Branimir. 1996. Anaphora for Everyone: Pronominal Anaphora Resolution without a Parser. In *Proceedings of the 16th International Conference on Computational Linguistics (COLING)*, pages 113–118.
- Lappin, Shalom and Leass, Herbert J. 1994. An Algorithm for Pronominal Anaphora Resolution. *Computational Linguistics* 20(4), 535–561.
- Lappin, Shalom and McCord, Michael. 1990a. Anaphora Resolution in Slot Grammar. *Computational Linguistics* 16(4), 197–212.
- Lappin, Shalom and McCord, Michael. 1990b. A Syntactic Filter on Pronominal Anaphora for Slot Grammar. In *Proceedings of the 28th Annual Meeting of the Association for Computational Linguistics (ACL)*, pages 135–142.
- Mitkov, Ruslan. 1998. Robust Pronoun Resolution with Limited Knowledge. In *Proceedings of the 17th International Conference on Computational Linguistics (COLING'98/ACL'98), Montreal*, pages 869–875.
- Pollard, Carl and Sag, Ivan A. 1994. *Head-Driven Phrase Structure Grammar*. Stanford: CSLI Publications.
- Stuckardt, Roland. 1997. Resolving Anaphoric References on Deficient Syntactic Descriptions. In *Proceedings of the ACL Workshop on Operational Factors in Practical, Robust Anaphor Resolution for Unrestricted Texts*, pages 30–37.
- Stuckardt, Roland. 2001. Design and Enhanced Evaluation of a Robust Anaphor Resolution Algorithm. *Computational Linguistics* 27(4), 479–506.
- von Stechow, Arnim and Sternefeld, Wolfgang. 1988. *Bausteine syntaktischen Wissens*. Westdeutscher Verlag.